

The Wireless World

THE
PRACTICAL RADIO
JOURNAL
23rd Year of Publication

No. 736.

FRIDAY, OCTOBER 6TH, 1933.

VOL. XXXIII. No. 14.

Proprietors: ILIFFE & SONS LTD.

Editor:
HUGH S. POCOCK.

Editorial,
Advertising and Publishing Offices:
DORSET HOUSE, STAMFORD STREET,
LONDON, S.E. 1.

Telephone: Hop 3333 (50 lines).
Telegrams: "Ethaworld, Watloo, London."

COVENTRY: Hertford Street.

Telegrams: "Cyclist, Coventry." Telephone: 5210 Coventry.

BIRMINGHAM:

Guildhall Buildings, Navigation Street, 2.
Telegrams: "Autopress, Birmingham." Telephone: 2070 Midland (3 lines).

MANCHESTER: 260, Deansgate, 3.

Telegrams: "Iliffe, Manchester." Telephone: Blackfriars 4412 (4 lines).

GLASGOW: 26B, Renfield Street, C.2.

Telegrams: "Iliffe, Glasgow." Telephone: Central 4857.

PUBLISHED WEEKLY. ENTERED AS SECOND
CLASS MATTER AT NEW YORK, N.Y.

Subscription Rates:

Home, £1 rs. 8d.; Canada, £1 rs. 8d.; other
countries abroad, £1 3s. 10d. per annum.

As many of the circuits and apparatus described in these
pages are covered by patents, readers are advised, before
making use of them, to satisfy themselves that they would
not be infringing patents.

CONTENTS

	Page
Editorial Comment	279
The Autumn Spring Clean	280
Identifying Valve Connections	282
Distant Reception Notes	283
Unbiased	284
The Wireless World A.V.C. Three	285
News of the Week	286
PROGRAMMES FROM	
ABROAD I-XXIV	
Broadcast Brevities	287
Television Progress	288
McMichael Twin-Supervox	291
D.C. Superhet	292
Laboratory Tests	295
Readers' Problems	296

EDITORIAL COMMENT

Broadcast Call-signs Re-identification with Lucerne Changes

IN last week's issue we referred to a proposal put forward by a reader that call-signs should be adopted by the broadcasting stations of Europe, to be used in frequent announcements on the same lines as has been long in use in America, for the purpose of enabling the listeners to identify the stations. Far too little attention has been paid to this matter in Europe, and there is no justification for assuming that the public is not interested in identification of the stations from which emanates any particular programme to which they may be listening.

Even if objections may be raised to introducing a comprehensive scheme throughout Europe, there is still every reason why all stations changing wavelengths according to the Lucerne Plan in January next should, at least for some weeks, take special steps to help their listeners in the task of re-identification.

Television

B.B.C. Will Carry On

A NEW television scare has been started with the suggestion that the B.B.C. intends to discontinue television transmissions. The true facts are that there is an agreement between the B.B.C. and the Baird Company, under which the B.B.C. undertakes to conduct transmissions by the Baird system for a certain period. This period and the agreement expire in 1934, and no information has yet been given as to renewal or revision. Some people have therefore jumped to the conclu-

sion that the B.B.C. is abandoning television as from that date.

Far from abandoning television, we can safely say that the B.B.C. was never more actively interested in the project than now, but we must move with the times and improve upon the present transmissions as technical progress justifies it. Even when a short-wave system comes into use for regular transmission with greater detail of picture, it is quite likely that the present 30 line Baird transmissions will also be retained as a standby and an alternative to the more promising systems now being developed, in particular by the Baird Company.

Foreign Programmes

A Special Supplement

WITH this week's issue we commence the publication of the full programmes for the week from Continental and other stations abroad, in the form of a Special Supplement on coloured paper, and this information will be continued week by week in this form. We believe that the interest of our readers in foreign station reception during the coming winter will be greater than ever before, because stations have increased in power and in quality of their programmes, whilst at the same time improvements in receivers have helped to bring a very large number of the Continental stations up to a strength equal to the local.

There is also included with this issue another useful Supplement, in the form of a 32-page booklet of Practical Hints and Tips, which we believe will be found of great value, especially at this time of the year when so many listeners begin to take a more practical and intimate interest in their sets in preparation for winter listening.

The Autumn Spring Clean

Or, Can You Do Without a 1934 Model?

DURING a summer such as we have been enjoying this year the wireless set is likely to have missed the periodical tuning up which it might have expected to receive during wet week-ends. Now that autumn is here we should give the set a thorough overhaul and decide if its standard is high enough for the winter service we expect from it.

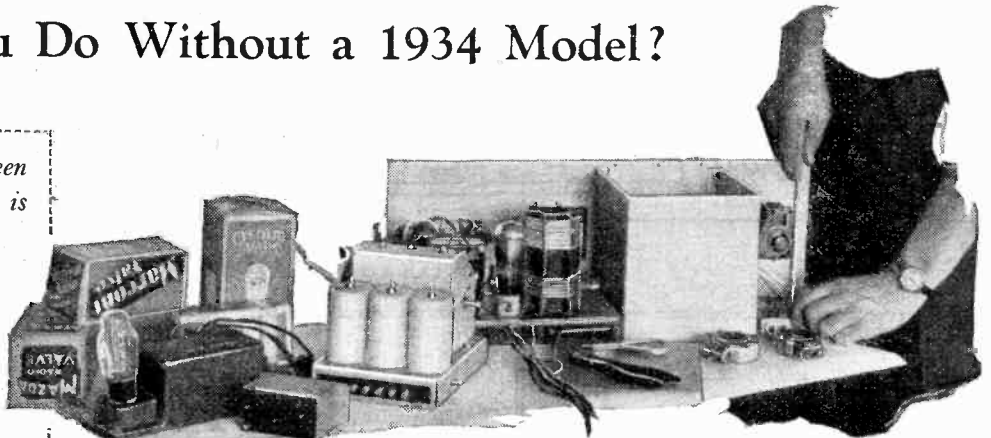

If the set is an old one a complete overhaul and some replacements will be necessary.

ONE of the functions of the cinema is to enable those who, for various reasons, are denied the delight of love-making, to enjoy it vicariously by watching the perfect technique displayed on the screen, and, in doing so, to forget for a time their own limitations. In the same way, relatively few among the crowds that recently flocked to Olympia went there with the knowledge that they could select an up-to-date model; the others had to be content to be thrilled in imagination. Yet need they? The old set that has been accumulating dust during this sunny summer may be showing a few wrinkles and grey hairs, but the job of rejuvenating it will be more interesting than buying something ready made, and the result may not be far behind it in performance. There is a tremendous amount of satisfaction to be gained from making sure that everything is in perfect tune, and perhaps discovering quite unexpected merits by clearing faults that had lain hidden.

Of course, it is quite impossible to explain in detail all that might be done to every possible type and vintage—single-valve, straight-three, portable, superhet, short-wave, radio-gram, battery, A.C., D.C., and perhaps even crystal or coherer—so what follows is intended to give suggestions; most of the details can be gleaned from back numbers of *The Wireless World*.

Testing Contacts

Beginning with what can be done at little or no cost, we shall go on to suggest more organic modernisations, yet short of the expense of a new receiver.

One of the most comprehensive items in any overhaul can be summed up in one word—Contact. If the wiring has been carried out really well in the first event it should last indefinitely—apart from severe knocking about, of chemical corrosion. But, rather than chance this, it is wise to test the soundness of all soldered joints by tugging at them with sharp-nosed

pliers, and giving all screw contacts a shrewd twist. Valve sockets and pins can often do with a little opening out or adjustment, and the same applies to other plug connections. And, while on the subject of connections, how about tidying them up generally? There are firms who have specialised for years in perfecting all sorts of terminals and connectors, and the result of a few shillings spent on their products will certainly show a vast improvement in appearance over improvised joints and leads, and may save interruptions, due to a "technical hitch," in vital programmes. At the same time, it is not a bad idea to include a set of uniform knobs, which several manufacturers now supply, to substitute for the odd lot seen on the panels of so many home-built sets.

POINTS TO WATCH

- Dust and dirt anywhere
- Disconnections in wiring
- Bad contacts in switches
- Aerials and earths with bad or intermittent connections
- Grid batteries worn out
- Run-down H.T. batteries
- Noisy volume controls
- Valves

An entirely trouble-free team of switches is sufficiently rare to make inspection of these components an essential feature of even a perfunctory overhaul. Those in H.F. circuits, particularly if they carry no D.C., and heavy-current contacts, are the most likely to need cleaning and adjustment. The contact pressure should be firm, but not excessive, for any action that roughens or grinds the contact surfaces defeats its object. For the same reason the contacts should *not* be cleaned with a file or even ordinary emery paper, which should be reserved for trimming rough surfaces. The contacts should be finally smoothed and cleaned with the finest "blueback" and then burnished

with clean polished steel such as the back of a knife.

Rheostats and volume controls often develop noisiness. This is seldom due to dirt, for that can be removed by one or two rotations; but the turns of wire on the resistance element sometimes loosen and cause irregular contact. After coaxing them into position where the arm rides over them, the adjacent parts of the wire can be stuck down with varnish, taking care to remove any that strays on to the contact surface.

Importance of the Aerial

The earth connection is usually in some position that for inspection necessitates a bent back and dusty knees, and is therefore left to look after itself. The need for an extremely efficient aerial-earth system is not felt so keenly as it used to be, because so much more amplification is on tap; but that very reason makes a good earth all the more desirable, to avoid hum and instability. Similarly, it is not so important now that the aerial should be able to pull in a lot of signal strength, but it is very important that it should be entirely free from bad or casual contacts such as rubbing on a roof edge or any blemish that would introduce noisiness or fluctuation. On the short waves these faults are the more important, and noise can be caused by bad contacts in metal objects that have nothing whatever to do with the receiving system, if they happen to be anywhere near.

Batteries, where used, will certainly require attention. Instead of just recharging the accumulator, have the acid that has served it for so many years renewed, and the terminals cleaned and revaselined. There is nothing much one can do to a dry H.T. except to renew it when necessary, but an accumulator H.T. requires attention, if one is not to be involved in heavy renewal expense. And sometimes grid bias batteries fail rather suddenly, and unless replaced pretty quickly both quality and cash melt away. This is par-

The Autumn Spring Clean—

particularly true of Q.P.P. systems, or the bias for Class "B" drivers, which need careful supervision if the merits of these systems are not to be lost.

If batteries fall due to be renewed, and electricity is laid on, yet a complete mains set would unbalance the budget, try working out a little calculation to decide whether it is going to be more expensive to get a mains unit (or "eliminator") or to keep on buying batteries. Mains units are not so expensive as they used to be. If no supply is laid on, the best investment is a Class "B" unit, of which a selection is now available, and which can be coupled up and put into action in a minute or two.

New Valves

Valves are the most important, yet not the most permanent components. Moreover, there are all shades of condition between 100 per cent. and total collapse. Old age may creep on so gradually as to be unobserved. As has often been explained, the best single test of a valve is to measure the anode current with a milliammeter. This is particularly important in the output stage, and it is very difficult to get the best from push-pull and Q.P.P. systems unless the currents in each half are equalised and brought to the correct amount. Adjusting the bias, even of a single valve, is a blind process without a meter.

The commonest defects—apart from obvious ones, such as total failure—are noisiness and gradual loss of emission. The latter can be detected by a milliammeter, and the former by disconnecting the aerial or otherwise cutting out external sources of sound, and putting the receiver into its most sensitive condition. If the background is not perfectly silent, steps should be taken to find out why it isn't. There will be a certain inevitable hiss in superhets, and a slight residue of hum in mains sets. Some noise may be due to H.F. mains interference. The most likely valve to be noisy is the detector, and it should be gently tapped to show up looseness of internal elements. The H.F. valve or valves seldom reveal noisiness unless a carrier wave is being amplified by them, so after all the others have been dealt with they can be tested by tuning to the local station during an interval (a weak carrier

would probably be accompanied by noise of external origin).

If a valve replacement has to be made, it is timely to consider whether there wouldn't be some advantage in substituting a more modern type. Of course, this should not be done haphazardly, or the

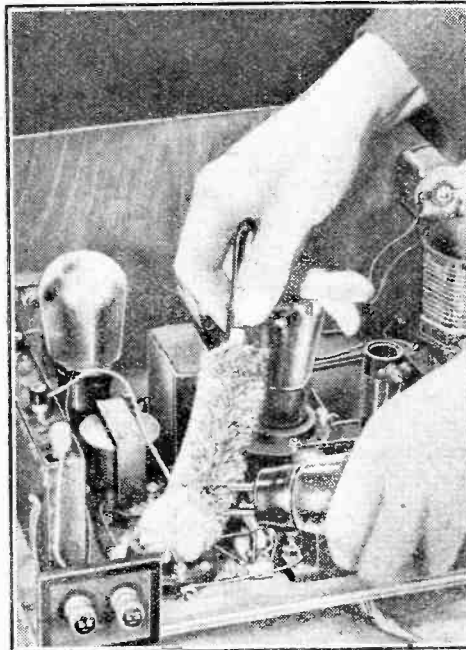

The removal of dust and dirt from the valve-holders, switch contacts and condenser vanes will often bring a noticeable improvement in performance.

last state may be worse than the first. It is not exaggerating to say that the substitution of a single valve with more modern characteristics might involve a complete redesign from start to finish. But some less far-reaching improvements can be suggested. One of the new H.F. pentodes can be substituted for a S.G. type, with little or no alteration. There are variable-mu and short-base models to replace the corresponding tetrodes. If the tuned circuits are at all good, this change should bring a useful increase in H.F. magnification. They can give much more output without overloading, too. With a big output there may be some inducement to consider a double-diode-triode, or even D.D. pentode, in place of the old detector. Detector overloading will thereby be abolished; in fact, the bigger the input the better the diode likes it. All these circuit arrangements are fully described by the makers of the valves.

The same type of detector makes it quite a light job to introduce at least a partial measure of A.V.C. The place for hand-volume control is then between the diode and the triode grid. Battery sets with old-fashioned volume controls can be modernised by fitting the new short base variable-mu valves, which at the same time give a full meed of amplification.

Iron-core Coils

If at this stage the H.F. fever becomes virulent, there will no doubt be an overwhelming desire to make the most of the new H.F. pentodes by installing a set of iron-core coils. It will be remembered that, although the magnification factor is phenomenal—as high as 5,000—the extent to which it is utilised is proportional to the goodness of the tuned circuit, and the best way of improving the latter, without at the same time risking instability due to stray coupling, is to use iron-core tuning coils which are fieldless. It is then necessary to take care of the stray capacities, covering the "live" leads with earthed screening if necessary.

Any tuned circuit improvements will be largely nullified if a bad H.F. choke is used for parallel feeding. It may be assumed that the plain single slot type is below standard for this job, and is only fit for the detector anode. The very best H.F. choke is none too good for parallel feed, because it comes right across the tuned circuit, and most chokes have nasty "hollows" at some wavelengths.

It is also very essential to make sure that ganging is up to the mark. It would be a sound plan in any case to check the ganging in any set with coupled condensers—considerably sharper tuning may be the reward. While attending to the condensers, if the scale is not already calibrated it is time to do it. Don't forget that all the station positions will soon be out of date, when the Lucerne Plan comes into force.

Decoupling

All this "hotting up" may render the model unstable. Try all you have ever learnt—screening, decoupling, one-point earthing of return leads, orientation of coils. For superhet faults refer to Mr. Cocking's recent comprehensive treatise.*

* How the Superhet Works.—Parts I-VII, *The Wireless World*, May 26th-July 7th, 1933.

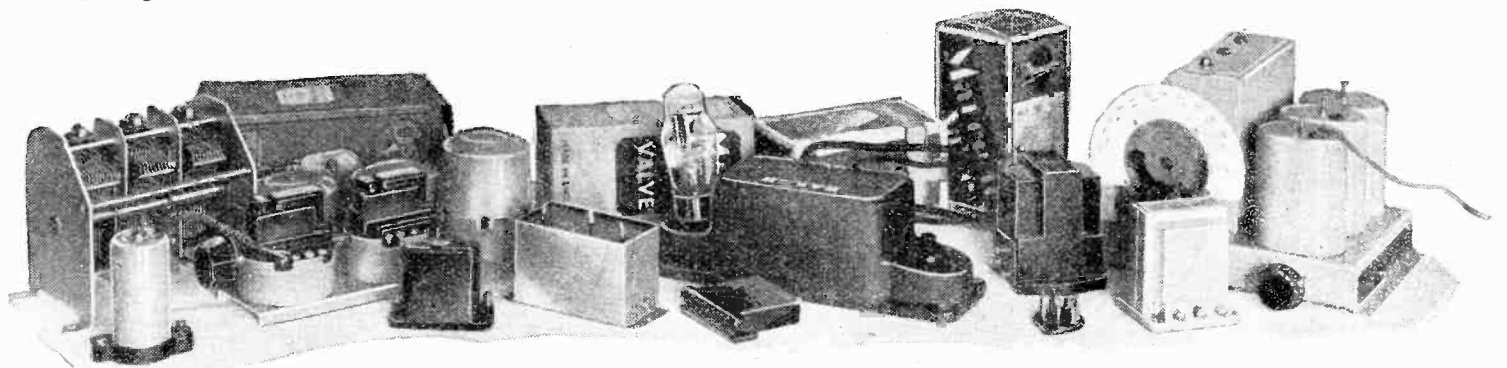

Iron-cored coils, gang condensers, new valves, a Class "B" unit and up-to-date individual components can all be used to advantage in the remodelling of an old receiver.

The Autumn Spring Clean—

Then, turning to the L.F. side, make sure that the grid bias decoupling is up to date. A 50-mfd. electrolytic condenser, as now used, is safe. The ordinary 2-mfd. cuts bass, and the decoupling filter doesn't always work—there are some curious snags in it when applied to some circuits.*

If there is a choke-coupled loud speaker output it is customary to use a blocking condenser of at least 2-mfd. Dr. Sims has pointed out some time ago† that a 0.1 mfd. sometimes gives better bass.

These bass improvements may show no hum rather badly. If so, try shifting the transformers about, or move the smoothing chokes—they often couple, with their leakage field due to the anti-saturation gap. But all hum does not come from the loud speaker. Disconnect it entirely, and then hear if the transformer or choke stampings are vibrating. If they are, a dose of varnish, soaked well in between the stampings, will silence them.

Then there is modulation hum. A pair of condensers, each of 0.01 mfd., from rectifier filament to outers of the H.T. transformer secondary, will usually stop it, but they must be at least 1,000-volt

* "Parallel Feed Precautions," *The Wireless World*, February 17th, 1933.

† "New Pentode Output Circuit," *The Wireless World*, June 29th, 1933.

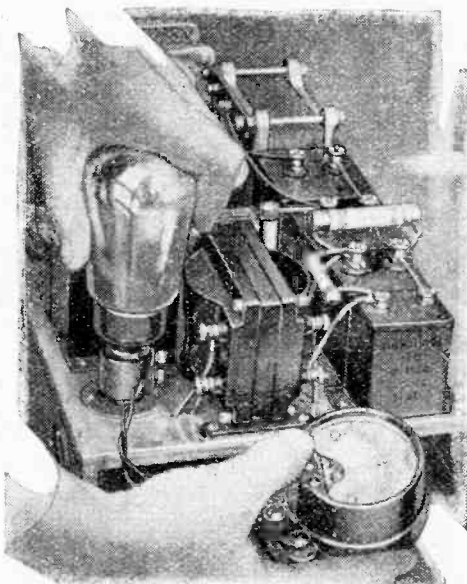

The best single test of a valve is to measure the anode current with a milliammeter.

working (for 250-0-250 transformers, or more in proportion)—the best that can be bought. Another cure for modulation hum (the sort that is heard only when a carrier is tuned) is a H.F. filter in the mains leads. A suitable choke in each lead, and a pair of condensers with the junction earthed, is the usual prescription; but what is not so generally known is that in some situations the cutting out

of interference is more complete when the condensers are on the "mains" side.

By this time we have worked our way to the loud speaker. Perhaps it can be improved by mounting it more substantially, say, in a box-baffle. Get a heterodyne note (without radiating, please!) and run right through the scale of pitch, very slowly. Do this when sensitive people have gone out for the evening. Then if there are any rattles, hold the note until you have located the cause—loose parts, dirt in the gap, etc. It is no light matter to clear the gap of a permanent magnet moving-coil speaker, so every precaution should be taken to keep it protected by a dust cover. Some manufacturers clean out the gap by forcing putty through under pressure. The best method depends on the construction, and the chances of getting the moving-coil assembly back into position after it has been removed. If the risk is taken, look for slack turns of wire on the coil, and varnish them down.

"From Aerial to Loud Speaker" includes everything unless it be a radiogramophone. Then there are the pick-up and motor. The motor may be the better for a little grease, and inspection may suggest action elsewhere, but otherwise the overhaul will be complete. And perhaps the result will beat the neighbours' 1934 model after all! Or you may decide on a new set yourself. Who knows?

IDENTIFYING VALVE BASE CONNECTIONS

THE number of valve types now available well-nigh precludes their base connections being memorised; for easy reference, therefore, twenty-two of the commoner types are listed below. It should be noted that the view is of the valve base itself and the letters D.H. and I.H. stand for directly heated and indirectly heated respectively.

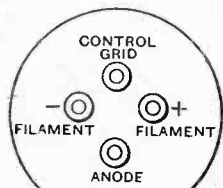

Battery and D.H. mains triode.

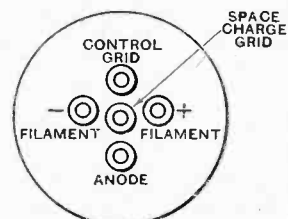

Battery and D.H. mains pentode (4-pin type, side terminal—space charge grid).

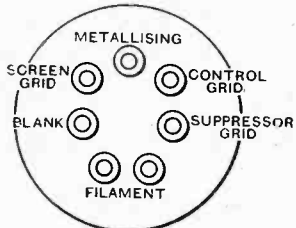

TOP CAP = ANODE
Battery screened H.F. pentode.

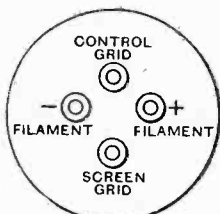

TOP CAP = ANODE
Battery S.G. valve.

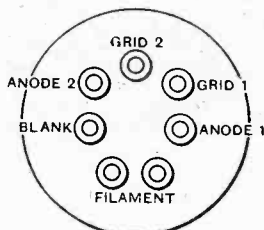

Battery Class "B" valve.

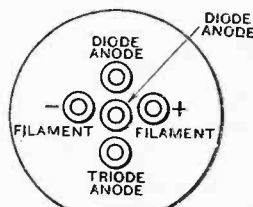

TOP CAP = TRIODE GRID
Battery duo-diode-triode.

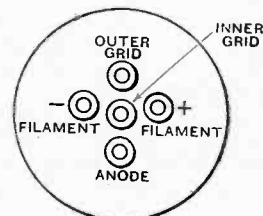

Battery bi-grid.

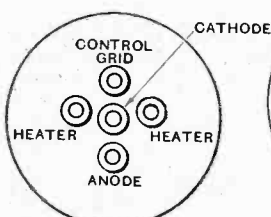

I.H. triode.

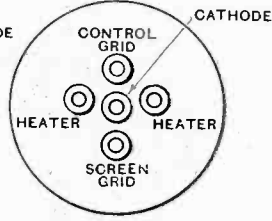

TOP CAP = ANODE
I.H. S.G. and 5-pin H.F. pentode.

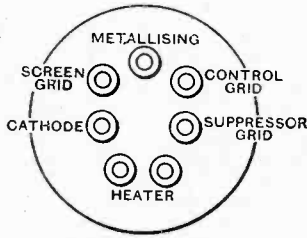

TOP CAP = ANODE
I.H. screened H.F. pentode (7-pin).

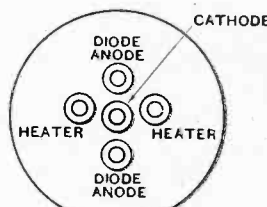

I.H. duo-diode.

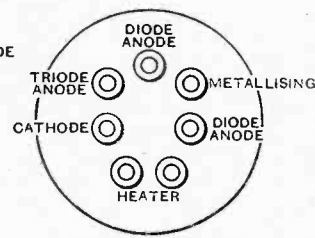

TOP CAP = TRIODE GRID
I.H. duo-diode-triode.

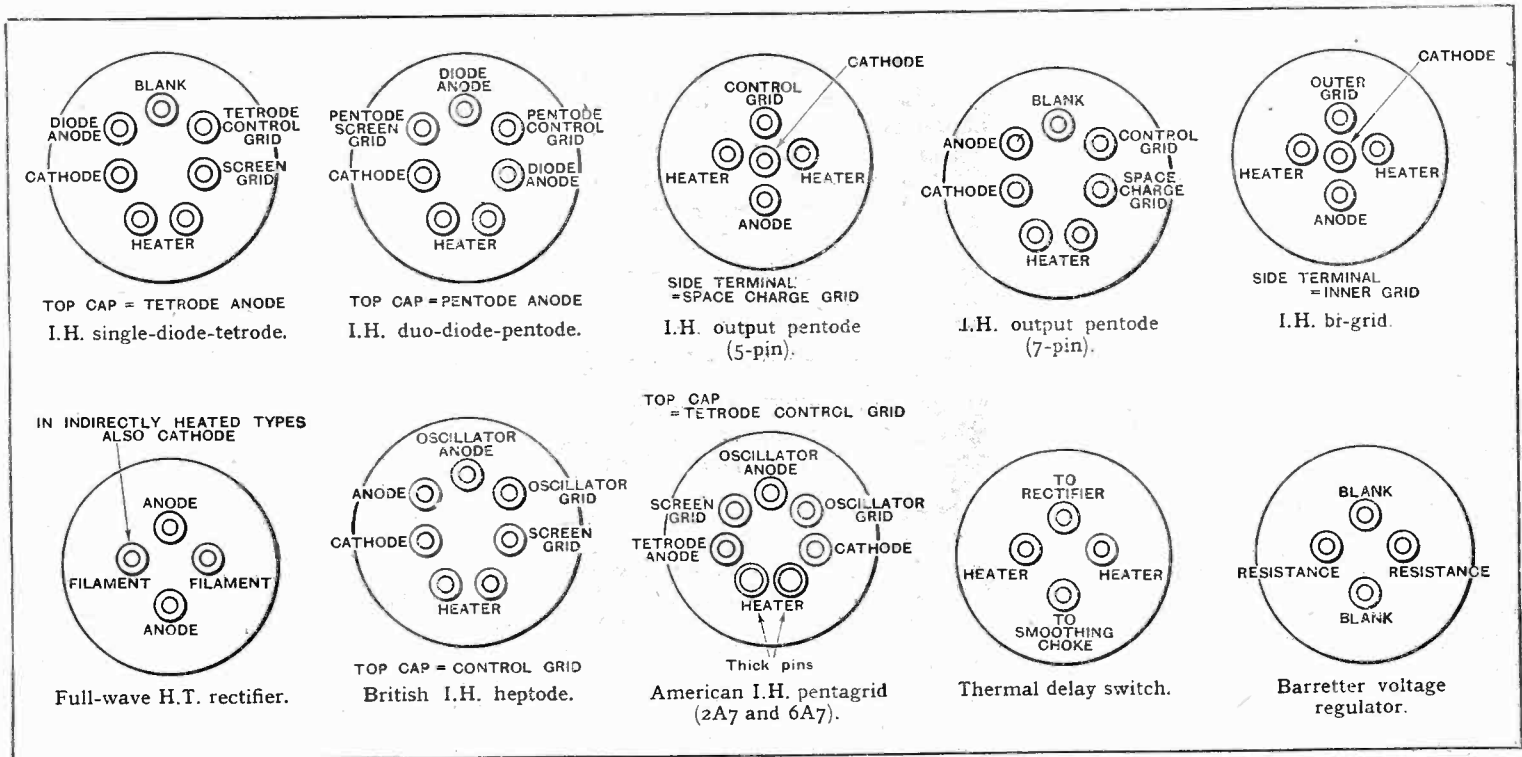

DISTANT RECEPTION NOTES

Lucerne Plan in Dispute : Transatlantic Nights

IN common with the majority of long-distance enthusiasts, I believed that the station which has for some weeks been causing serious interference with the Huizen transmission (Hilversum programme) on 1,875 metres was a Russian. Information on the subject has now been received straight from the horse's mouth in the form of a letter from the *Nederlandsche Christelike Radio-Vereeniging*. The station responsible for causing the interference, they state, is a Roumanian, which "will not be completely finished for about two years, but is now conducting experimental broadcasts." The Director of the Hilversum programmes adds that his board may find it necessary to abandon 1,875 metres and use some other long wavelength if the interference continues.

At present the Roumanian station, whose experimental transmissions take place on most evenings, is using exactly the same wavelength as Huizen, with the result that the interference forms a wobbly and very unpleasant background.

Vienna's second aerial mast, work upon which has been in progress for some weeks, should be ready for action early next month. The station will then be able to use its full power at all times and excellent reception in this country should be assured.

Amsterdam Hopes

The meeting of the U.I.R., which opens at Amsterdam early in October, has been convened for the purpose of bringing the eight countries which did not sign the Lucerne agreement into the fold if possible. Whilst one earnestly hopes that the effort may be successful, the prospects of obtaining all of the desired signatures do not seem very bright at the moment.

Not a few people have asked me whether it is really important that the Lucerne Plan should come into operation. "Why not

leave things as they are?" they ask. "We are doing very well at present with thirty or forty stations available on most nights." The crux of the matter is that we have to look to the future. There are more than a dozen new stations—many of them of high power—to come into action within the next few months, and only by the adoption of



THE ETHER POLICEMAN. An informal picture of M. Raymond Braillard, the popular chief of the International Broadcasting Union's wavelength control post at Brussels.

the Lucerne Plan, which was drawn up with an eye to the future as well as to the present, can chaos be avoided on both the medium and the long wavebands.

Hamburg's new 100-kilowatt transmitter is nearing completion, and experimental broadcasts are likely to be heard shortly outside ordinary programme hours.

The upward movement of the optimum wavelengths for transatlantic reception continues, as I suggested some time ago that it might. A station that I heard only once or twice last winter, W.G.Y. on 379 metres, and then at poorish strength, is now

well received in the small hours on favourable nights. It will not be long, I believe, before we are regularly hearing W.J.Z., W.L.W., and others of the big U.S.A. stations with wavelengths above 350 metres.

The best long-wave stations at present are Radio-Paris, Zeesen, Luxemburg, and Kalundborg. Motala and Oslo, though usually strong, are both liable to suffer from heterodyne interference. Interference has also been noticeable with Athlone's transmissions. It is definitely not caused by any of the authorised stations working on wavelengths in that neighbourhood; it must therefore be due to one of the "illicit" transmitters, of which far too many are still at work. Of the medium wave stations, the best at the moment are: Langenberg, Hilversum, Prague, Rome, Brussels No. 1, Leipzig, Toulouse Midi, Breslau, Heilsberg, Nuremberg, and Milan. Bordeaux Lafayette, Munich, Genoa, and Florence are all worth attention.

D. EXER.

FOREIGN BROADCAST GUIDE

RADIO AGEN

(France).

Geographical position: 44° 15' N.; 0° 37' E.

Approximate air line from London: 500 miles.

Wavelength: 453.2 m. Frequency: 662 kc/s. Power: 0.25 kW.

Standard time: Greenwich Mean Time.

Standard Daily Transmissions

12.30 G.M.T., Concert, news, talks; 20.00, concert 21.15, sporting news, etc.

Announcer: Man.

Call: *Ici poste départementale de Radio Agen en Lot et Garonne* (between items, *Ici Radio Agen*).

Closes down with usual French good-night greetings: *Bonsoir Mesdames, Bonsoir Mesdemoiselles, Bonsoir Messieurs*, followed by *La Marseillaise*.

UNBIASED

By
FREE GRID

Publicity Pests

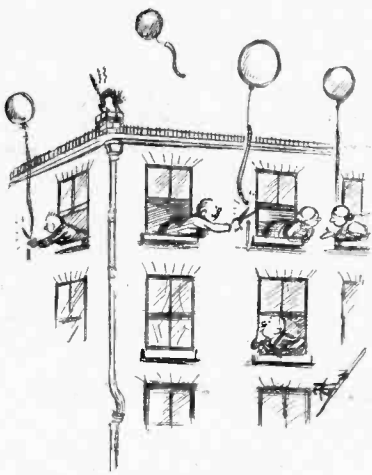

Getting rid of the nightmare.

Sabotage in Salford

WHILE at the feeding troughs one day during my visit to the Manchester exhibition, I was chatting with a friend on the subject of screened down-leads. I was remarking that such things were of very little use to anyone who lived in a flat, when an obvious Mancunian who was sitting on the other side of me suddenly butted into the conversation with a strong denial of my assertion, and proceeded to explain that actually they were of more use to flat dwellers than anyone else. As proof, he cited his own particular circumstances.

It appeared that he lived about half-way up a tall tenement, and, but for a flash of genius for which Northerners are justly famous, would have had to be content with an indoor aerial. He had, he explained, obtained a small captive balloon for a mere song from a dealer in Government surplus stores and had at first used it to suspend a vertical aerial a few feet above the room. Unfortunately, however, as the down-lead came down alongside the wall to his window he lost most of the energy which was picked up aloft.

The aforementioned flash of genius had, however, inspired him to use a screened down-lead, with the result that, so far as wireless reception was concerned, he soon became the envy of the whole street. He was not long, however, without imitators, with the result that the whole roof area of the place was now literally bespangled with captive balloons, and open warfare had broken out among neighbours, who secretly cut each other's balloons adrift at night in order to get rid of the nightmare of mutual interference with tuning, which was so rampant.

B.B.C. Please Note

I'VE never made any bones about revealing my opinion that the future of television lies in an electrical rather than in any mechanical system. It was, therefore, in a somewhat carping frame of mind that I recently accepted the invitation of a noted "televisionary" to come and have a look-in on the latest outfit.

The instrument was not home-made, as

I had anticipated, but was one of the latest type of mechanical radiosopes loaned to my friend on the assumption that his opinion on it was valued by the manufacturers.

We sat down in front of the instrument, and at a couple of minutes to eleven my friend stirred it into action in order to give the motor time to reach the speed at which the synchronising signal, when it came along, could hold it in step.

Eleven p.m. came and went, but still no synchronising signal, and my friend was soon perspiring freely, owing to the amount of juggling with the regulator control which was necessary to hold it at the correct speed until the start of the programme. At his invitation I took over the controls, but soon repented my hasty action, and began inwardly to curse the B.B.C. and all its works.

After a considerable delay the voice of the announcer blandly told us that it was six minutes past eleven, as if we didn't know it already, and then went on to intimate that, if we were good children, we should have a television demonstration *after a wretched reading had been waded through*. When it finally did come, the demonstration was much better than I had expected; indeed, I will even say that it was distinctly good, although it goes against the grain for me to have to admit it.

My enjoyment of the demonstration was completely spoilt, however, by my efforts to bottle up my wrath at the cavalier manner in which we television people are treated by the B.B.C. It isn't like an ordinary broadcast set where you can just switch on and wait, as it takes all the stuffing out of you to keep on juggling with the wretched thing until the synchronising signal comes on to take charge, as I know



Stirred it into action.

to my cost. In my opinion the B.B.C. should observe the same punctuality in regard to these matters as obtain at an execution.

A NEW menace threatens the sanctity of our homes. The other evening I was comfortably ensconced before the fire complete with pipe, carpet slippers, dressing-gown and loud speaker; Clapham and Dwyer had just got into their stride when the telephone bell rang, and as nobody else was at home I had to shuffle out of the room and answer it myself, feeling exceedingly annoyed at being interrupted at such an inopportune moment. Placing the receiver to my ear I was amazed to hear the voices of Clapham and Dwyer coming through, and I wondered if the rumour that the P.M.G. was to supply broadcast programmes to all telephone subscribers was true after all.



Had to answer it myself.

After a few moments the item abruptly ceased, and a distinctly non-B.B.C. voice informed me that I had been listening to an extract from a broadcast programme relayed from the showrooms of Messrs. Blank and Co., a departmental firm who had recently opened up in the locality; after further enjoining upon me the necessity of visiting their showrooms to buy a set, the caller rang off. I endeavoured to ring up the firm, but was told that the number was engaged; and subsequent attempts to get through to them later in the evening proved equally fruitless.

A personal call on the manager of the radio department the following day revealed why I could not get through. All the dozen telephone lines of the firm had been engaged throughout the evening in this publicity stunt.

The manager explained that only those items which were of a cheerful nature and at the same time were suited to the limited frequency characteristics of the P.O. telephone lines were relayed. Further conversation elicited the fact that it was becoming quite common for gramophones to ring up their dealer for a telephone demonstration of a new record, and it was this practice which had given him his idea. If this sort of thing spreads, I suppose that when television is perfected we shall all face the alarming prospect of being rung up and having a mannequin parade forcibly thrust before our eyes.

In Next Week's Issue

"The Wireless World"

A.V.C. Three

An Easily Assembled
"Straight" Set Incorporating the Very Latest Design of Automatic Volume Control

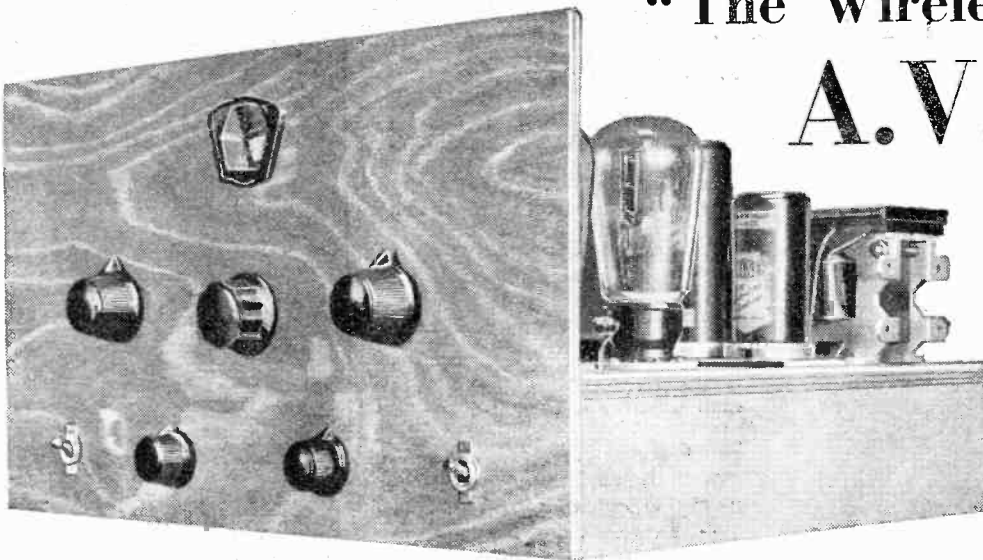

AUTOMATIC volume control has hitherto been confined to the larger and more expensive class of receiver, and has found its chief application in the superheterodyne. One of the main difficulties in the way of fitting A.V.C. to a small, straight set has lain in obtaining simultaneously good A.V.C. action and reaction. These difficulties have now been overcome, and with the aid of the duo-diode-triode valve it is possible for the first time to construct a three-valve set which includes not only normally operating reaction but also delayed amplified automatic volume control. The new receiver has a variable-mu screened H.F. pentode as the H.F. am-

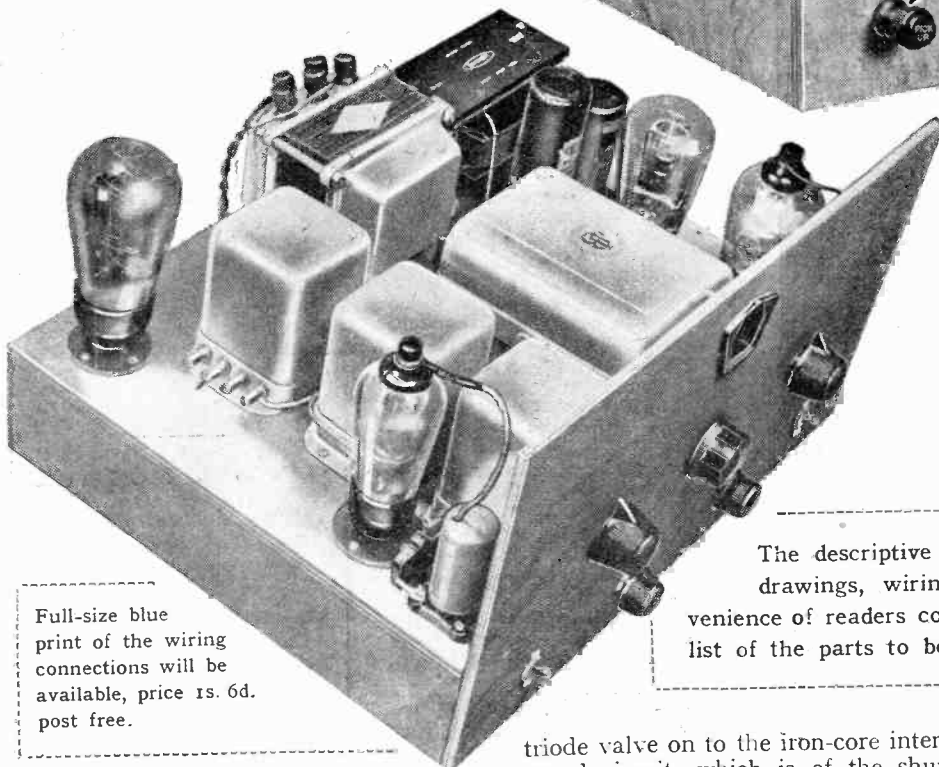
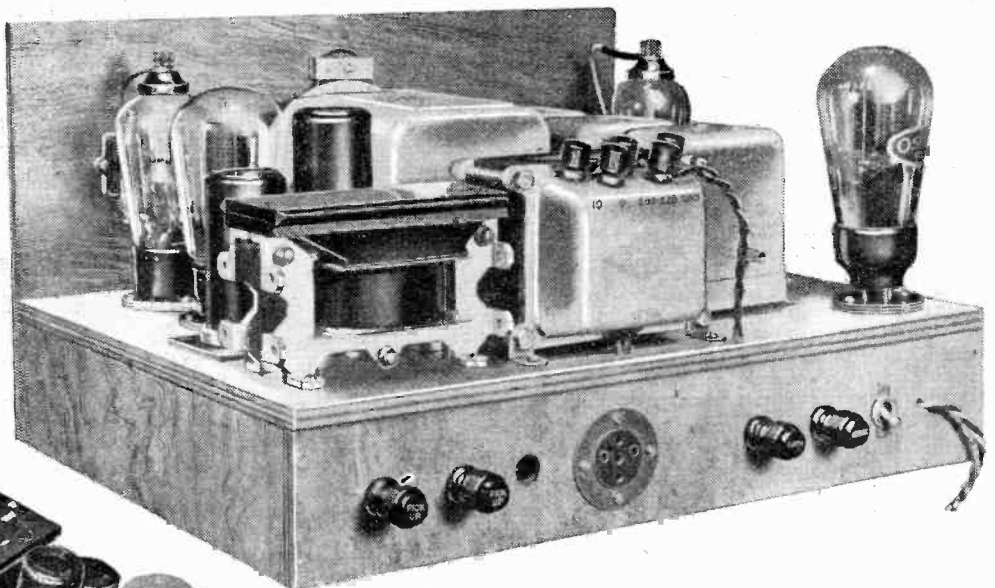

Full-size blue print of the wiring connections will be available, price 1s. 6d. post free.

plifier, and it is preceded by a band-pass filter employing iron-core tuning coils. Reaction is obtained from the duo-diode-

triode valve on to the iron-core intervalve tuned circuit, which is of the shunt-fed transformer type, and this stage is coupled to the output pentode by means of a tone-correction L.F. transformer

which enables any distortion introduced by reaction to be counteracted.

The output obtainable is 2,500 milliwatts, and the manual volume control is operative on both radio and gramophone. The smoothing equipment includes high-capacity electrolytic condensers in order to ensure hum-free operation from A.C. lighting mains.

The quality of reproduction reaches a high standard, and the volume obtainable is adequate for all normal requirements.

The descriptive article will be fully illustrated with circuits, drawings, wiring diagram and photographs. For the convenience of readers contemplating the building of this receiver a full list of the parts to be used will be found on page 294 of this issue.

The sensitivity and selectivity are sufficiently high to permit reception at entertainment value of the principal Continental stations, even at short distances from high-power local transmitters.

NEWS of the WEEK

Current Events in Brief Review

150 Kilowatts from Oslo

THE Oslo Broadcasting Station will shortly double the existing aerial power of 75 kilowatts in time for the inauguration of the Lucerne Plan in January next.

Incitement to Murder?

WHEN the Swanscombe Urban District Council was approached in regard to the noise from wireless sets in council houses, the clerk stated that this was a matter for the tenants themselves to take action.

Bremen To-morrow

TO-MORROW sees the opening of the new Bremen relay station on a power of 1.5 kilowatts, i.e., about six times the power of the existing transmitter. Bremen will work on a common wavelength of 227.4 metres with Flensburg and Hanover.

Algiers on High Power

RADIO ALGIERS should obtain fresh fame next spring when its power is increased to 75 kilowatts. The local enthusiasts welcome the Lucerne Plan, which enacts that their station shall work on 318 metres and thus avoid the interference of Stuttgart and Barcelona. Only one thing remains to contribute to the general satisfaction, and that is the voting of the necessary credits by the French Government.

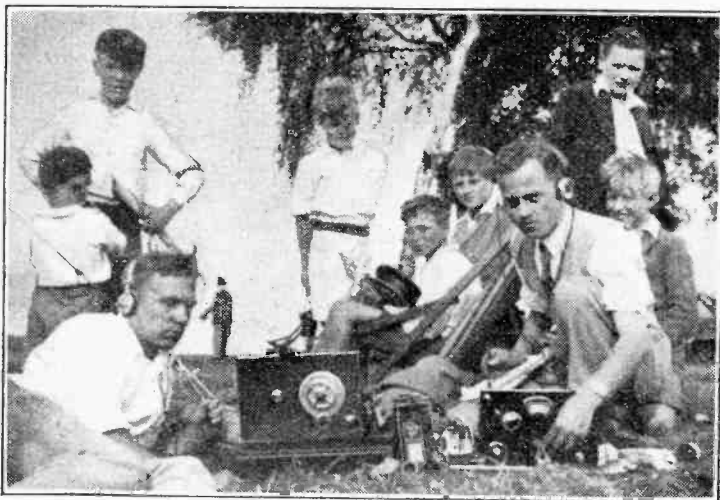

KITE-FLYING WITH SHORT WAVES. Members of the International Short-wave Club on a recent successful Field Day at Parliament Hill. An effective aerial was suspended from a kite. Kite cord and aerial can both be seen in this picture.

No Fairy Tales

THE Brazilian Government has forbidden broadcasting stations to transmit fairy tales for the children after dark, it being considered that stories of this kind may be over-stimulating to the youthful imagination.

A correspondent points out that it would be a good thing if the European stations were forbidden to broadcast the fairy tales which are normally intended for adult consumption throughout the evening.

Strasbourg, Too

YET another station is to increase its power, namely, Strasbourg, which it is claimed must work on a considerably higher output if it is to maintain its prestige.

Camping Habit Spreads

GERMANY'S concentration G camps are steadily filling up with persons who listen-in to broadcasts from Moscow. Moscow has lately been broadcasting a special Communist news service for Nazi Germany.

The strict censorship of news in the German press has increased the habit of tuning-in foreign news bulletins, but it would appear that in Germany to-day there are distinct dangers in reproducing anything Russian on the loud speaker.

Radio-controlled Train

A "DUMMY" train operated by radio with the object of hoodwinking bandits is to be tested by the Japanese army in Manchukuo. It is planned to run the empty train at a distance of a quarter of a mile ahead of one fully manned by armed troops. It is expected that the bandits will fall upon the decoy train, to be fallen upon in turn by the Japanese troops. The idea should work, unless this copy of *The Wireless World* should reach the bandits before the experiment is tried.

New Moscow Radio House

A COMPETITION has been organised for the best architectural designs for a new Radio House for Moscow. Eight prizes of 30,000 roubles each are offered.

Helpful

"CAN you tell me what I can do to cut out interference from foreigners?"—Querist in a daily paper.

Answer: "The surest method is the purchase of another and more selective receiver."

German Television Developments

TELEVISION at the 1933 Berlin Radio Exhibition is the title of a lecture to be given by Mr. Ernest H. Traub, at a meeting of the Television Society at University College, Gower Street, London, W.C.1, on Wednesday next, October 11th, at 7 p.m.

Cards of invitation for non-members of the society may be had on written application to Mr. J. J. Denton, 25, Lisburne Road, Hampstead, N.W.3.

Lectures on Television

A COURSE of lectures on television has been started at the Borough Polytechnic, Borough Road, London, S.E.1, under the direction of Mr. J. J. Denton, A.M.I.E.E., hon. secretary of the Television Society. Lectures, which are illustrated by experiments and demonstrations, are given weekly on Thursdays from 8-9.30 p.m.

Full particulars of the course may be obtained on application to the principal of the Polytechnic.

America's Radio Centre

LESS than two weeks after American broadcasting celebrates its thirteenth birthday on November 2nd, the National Broadcasting Company will inaugurate its elaborate new quarters in Rockefeller Centre, which will include what are claimed to be the largest and most completely equipped broadcasting studios in the world.

The formal opening date will be Tuesday, November 14th, when sixteen of the thirty-five studios will be employed in a great gala programme. One of the studios, which is called the Auditorium Studio, will be the largest in the world, measuring 78ft. x 132ft., and being three storeys in height.

It is understood that Sir John Reith, Director-General of the B.B.C., will be among those present at the opening ceremony.

Anti-fading Aerials

VERY tall single masts are to be a characteristic of all German broadcasting stations in the near future, following upon the decision to use anti-fading aerials similar to that successfully tested at Breslau. Even Muhlacker,



THE COMPLETE "ULTRA-SHORT"—IST. Mr. A. E. Shaw ("Tuner" of the *Yorkshire Observer*) with his portable 5-metre receiving outfit on a Field Day.

Munich, and Leipzig, at present working with ordinary "T" aerials, will scrap their twin wooden masts and erect the single lattice tower necessary with the new ring-shaped antenna.

It is claimed that these aerials increase the local service area by from 20 to 25 per cent., but it is emphasised that the distant reception possibilities are not affected.

Edinburgh's Radio Show

WAVERLEY Market, Edinburgh, will be the scene of the Fourth Annual Scottish Radio Exhibition, opening on October 11th. It is claimed that the exhibition is international in scope, as American and Continental sets will be on view. The B.B.C. is supporting the exhibition by installing a model studio, through the glass panels of which visitors to the exhibition will be able to watch a normal programme in course of presentation before the microphone.

The G.P.O. will also be represented with a replica of the Post Office exhibit at Olympia, London, dealing with the cause and prevention of electrical interference.

The exhibition will remain open from 2 to 10 p.m. each day until Saturday, October 21st.

THE WIRELESS ENGINEER

Special Articles in the October issue:
NEW TYPES OF TRANSMITTING AERIALS

APPLICATIONS OF THE DYNATRON

Characteristics and operating conditions of the screen-grid valve used as a Dynatron.

S.G. VALVE AS SUPERHET DETECTOR

OLYMPIA 1933

A review of exhibits of special technical interest at the recent Show.

MEASURING RESISTANCES

The issue also contains monthly abstracts of the world's wireless literature and abstracts of recent patents.

Copies are now on sale, price 2/6, or post free from the publishers, 2/8.

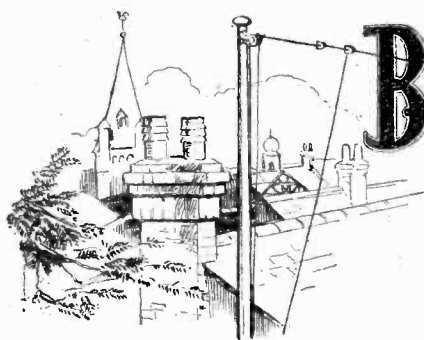

Broadcast Brevities

By Our Special
Correspondent



The *Kinematograph Weekly* remarks that these developments are "of immediate interest to exhibitors and technicians."

I should just think so!



This Television

THOSE who are looking for excitement should enter the television arena. Everything seems propitious for a battle royal between the rival systems.

Last week, when the "news" was published of the termination on March 31st, 1934, of the Baird agreement with the B.B.C. in connection with the 30-line transmissions, things looked black for the Baird firm. Nothing has been published, however, which indicates any obstacle to the renewal of the contract.

Things Are Not What They Seem

I will venture to state that prospects were never brighter for the Baird interests, as, indeed, for any British television system, than at the present time.

The B.B.C. has no intention of discontinuing television experiments, and any suggestion that owners of television receivers may find themselves with no transmissions to tune in can be dismissed as untrue.

A Chat with Captain West

Captain A. G. D. West, formerly of the B.B.C. and H.M.V., and now in sole charge of the technical development of the Baird system, was full of enthusiasm when I chatted with him last week on the Crystal Palace television tests which are now beginning, and to which I was able to make first exclusive reference in *The Wireless World* of July 7th last.

All About the Crystal Palace Tests

The transmitter, which employs 500 watts, is housed at the base of the North Tower, with a feeder line to the aerial. Very soon a much more efficient transmitter will operate from the South Tower, though the sound programmes may continue from the North Tower on the temporarily allotted wavelength of 155 metres. Later on the sound will be transmitted on between 6 and 6.25 metres, which is the ultra-short wave-band specially allocated for the tests.

For one week the 30-line television will go out on 6.25 metres; then, for a week, 60-line images will be transmitted, followed by a week on 120-lines.

180-Line Pictures Soon

Within two months from now the company hopes to be covering all London and, indeed, a radius of thirty to forty miles from the Crystal Palace, with 180-line television, using the latest Baird transmitter, similar to that now installed on the roof of Broadcasting House. In the early stages films will be used, but later on real flesh and blood entertainment will be provided.

Anxiety in the Cinema Trade

By the way, the cinema trade is displaying a lively interest in J. L. Baird's present experiments in large-screen projection. Already 90-line pictures have been very satisfactorily projected upon a screen 8ft. by 6ft.

The New Anti-pirate Van

I MAY be wrong, but it seems to me that whenever the Postmaster-General experiments with a new pirate-catching van, he chooses the Newcastle and Sunderland area in which to put it through its paces. Perhaps Newcastle likes this sort of thing.

Why not give Kensington or Wimbledon a chance?



The Northern Ireland High-power Station

A SITE near Lisburn, close to a large cemetery, has, I understand, been decided upon for the B.B.C.'s new high-power transmitter for Northern Ireland.

Negotiations are practically complete, and designs for the station buildings are now in preparation. The work of construction should begin very shortly.



Mr. Arthur Burrows: A False Rumour

MR. ARTHUR BURROWS ("Uncle Arthur" of the old British Broadcasting Company days) is issuing a personal denial of the story that he intends returning to England to join the Corporation staff.

This will be disappointing news to the older generation of listeners, who will never

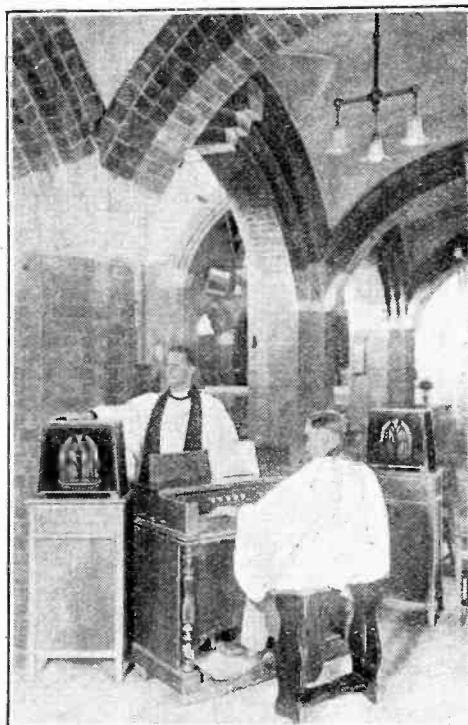

PIPE ORGANS SUPERSEDED? Here is an idea for the B.B.C. furnished by the Vicar of St. Margaret's, Coventry. When the church organ broke down he coupled a microphone and five-valve amplifier to two moving-coil speakers. An old harmonium supplies enough volume to fill the building.

forget the pioneers who first put broadcasting on its feet and gave to the early programmes a homely and friendly atmosphere which has been lost for ever.

The hard-worked Secretary of the Union Internationale de Radiodiffusion will always be assured of a warm welcome over here.



"Am Freiceadan Dubh"

THE "Black Watch" ("Am Freiceadan Dubh"), a play for the anniversary of the regiment, by John Gough, will be relayed from Edinburgh to National listeners on October 24th. This is a chronicle play covering incidents in the history of the regiment between 1740 and 1917.



Six Telephone Talks

CECIL LEWIS'S "Pursuit," a play in the Radio Drama Festival now in progress, is to be broadcast on October 16th (Regional) and 17th (National). There are no stage directions or word pictures in this play. It starts with six telephone conversations (the equivalent of screen "close-ups"), the intention being to enable listeners to familiarise themselves with the principal characters.

The Radio Drama Festival will continue on October 27th (National) with Lance Sieveking's "Kaleidoscope," which was first heard by listeners in the early years of broadcasting.



A Friend Abroad

TO tell us what an Englishman thinks of America when on his first visit to "God's Own Country" is the purpose of Mr. S. P. B. Mais's series of talks, "The Modern Columbus," which are to be relayed across the Atlantic on Friday nights at 9.30, beginning on October 13th.

On that night, Mr. Mais's lone voice will be heard in Lexington, Virginia. A week later he will give us his impressions of Jacksonville and Miami, Florida. New Orleans will be visited on October 27th, and our pioneer's subsequent messages will hurtle across from Texas, Arizona, California, Washington, Minnesota, Illinois, Pennsylvania, Massachusetts, and New York.

I shall listen earnestly to discover whether, as the weeks pass by, Mr. Mais's eminently English accent can stand the strain.



Misunderstood

A ROMAN Catholic missionary tells of an amusing experience the other day when he was touring a new housing estate in the Birmingham area.

At a certain house he put the usual question: "Excuse me, are you R.C. here?" and got the reply: "No, we're A.C., and if it's wireless you're selling, we've got one."

Television

Progress

The Present Stage of Development

THE time has come when it is opportune to take stock of the present position in television, and in this article we endeavour to present our readers with a picture in proper perspective of the present state of development, with a discussion on limitations of existing systems and the possibilities which lie ahead as a result of recent laboratory progress.

THE art of television is one of many examples in which invention has outstripped achievement. A glance through the literature of the subject is sufficient to show that practically all of the basic methods of transmitting optical images by electrical means are old in conception, though it is only in recent years that success of a practical kind has been attained. The situation in this respect is somewhat analogous to that of radiotelephony, the advent of which was delayed until the means of

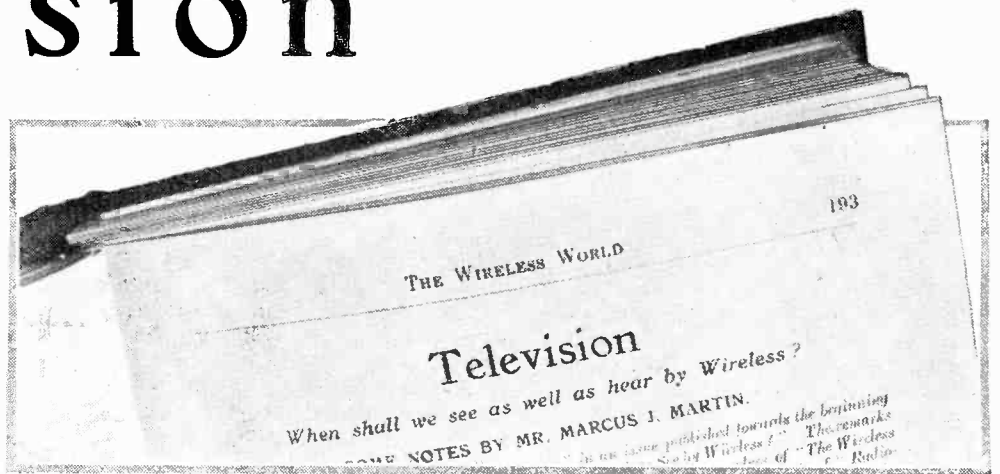

How long ago "The Wireless World" began to take an interest in the possibilities of television is indicated by this reproduction of the heading of an article which appeared in an issue dated June, 1915.

obtaining practical results became available in the shape of the thermionic valve, but the technical difficulties in the case of television are so much greater that the solution of the problem, in terms of communication or entertainment value, is even now barely being approached.

In one sense the present situation is highly favourable to the development of television in a practical form. The public are accustomed to a broadcasting service and are looking forward, perhaps with greater certainty than is justified, to an early date when sight of the same degree of perfection as sound will form a normal part of broadcast transmissions. The enterprise and energy of the Baird Company has led to a service of broadcast television which, at any rate, has whetted the appetites of those who have

received the transmissions, and has proved once more how adaptable are the human faculties to relatively imperfect presentations of the original subject matter. The B.B.C. are also fully alive to the possibilities of television, and the skill with which they have made the most of the limitations of the medium in the present transmissions has completely justified the inauguration of a regular service of the present character.

Having regard to the future of television, we may thus say that there is at the present moment an attitude of expectancy on the part of the public, who consider that the solution is merely a matter of time, and, while this is in itself a stimulus to invention and commercial enterprise, it may also constitute a danger in the measure in which the existing optimism is not warranted by the facts. It is not sufficient to say that high quality television is bound to come, and that it is only a matter of logical development before the television screen becomes as common an object in the home as is the loud speaker at the present date. We must examine the technical justification for such a proposition and face the basic difficulties inherent in the problem, and then, and then only, will we be able to form an estimate as to how much we may reasonably expect.

How Sight Differs from Sound Broadcasting

It is perhaps opportune at this juncture to consider the essential difference between the broadcasting of sight and sound, namely, the fact that a visible subject has to be analysed into elements which are successively transmitted as modulations of the carrier wave, and, after reception, synthesised so as to give back again a representation of the original. It is unnecessary to labour this point, which is probably familiar to all readers of *The Wireless World*. A satisfactory analogy is that of a page of a book, which can either be regarded as a visible object, i.e., synthetically, or as a succession of letters,

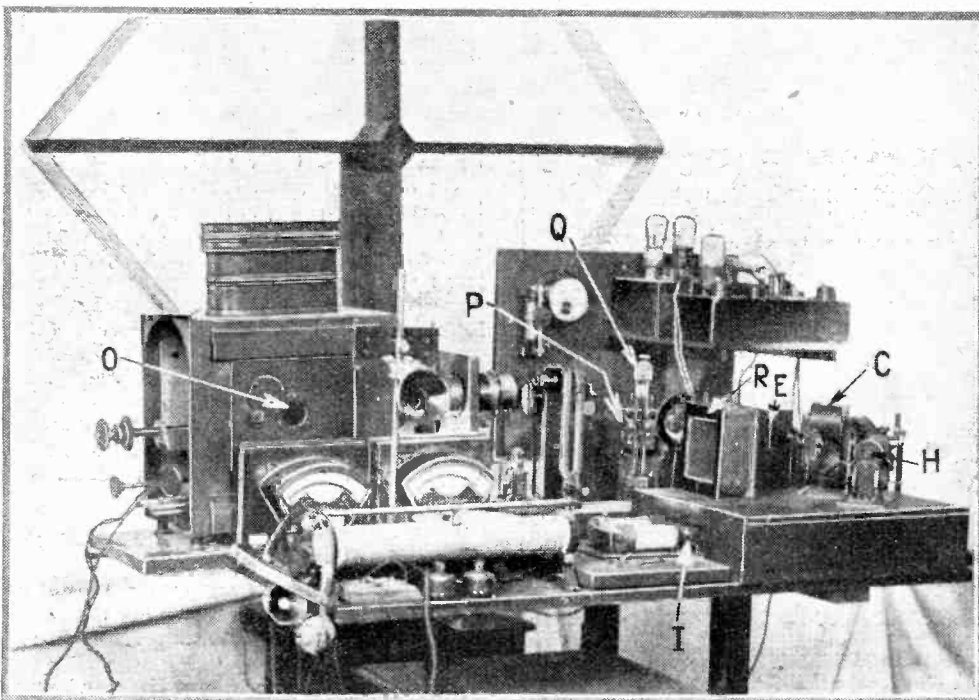

An early worker in the field of television was a young Hungarian engineer, Mihaly, a description of whose first practical efforts was included in "The Wireless World" of March 26th, 1924. This photograph appeared in that issue to illustrate some of his apparatus.

Television Progress—

is, however, one important aspect and that is the degree of subdivision of the object, i.e., the number of so-called "picture points."

If we take a concrete example in which scanning is, say, from left to right, we regard the picture as being made up of a succession of horizontal lines the thickness of which is just sufficient to fill the whole

to walk before one can run, have been amply justified. In the writer's view, however, in spite of the good results which have been obtained *within the limitations of the system*, the time has come when an increase must be made both in the number of picture points and in the rate of repetition of the picture. We thus arrive at the fundamental difficulty of organising a television service; no

detail have been explored. Any future system may then comprise scanning apparatus giving a finer analysis of the picture and a radio link on a short wavelength where the required side-band width is alone available.

[In a further article the laboratory progress with other systems will be discussed in particular reference to short-wave transmission.]

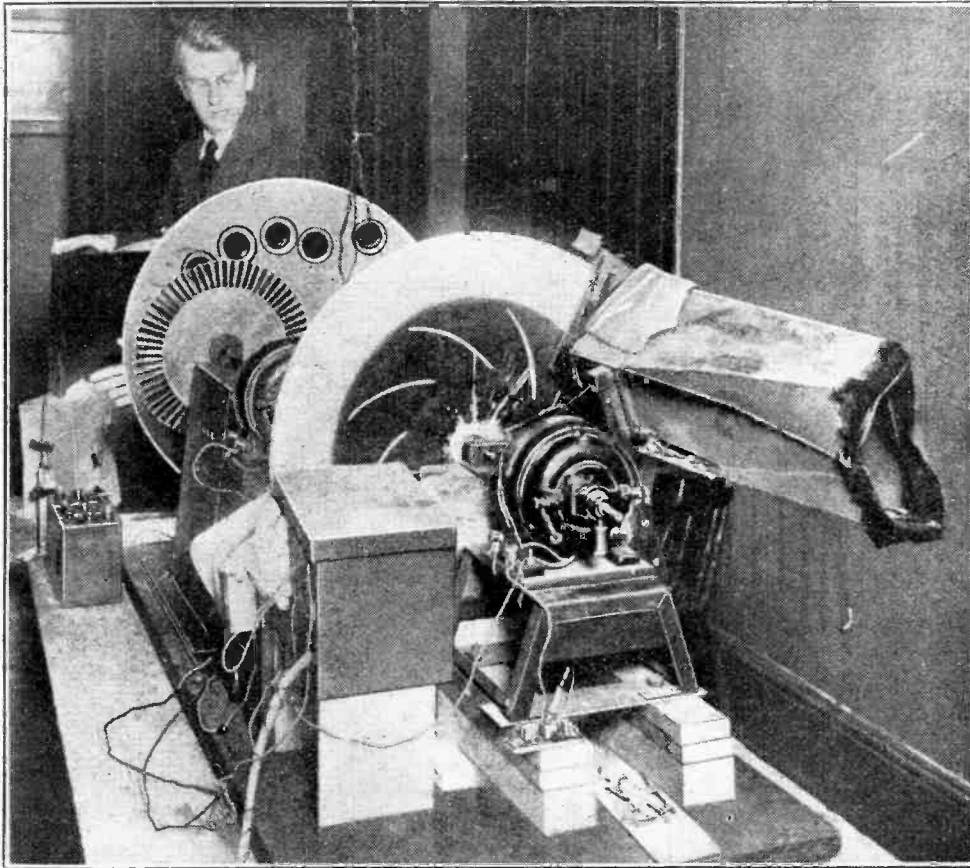

A photograph of Mr. Baird with an experimental television equipment set up in his laboratory in the summer of 1925.

of the area which is being scanned. If the latter be taken as rectangular, the thickness of the lines will be equal to the height of the picture divided by the number of lines, and if we wish the detail of the picture in a horizontal direction to be of the same degree of perfection as that in a vertical direction we may imagine each line to be divided up into squares the sides of which are equal to the thickness of the lines. It is then just possible to transmit a pattern consisting of alternate black and white squares each of which is of the size of one "picture point," but no finer grained picture can be transmitted or reproduced.

The problem of television thus consists in settling, in the first place, what rate of repetition and degree of detail will give rise to a satisfactory picture, and, secondly, in devising apparatus for analysing and synthesising the image of the visible object which is being transmitted and received.

With regard to the first point, there is no doubt that the present Baird transmissions have provided an excellent starting point and, on the basis that one must learn

really basic improvement is possible unless the system of transmission is changed, all existing television receivers thus becoming obsolete.

Wavelength and Present Systems

However, there is one circumstance which is favourable to the present situation, and that is the fact that no material improvement to the existing television service is worth while if the medium wave broadcasting band is to be used for the radio link. With the present system of transmission it would be desirable to transmit modulation frequencies as high as 20 or 30 kc/s, but, as is well known, a greater side-band width than 9,000 kc/s on either side of the carrier is not possible in view of the congestion of the ether. It is therefore out of the question to increase the picture points unless a change of wavelength is made of such a character that the necessary side-band width can be accommodated, and there is no reason why the present system should not remain as a standard, at any rate until the possibilities of television in finer

The Micromesh Tunograph

THE advent of automatic volume control has led to the development of visual tuning indicators as a means of determining when exact resonance with a station has been obtained, for the action of A.V.C. is such that the ear cannot always be relied upon to select the optimum tuning position. Such indicators may take many forms, but the Micromesh Tunograph is particularly interesting in that it functions on the cathode ray principle—it is, in fact, a miniature cathode ray oscillograph. The tube fits a standard five-pin valve-holder, and its filament is rated to consume 0.85-1.0 ampere at 0.5-0.6 volts; in practice, however, it may be operated from the standard 4 volts A.C. line by connecting a 4 ohms resistance in the filament circuit.

The anode requires a minimum operating potential of 180 volts, which may be conveniently derived from the H.T. supply to the receiver. Two alternative methods of connection are suggested by the makers—in one a resistance is inserted in the H.T. feed to the H.F. or I.F. valve, and the change in potential across this with increasing grid bias is used to operate the Tunograph. With the alternative connections the indicator is fed with the H.F. or I.F. signal potentials, and these cause the cathode ray to vibrate rapidly in a straight line, the length of which is dependent upon the signal strength. This particular connection is probably the more interesting, and tuning is carried out for maximum length of a line of light on the plate into the tube, which must, of course, be fitted in a readily visible position.

The system is of particular interest in that it involves no moving parts, the indication being entirely by the deflection of a beam of electrons impinging upon a special plate which is capable of translating the deflections of the beam into a visible effect.

The Tunograph is manufactured by Standard Telephones and Cables, Ltd., Connaught House, Aldwych, London, W.C.2, and the price is 17s. 6d.

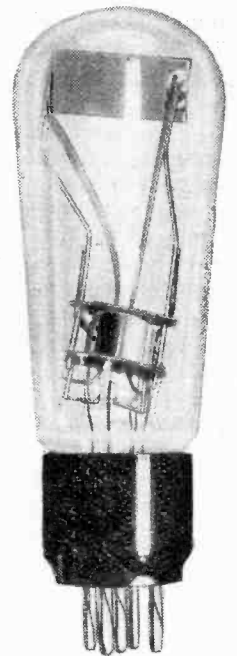

McMichael Twin Supervox

A Table Model Receiver with Dual Loud Speakers

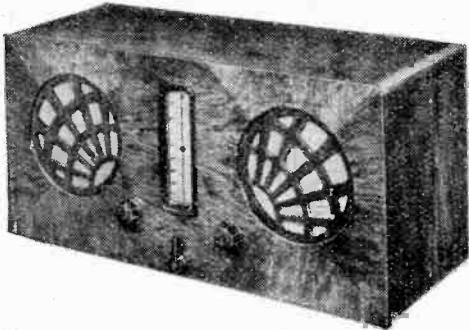

high-note response is definitely above the average. It is balanced by an adequate medium and low-note response, and, due to the paralleling of the speech coils, this is obtained without any appreciable resonance.

and the turns are spaced. Waverange switching is accomplished by switch units mounted adjacent to each coil and operated by a link motion from the control knob.

All the components are well spaced in the metal chassis, which, with the twin loud speakers, forms a single unit which is easily withdrawn from the cabinet. An interesting feature is the arrangement of the mains voltage adjustment, which is mounted underneath the cabinet and is protected by a metal cover plate.

The valves in the circuit are all of the metal "Catkin" type, and the power rectifier is of the voltage-doubler metal

FEATURES

Type:—Four stage open aerial "straight" set for A.C. mains. Twin moving-coil loud speakers.

Circuit:—Tuned screen grid amplifier with band-pass input—semi-a-periodic screen grid H.F.—grid detector—power pentode. Metal oxide rectifier. **Controls:**—(1) Tuning with vertical illuminated dial. (2) Volume and on-off switch. (3) Waverange and tone control. **Price:**—18 gns.

Makers:—McMichael Radio Ltd., Slough, Bucks.

It is refreshing in these days of stereotyped designs to find a receiver with so many marks of individuality. Not least of these is the well-proportioned and symmetrical cabinet design in which the layout of the controls blends happily with the radiating lines of the twin loud speaker frets and the walnut quartering of the front panel.

Excellent as is the performance of the set from the point of view of range and selectivity, it is the loud speaker reproduction which first attracts attention. There is an effect of spaciousness in the quality which is difficult to define, but which definitely invests the response with a realism which is missing from sets with single loud speaker units. At distances of more than 3 or 4 feet from the set the sound emanates apparently from an area considerably greater than that of the set itself and reproduces to a certain extent the atmosphere of the concert hall.

Tone Control

The waverange selector switch has five positions—two on medium and two on long waves, and a centre position for gramophone reproduction. The alternative positions on medium and long waves enable the user to take full advantage of the wide frequency range when receiving the local station and to cut down the high-frequency response when interference is experienced from heterodyne whistles or background hiss. In the "controlled" positions there is no suggestion of woolliness, and with the normal setting the

There are two stages of high-frequency amplification without reaction, the first tuned and the second coupled by a special dual choke. The range is better than that of a single-tuned stage with reaction, and the volume and quality from Langenberg in daylight indicated that the set should fulfil every reasonable requirement from this point of view.

In Central London approximately four channels are lost on either side of the two Brookmans Park transmitters, while on the long waves Königswusterhausen cannot quite be freed from a background either of Daventry or Radio-Paris, though the latter stations are themselves easily separated.

The tuning coils are enclosed in copper screening cans of unusually large volume,

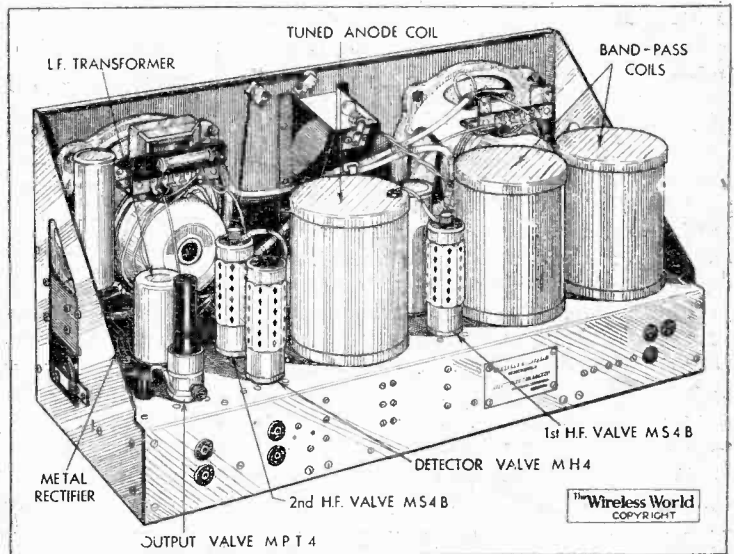

The chassis, showing twin loud speaker units. Osram "Catkin" valves are used throughout.

oxide type. The band-pass input circuit is capacity coupled at the high potential end of the tuned circuits, and the aerial loading is reduced by a capacity potential divider connected across the first tuned circuit. Both H.F. valves are of the ordinary screen grid type, and volume is controlled in the first stage by a potentiometer connected across the common bias resistance in the negative H.T. lead.

The output pentode feeds the twin moving coils through a tone-corrected output transformer. A hum-bucking coil is fitted to one of the units and the field coils are run in series, one acting as a smoothing choke. The arrangement works well, and the level of mains hum is extremely low.

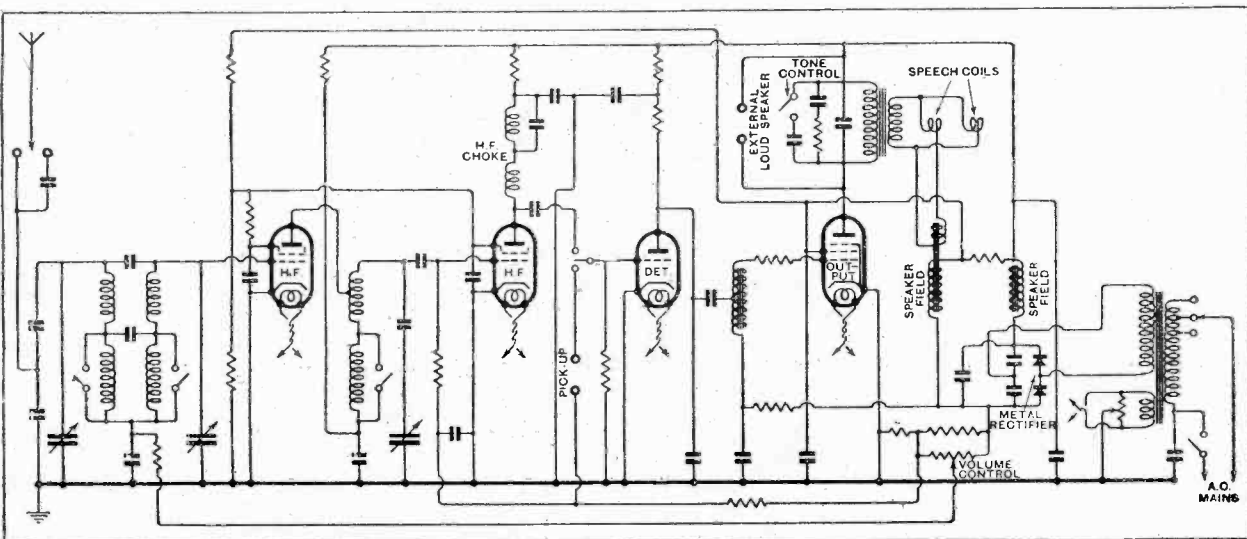

Schematic circuit diagram. A special dual choke is used in the second H.F. stage to give uniform overall amplification.

Next Week's Review:
FERRANTI
"LANCASTRIAN"
SUPERHET

D.C. SUPERHET

Constructing and Operating the New Receiver

By W. T. COCKING

IN last week's issue, constructional details of the new D.C. superheterodyne appeared, together with a description of the principles upon which its design is based. It will be remembered that the frequency-changer is preceded by a signal-frequency H.F. stage in order to secure high sensitivity without background hiss. This practice leads also to a general increase in the sensitivity, since the use of a band-pass filter at the signal frequency is avoided. The use of the Pentagrid valve as a frequency-changer also gives greater efficiency and so assists in maintaining a silent background. Of even greater importance, however, is the fact that this method of frequency changing leads to substantially constant efficiency over the waveband, and prevents the falling off so often experienced on wavelengths above about 450 metres.

The single I.F. stage in conjunction with the iron-core I.F. transformers provides adequate amplification and selectivity, with the result that it is possible to

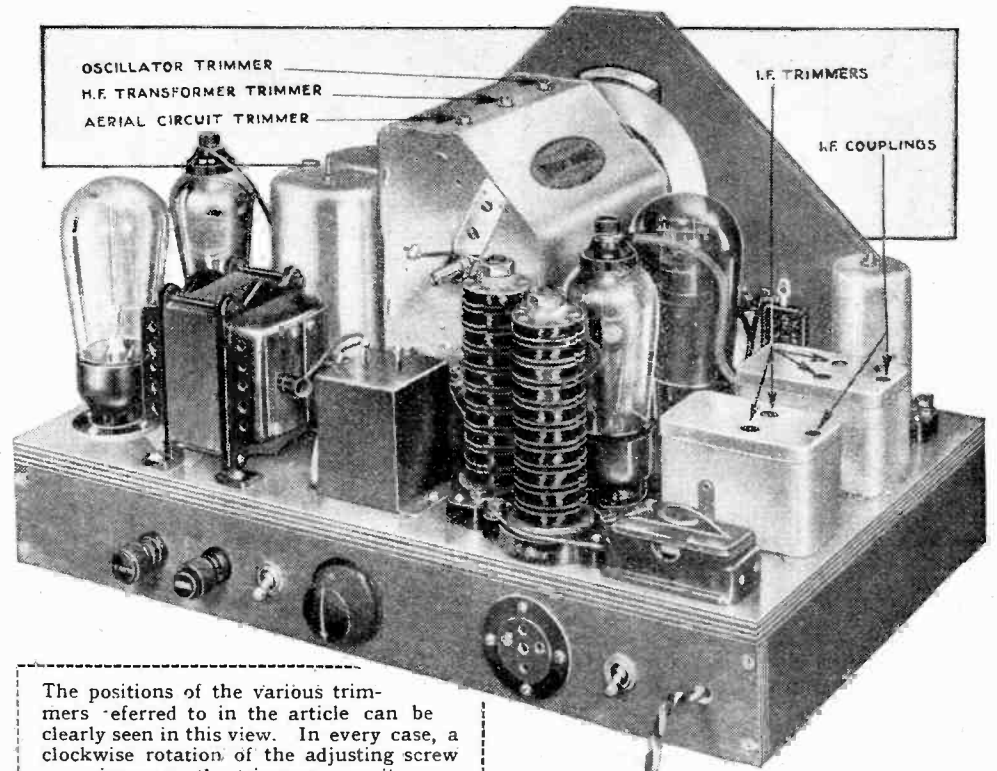

The positions of the various trimmers referred to in the article can be clearly seen in this view. In every case, a clockwise rotation of the adjusting screw increases the trimmer capacity

output valve without subsequent amplification.

One of the most important practical results of this is the complete absence of

ing; even then quite small changes in the layout may lead to deleterious effects. Owing to the absence of L.F. amplification in this receiver, however, troubles from electrostatic hum pick up are completely absent. It will be seen, therefore, that the set offers marked advantages over other types—advantages which more than compensate for the inability to use a gramophone pick-up.

Ganging the Receiver

Constructional details have already been given, and it remains to deal with the initial adjustments which must be made before the receiver can give of its best. These comprise the I.F. trimming, the I.F. coupling, and the ganging. A strong signal should be tuned in with a milliammeter connected in series with the bias resistance of the early stages at the point "X" on the circuit. A meter with a full-scale reading of 25 mA. or more should be used. In the absence of a signal the current will be the total current of the first three valves, and when a strong signal is tuned in it will drop as the A.V.C. system comes into action. The greater the change of current (the smaller the total current) with a signal, the stronger the signal. Each I.F. trimmer must then be adjusted in turn for the greatest change of current; the coupling screws should be adjusted also for maximum change of current.

The ganging can then be tackled. Set the oscillator trimmer (front section) nearly

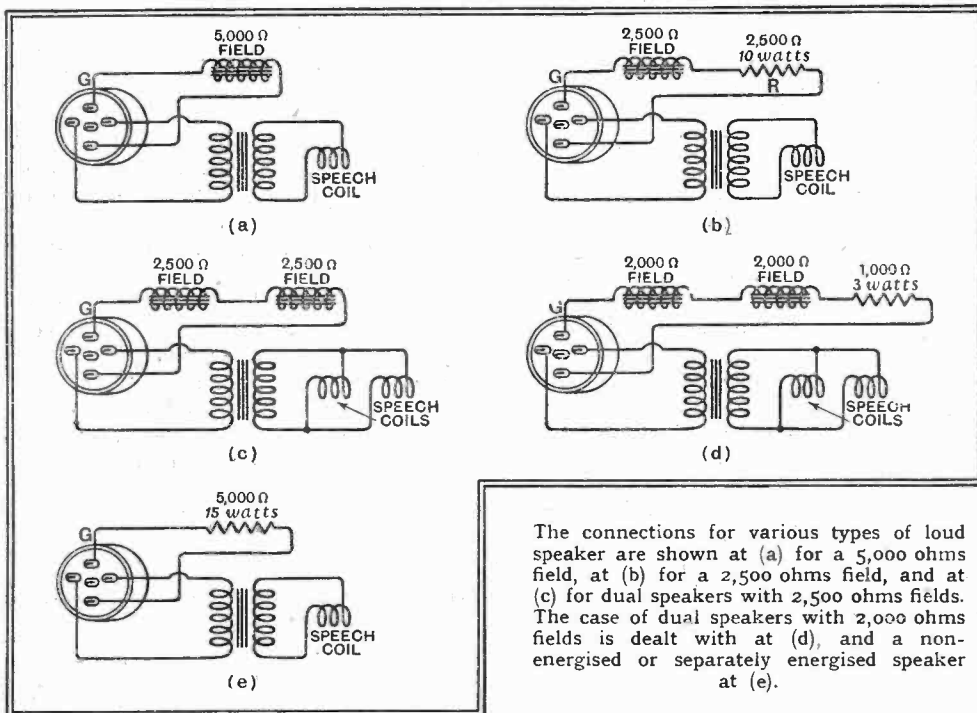

The connections for various types of loud speaker are shown at (a) for a 5,000 ohms field, at (b) for a 2,500 ohms field, and at (c) for dual speakers with 2,500 ohms fields. The case of dual speakers with 2,000 ohms fields is dealt with at (d), and a non-energised or separately energised speaker at (e).

feed the second detector with an input of 9 volts or more. Two Westectors, therefore, provide a compact and inexpensive second detector and A.V.C. system, and are capable of fully loading the pentode

hum on normal mains supplies. It is well known that the detector grid circuit causes most trouble in a D.C. mains receiver, and in order to avoid hum it is often necessary to adopt complete screen-

D.C. Superhet—

at minimum, tune in a station on as low a wavelength as possible, preferably below 250 metres, and adjust the two pre-selector trimmers for maximum signal strength as indicated by minimum current on the meter. Then tune in a station around 500 metres and adjust the oscillator trimmer while rocking the gang condenser backwards and forwards over a few degrees until the optimum combination of settings be found. Then return to the low wavelength station, and readjust the pre-selector trimmers.

The I.F. Circuits

If the dial supplied be of the wavelength calibrated type, the operation may be simplified somewhat by setting the dial to read the wavelength of a local station, such as London National, and then tuning in this station by means of the trimmers. If the calibration be accurate, the ganging should then hold, but it is advisable to carry out the process described above as a check. If no meter be available for an indicator the adjustments can be carried out for optimum signal strength as judged aurally. It will then be necessary, however, to choose weak stations, so that A.V.C. does not come into action.

The long wave ganging is next carried out, and here it is necessary to remove the panel in order to adjust the trimmer, for this can only be reached through a hole in the front of the Radiopak. In most cases only slight adjustment is needed, and it is best done by tuning in a long wave station, such as Radio Paris or Huizen, and adjusting it while rocking the gang condenser backwards and forwards over a few degrees until the optimum combination of settings be found. The panel can then be replaced, for no further adjustment will be required.

The I.F. couplings should next be adjusted for the best quality of reproduction

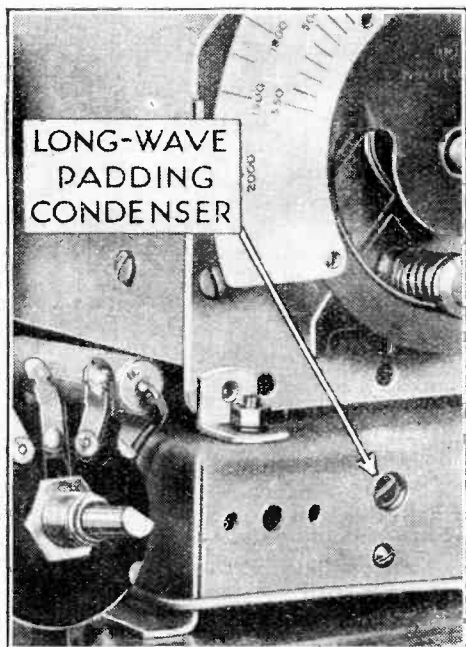

The long-wave padding condenser is operated by a screw which can be reached through a hole in the front of the Radiopak.

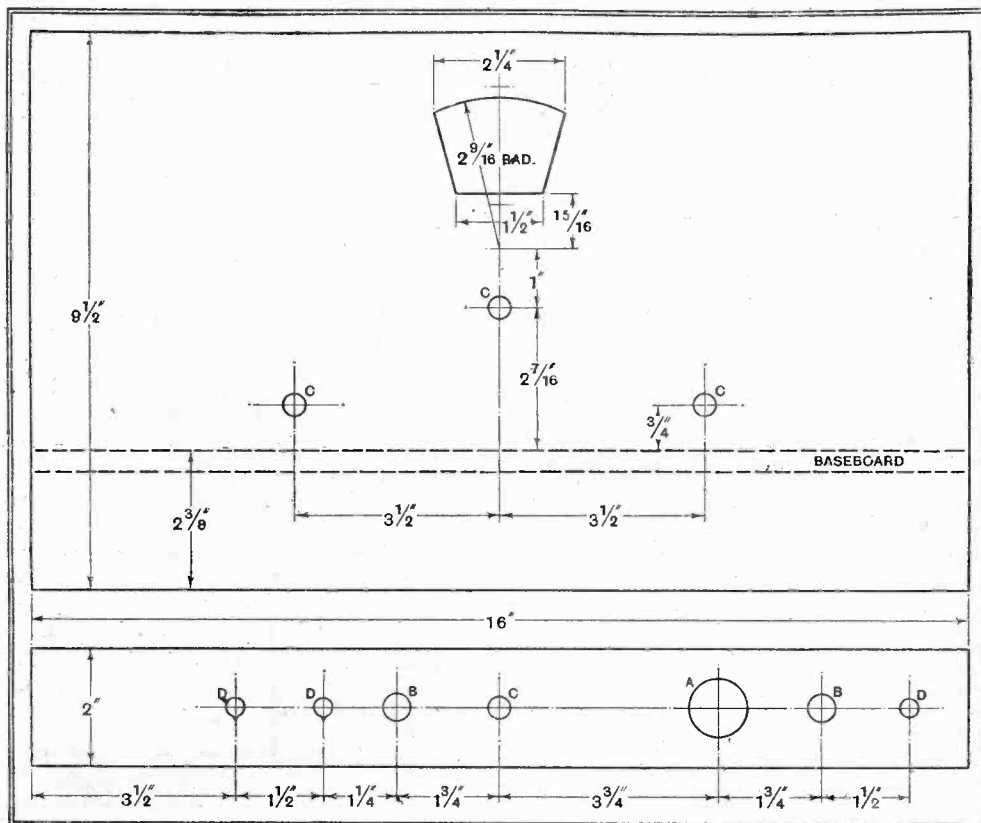

Drilling dimensions for the front panel and terminal strip of the D.C. Superhet are shown here.

with the particular speaker used. A true band-pass effect is not necessary, since the pentode provides automatic tone correction in conjunction with the average speaker, and the capacity of the by-pass condenser C15 is insufficient materially to affect the quality. It may be found that at certain trimmer settings a motor-boating effect occurs with the manual volume control at maximum on a very strong signal. This is usually a sign that the I.F. circuits are too loosely coupled, for this leads to abnormally high I.F. amplification, and a tendency towards overloading in the I.F. and output stages on a strong signal. The effect is not of great importance, for it occurs only when the output valve is overloaded, and it is not true motor-boating. Its presence can, in fact, be taken as a warning of overloading, and it prevents bad quality from being obtained through the maladjustment of the controls.

As the speaker field is used to increase the current through the heater of the 6A7 valve, it is important that it should have the correct resistance, or that its resist-

ance should be made artificially equal to 5,000 ohms. The connections for a number of the more common field resistances, therefore, are illustrated, and are self-explanatory. In the case of a non-energised or a separately energised field, a 5,000 ohms 15 watts resistance is needed. As resistances of this high rating are not common, it may sometimes be more con-

A full-size blue print of the wiring connections is available from the Publishers, price 1/6 post free.

venient to employ instead two series-connected 2,500 ohms resistances, each of 10 watts rating.

A Table of voltages and currents is included in this article, and it is a wise plan to check over the receiver to make sure that the existing conditions are correct. Even with a mains voltage the same as that used when preparing the Table, variations will occur in individual cases, and discrepancies of 10 per cent. can usually be ignored. With mains of higher

TABLE OF VOLTAGES AND CURRENT.

Valve.	Anode Volts.	Screen Volts.	Grid Volts.	Anode Current.	Screen Current.
H.F. V.D.S.	180	80	-2.4	10	0.6
Frequency changer 6A7—					
Tetrode	180	80	-2.4	10.7	1.1
Oscillator	130	—	—	1.5	—
I.F. V.D.S.	180	80	-2.4	10.2	0.7
Output D.P.T.	168	180	-9.1	31	5.8

Mains voltage = 220 volts. Total current = 0.35 ampere. Total power on 220 volts supply = 77 watts. All measurements taken with Avometer, no input signal, and Local-Distance switch at distance. The voltage readings will vary somewhat with different meters, and both voltages and currents will vary lightly with different mains voltages.

D.C. Superhet—

or lower voltage, of course, the voltages and currents will vary accordingly. Furthermore, the different loads imposed by different voltmeters will introduce discrepancies, so that it must not be expected that the figures will be exactly reproducible, and they are given chiefly as a guide to the correct operating conditions.

On test the receiver gave a good account of itself. All the principal continental stations gave sufficient detector output fully to load the output valve, and in daylight stations such as Langenberg, Brussels, North Regional, Huizen, Paris, Deutschlandsender, Luxembourg, and Fécamp would all give full loud speaker volume and bring the A.V.C. system into action. This latter circuit proved so effective that little change in volume between the London Regional, at about fifteen miles, and Langenberg was noticeable.

The adjacent channel selectivity was of a high order, and it proved easily possible

to receive the Deutschlandsender clear of any serious interference from Daventry National while using an I.F. coupling adjustment giving exceeding high quality. With sensitive speakers the volume obtainable is adequate for most requirements, and the quality of reproduction proved on test to be of an exceptionally high order. Second-channel interference was negligible, except at two points corresponding to received frequencies lower than those of the locals by twice the intermediate frequency. Background noise was unusually low, and hum was completely absent.

The performance obtained thus amply justifies the policy of increasing the pre-detector amplification and reducing the L.F., for the high quality and absence of hum are to be attributed directly to this. The sole practical disadvantage of the inability to use a gramophone pick-up is a small price to pay for the undoubted advantages of the apparatus as a receiver.

the B.B.C. then let us have the request for a postcard given out in *the News Bulletin*; it is the only possible way of getting anywhere near the correct number of "lookers."

In conclusion, if *The Wireless World* wants to have a finger in the television pie, why not do it properly and give us a few television articles. It has, after all, been going as an "amateur" science for some six years!

Southfleet, Kent. S. FALLOON.

The Wireless World**A.V.C. THREE**

See Announcement on page 285

LIST OF PARTS TO BE USED

After the particular make of component used in the original model, suitable alternative products are given in some instances.

- 1 3-gang Variable condenser and disc drive
J.B. "Nugang" No. 2054
(British Radiophone, Polar.)
- 1 Variable Condenser, 0.0002 mfd. Ormond R/507
- 1 Knob for above Ormond R/355
- 1 Iron core coil Wearite "Nucleon" B.P.1
- 1 Iron core coil Wearite "Nucleon" B.P.2
- 1 Iron core coil Wearite "Nucleon" T.C.
(Colvern, Varley.)
- 1 Transformer Multitone "Toco" 1:4
- 1 Tone control potentiometer for use with above Multitone
- 1 Volume control potentiometer, 250,000 ohms, tapered
Watmel T4
(Claude Lyons, Magnum, Rothermel.)
- 1 H.F. choke Wearite HFP
- 1 H.F. choke Wearite HFPA
(Kinva, McMichael.)
- 1 Power smoothing choke, 30 henrys 50 m.a. Davenset No. 101
(R.I., Sound Sales, Varley.)
- 1 Mains transformer, 200 to 250 volts, 50 cycles
Secondaries: 275-0-275 volts, 4 volts, 2.5 amps centre-tapped, 4 volts 4 amps, centre-tapped.
Vortexion A.C.34
(British Radio Gramophone Co., Bryce, Challis, Davenset, Claude Lyons, Sound Sales.)
- 4 5-pin Valve holders Clix Chassis Mounting
Air Sprung Type
- 1 7-pin Valve holder Clix Floating Type
(W.B.)
- 2 Fixed condensers, 0.0001 mfd. Telsen W.207
- 1 Fixed condenser, 0.0005 mfd. Telsen W.211
- 1 Fixed condenser, 0.25 mfd. 500v. D.C. test Telsen W.229
- 1 Fixed condenser, 0.05 mfd. 500v. D.C. test Telsen W.227
- 1 Fixed condenser, 1 mfd. 500y. D.C. test Telsen W.227
- 2 Fixed condensers, 2 mfd., 500v. D.C. test Telsen W.226
- 5 Tubular condensers, 0.1 mfd. 1,500v. D.C. test Telsen W.411
- 2 Tubular condensers, 0.005 mfd. 1,500v. D.C. test
(Graham Farish.)
- 1 Dry electrolytic condenser, 4 mfd. 500 working peak voltage Telsen W.408
- 1 Dry electrolytic condenser, 8 mfd. 500 working peak voltage Telsen W.396
- 1 Dry electrolytic condenser, 25 mfd. 25 volts. Telsen W.398
- 1 Dry electrolytic condenser, 25 mfd. 25 volts. Telsen W.399
(Dubilier, Peak, T.C.C.)
- 1 Resistance, 200 ohms Graham Farish Ohmits
1 1/2 Watts Type
- 1 Resistance, 250 ohms ditto
- 1 Resistance, 1,000 ohms ditto
- 1 Resistance, 2,000 ohms ditto
- 1 Resistance, 7,000 ohms ditto
- 2 Resistances, 10,000 ohms ditto
- 1 Resistance, 17,500 ohms ditto
- 2 Resistances, 20,000 ohms ditto
- 1 Resistance, 25,000 ohms ditto
- 1 Resistance, 100,000 ohms ditto
(Dubilier, Erie, Claude Lyons, Ready Radio, Varley.)
- 1 Grid leak, 2 megohms Graham Farish Standard Type
- 1 Grid leak, 0.5 megohm ditto
(Dubilier, Erie, Claude Lyons, Ready Radio, Varley.)
- 2 Switches, on-off Claude Lyons 728
- 1 Switch single-pole change-over Claude Lyons 729
(British Radiophone, Bulgin.)
- 1 5-pin plug Bulgin P.3
(British Radio Gramophone Co.)
- 1 Length screened sleeving Harbros
- 4 Ebonite shrouded terminals, A, E, Pick-up (2) Belling-Lee Type B
- Wood panel, 1/4ply, 15in. x 8 1/2in.
- Plymax Baseboard, 12in. x 15in. x 3/8in. Peto-Scott
2oz. No. 20 tinned copper wire, 6 lengths Systoflex,
Wire, Wood, Paxolin, Flex, etc.
- Screws: 19 1/4in. No. 4 R/hd., 18 1/4in. No. 4 C/sk., 86
1/4in. No. 4 R/hd., 1 6BA 1 in R/hd. with nut and washers.
- Valves:—1 Osram or Marconi MHD4, 1 Osram or Marconi MU12, 1 Mazda AC/Pen., 1 Ferranti VPT4, or Mullard YP4.

Letters to the Editor

The Editor does not hold himself responsible for the opinions of his correspondents

Correspondence should be addressed to the Editor, "The Wireless World," Dorset House, Stamford Street, London, S.E.1, and must be accompanied by the writer's name and address

Eliminating Interference

IN connection with Mr. Willans' letter in your issue of Sept. 8th re split field windings for reducing interference from motors, may I point out that this method has been tried by the P.O. engineers for (as far as I recollect) trams and trolley buses.

In an earlier report (see "Radio Activities," *Elect. Times*, p. 156, July 24th, 1930) this method is said to have been found effective with trolley buses at Birmingham.

It appears that later (Angwin, *Instn. P.O. Elect. Eng. Paper No. 137*) it was found that the distance of the field coils from the feeders tends to reduce the effectiveness—hence the present practice of fitting "stopper coils" to the trolley leads, as close to the feeders as practicable.

London, W.3. S. N. RAY.

The Control Man Again

MAY I ventilate an old grievance of the listening public, viz., the misdirected operating of output control of certain kinds of music at the B.B.C.? At one time this seriously interfered with the enjoyment of nearly all music. Let me gratefully acknowledge an enormous improvement in this respect, but the nuisance has been revived recently in connection with organ broadcasts. During passages obviously intended to be soft and delicate the power has been increased until background noises were out of all proportion. Then, of course, an unexpected change to more or less full organ caused the control operator to shut off suddenly as if the organist had rapidly closed in his great organ. There is no mistake about this; it happened a short time ago during a recital from Coventry Cathedral, and also in a recital from the Church of the Messiah, Birmingham, neither of which organs are totally enclosed; the organists themselves could not possibly have produced these effects.

Doubtless, in connection with outside

broadcasts, the control engineer is placed in a difficulty, but there is no reason why the primary difficulties in placing of microphones at the source of sound should not be patiently studied and overcome. It would be better to make very soft passages nearly inaudible, or for the organists to be made acquainted with the necessary technique for broadcasting from particular buildings and instruments, than for this irritating sort of adjustment to be made at the engineering control during an item.

London, S.E.20. W. C. BURBRIDGE.

Television—A Reader's Grouse

IN a recent issue you congratulate yourselves that the B.B.C. took up your suggestion for a television census. If, as you fondly believe, the B.B.C. took the hint from *The Wireless World*, then you are responsible for the most foolish and mischievous piece of work that radio has experienced for some time.

Did it occur to you that in the very middle of the summer not one television enthusiast in ten would have his set in action? Of those who were experimenting the very few would actually catch the announcement concerning the census, owing to the time, which is so short, being devoted to adjustment and alteration of apparatus.

This postcard census would thus in all probability catch about five or ten per cent. of the real television audience.

I can claim acquaintance with about twenty television workers, but I know that only two or three at the most have their sets assembled at the moment.

If a single individual like myself knows some twenty "lookers-in" then surely it is safe to estimate the "phantom" audience at 2,000 at the very least; an estimate like 500, which has somewhere been made, is absurd and shows a complete lack of "touch" with this branch of wireless.

If *The Wireless World* has the "ear" of

LABORATORY TESTS

NEW RADIO PRODUCTS REVIEWED

VARLEY NEW R.C.C. AND NICORE A.V.C. UNITS

THE Compensating R.C.C. Unit is a resistance-capacity coupling device designed to give correction for the loss in the upper register that invariably accompanies the use of very selective tuned circuits. It

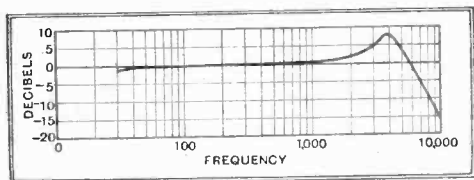

Curve showing order of correction afforded by the Varley Compensating R.C.C. unit.

has a characteristic which is sensibly flat up to 1,500 c/s, after this it begins to rise and eventually attains a maximum at about 3,600 c/s. Beyond this point there is a comparatively rapid decline. Compensation for high note loss is achieved, however, without detracting from its performance over the middle and lower registers for at frequencies up to 1,500 c/s the unit functions as a straightforward resistance-capacity coupling device. To obtain the full measure of correction a valve of comparatively high impedance should precede the unit, and for the purpose of our tests one of 18,000 ohms A.C. resistance was employed. The curve here reproduced shows the degree of compensation that may be expected under normal operating conditions. The unit costs 11s. 6d.

Another new Varley product is the Nicore A.V.C. unit. This enables automatic volume control to be incorporated in almost every type of receiver in a simple manner and with the minimum of alteration in the design or layout of the components. From our tests it would appear that best results are obtained in super-heterodyne receivers, as the A.V.C. volts provided by the unit are greater at the lower carrier frequencies. For with 0.5 volt fed to the grid of a detector valve the A.V.C. volts developed were 7.3 at 110

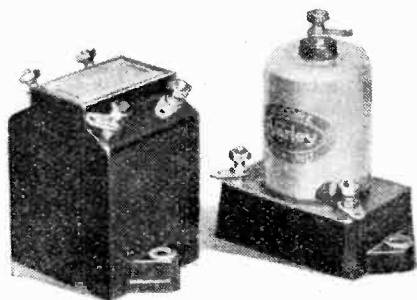

Varley Compensating R.C.C. and A.V.C. units, the latter includes an H.F. choke.

kc/s and 1.75 at 600 kc/s. The A.V.C. unit costs 15s. 6d., and the makers are Varley (Oliver Pell Control, Ltd.), Kingsway House, 103, Kingsway, London, W.C.2.

BRITISH RADIOGRAM MAINS TRANSFORMER

A MAINS transformer for use in receivers embodying two or three valves and an A class rectifier has been sent in for test by the British Radio Gramophone Co., Ltd., Pilot House, Church Street, Stoke Newington, London, N.16. This component is listed as the Type 55 and provides 250+250 volts at 60 mA, 4 volts at one amp. for the rectifier filament and 4 volts at 3 amps. maximum for the A.C. valves. The primary is tapped for supply mains of from 200 to 250 volts, the various leads from this coil being brought out to a terminal strip. Terminals are not provided for the secondary windings but the leads are left sufficiently long to join to their respective points and a colour scheme is adopted for identification.

On test the smoothed D.C. output was found to be 338 volts at 10 mA, 316 volts

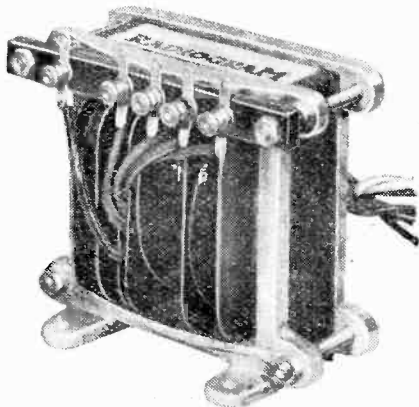

British Radiogram A type mains transformer model 55

at 20 mA, 296 volts at 30 mA, 278 volts at 40 mA, 260 volts at 50 mA, and 243 volts at 60 mA. The smoothing choke had a resistance of 300 ohms, and 4-rfd. condensers of 400 volts working were used. The H.T. secondary is well regulated and accounts for a 5 per cent. voltage drop only on full load. Under these conditions the rectifier filament was operated at 3.83 volts while 3.81 volts were given at 3 amps. by the remaining L.T. winding. These are just within the tolerance permitted for the A.C. valves, but precautions must be taken to avoid voltage drop in any extension of the filament leads.

The transformer is strongly made, the inter-winding insulation is very good, there is no indication of over-heating and the price is 21s.

K-P SMOOTHING CHOKE

MADE by K-P Instruments, Aerial Works, Blackheath, London, S.E.3, the type 20/100 smoothing choke is one of a new range introduced for heavy duty work, the model in question being rated to carry up to 100 mA of D.C. while maintaining an inductance of the order of 20

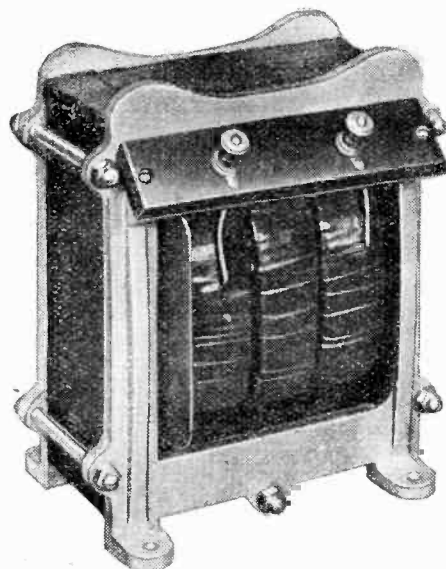

K-P heavy-duty choke model 20/100.

henrys. The choke is assembled on a massive iron core, the coil being in three sections, each separately insulated and wound with silk covered wire of heavy gauge. Its D.C. resistance is low, being but 165 ohms, so that when passing the maximum current of 100 mA the potential drop across the choke amounts only to 16.5 volts.

Measured at 50 c/s and with 5 volts A.C. applied to the choke its inductance with various amounts of D.C. flowing is as follows:—

The well-maintained inductance is due largely to the very generous size of the core, but it is further assisted by the inclusion of an air gap, and from our measurements it would seem that

D.C. in mA.	Inductance in Henrys.
0	38.4
20	37.3
40	36
60	33.8
80	31
100	26

this gap has been correctly chosen having regard to the magnitude of the D.C. currents the choke is intended to carry.

The workmanship and finish are of an exceptionally high standard and at 39s. 6d. the choke represents excellent value for money. This firm manufactures also a range of mains transformers of the same quality in addition to which they are in a position to supply these components wound to customers' specifications.

The Radio Industry

THOSE interested in the performance obtainable with modern sets should note that demonstrations are now given by Haynes Radio at Queensway, Enfield, Middlesex, every Friday evening from 6.30 to 9.30. All types of receiver in the firm's range of products, including short-wave sets, are demonstrated in the Servicing Department.

The premises can be reached by train to Enfield Town or Enfield Chase, thence by tram along Southbury Road.

Catalogues Received

Radio Instruments, Ltd., Purley Way, Croydon, Surrey.—Catalogue of R.I. components, with technical data, particularly with reference to the new "Micron" iron-cored tuning coils.

City Accumulator Co., Ltd., 18-20, Norman's Buildings, Central Street, London, E.C.1.—Full descriptions of the C.A.C. receivers, and also illustrations of many attractive cabinets, including one for the New Monodial. In loose-leaf form.

READERS' PROBLEMS

Earth Everything

IT is wise to make it a rule, when building a receiver, to earth all metal objects that would otherwise be "free." This applies to such things as coil covers, transformer shrouds, condenser containers, and the metal braiding of screened wires.

It should be remembered that the necessary earthing is generally provided automatically when a set is assembled on a metal chassis. A reader, who proposes to use a wooden framework for a design where metal was originally specified, should remember this point and provide the necessary extra earthing connections.

Negative or Positive ?

A READER, who intends to supplement his present H.T. supply (obtained from a 100-volt house-lighting battery) with a 50-volt accumulator battery, asks for advice as to whether the extra cells should be connected on the positive or negative side of the mains. Neither side is earthed.

This is probably not a matter of any great importance, but we recommend that connection should be made as in Fig. 1 (a). Results could certainly be obtained from the alternative form of connection shown in diagram (b), but the results of an accidental earth connection on the mains or of leakage would be to impose a complete or partial short-circuit across the high-tension battery.

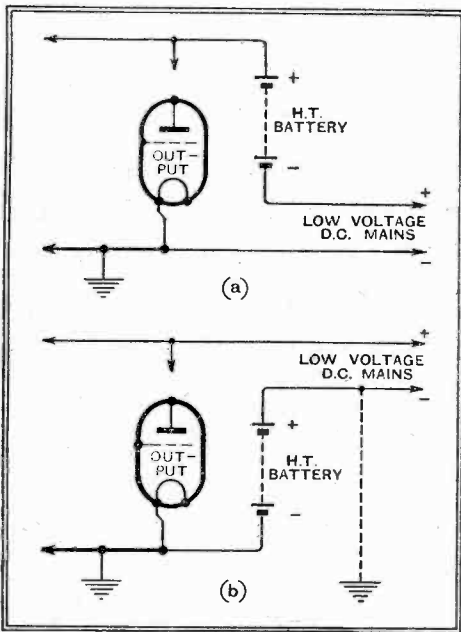

Fig. 1.—How to connect a supplementary H.T. battery in series with a house-lighting system. Diagram (b) shows, by dotted lines, how a short-circuit may be introduced by connecting the battery incorrectly.

This short-circuit would take place through "earth" by the path indicated in dotted lines, but it could admittedly be prevented by earthing the set through a condenser.

Bias Affects Voltage

A CORRESPONDENT seems to be slightly perturbed because the reading of a voltmeter, which is semi-permanently connected across the main H.T. output of his eliminator, shows slight but quite definite voltage changes when the output valve grid bias is altered experimentally.

THESE columns are reserved for the publication of matter of general interest arising out of problems submitted by our readers.

Readers requiring an individual reply to their technical questions by post are referred to "The Wireless World" Information Bureau, of which brief particulars, with the fee charged, are to be found at the foot of this page.

We would reassure him by saying that, in the circumstances, some slight variation in voltage is inevitable, though with large and generously designed power equipment it may be barely perceptible. By increasing bias the output valve anode current is reduced, and so it is natural that a voltage rise should take place in the eliminator.

Conversely, the output valve will tend to take more current when its bias is reduced, and so a fall in voltage is to be expected as a result. No ordinary eliminator can be expected to maintain an absolutely constant voltage under varying loads.

If the A.V.C. is Working

THE only practicable way of making a definite test of the working of a "delayed" automatic volume control system is to insert a milliammeter in the anode circuit of one or more of the controlled valves; the current registered by the meter will, if everything is well, fluctuate in sympathy with the strength of all incoming signals above a certain critical intensity.

It is worth while knowing that, in the absence of a meter, fairly conclusive proof of the proper functioning of the control is afforded by the fact that background noises are greatly reduced in strength when the set is tuned to a strong carrier wave; the stronger the carrier the quieter the background.

Conversely, of course, noises should increase on tuning the circuits to a wavelength on which no transmission is taking place. In this condition all the controlled valves will be working at maximum sensitivity, as automatic control can do nothing to desensitise the set unless a steady carrier wave is being received. Naturally, these remarks do not apply to sets with "quiet" A.V.C. but few include a fully automatic system of this type.

This simple test is suggested to a reader who is using a factory-built set in which it is inconvenient to insert a meter; our querist suspects that the automatic control system has developed a fault.

The Wireless World INFORMATION BUREAU

THE service is intended primarily for readers meeting with difficulties in the construction, adjustment, operation, or maintenance of wireless receivers described in *The Wireless World*, or those of commercial design which from time to time are reviewed in the pages of *The Wireless World*. Every endeavour will be made to deal with queries on all wireless matters, provided that they are of such a nature that they can be dealt with satisfactorily in a letter.

Communications should be addressed to *The Wireless World* Information Bureau, Dorset House, Stamford Street, London, S.E.1, and must be accompanied by a remittance of 5s. to cover the cost of the service. The enquirer's name and address should be written in block letters at the top of all communications.

Anode By-pass Capacity

FROM the point of view of sensitivity, a much larger by-pass condenser than usual may with advantage be shunted between the anode of the detector valve and earth. In fact, if the question of quality be ignored, one may go on adding to its capacity almost indefinitely with some advantage; the only exception to this is that reaction control may become impossible after a certain limit is exceeded.

A correspondent who appreciates these points has tried the effect of increasing his detector anode by-pass capacity with disappointing results. The addition of a relatively large parallel condenser (C in Fig. 2) had no obvious effect.

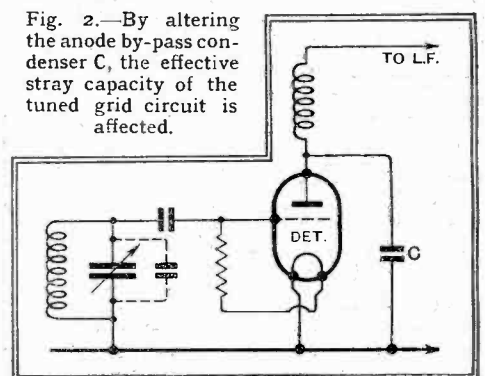

Fig. 2.—By altering the anode by-pass condenser C, the effective stray capacity of the tuned grid circuit is affected.

We are inclined to think that this correspondent has ignored the fact that, by adding capacity in this position, the grid-circuit tuning of the detector valve has been disturbed. His receiver is gang-tuned, and he would be well advised, after making any alteration that is likely to upset tuning, to readjust the detector grid circuit trimming condenser. It is not always realised that, due to its effect on input capacity, an alteration in the anode circuit may make this course necessary.

Defective at One Wavelength Only

INFORMATION is requested as to the probable nature of a fault which manifests itself by an intermittent noise or even by a momentary cessation of signals over a narrow waveband (approximately 380-395 metres). Apart from this trouble, the set, which embodies a "straight" two-H.F. circuit, is entirely satisfactory.

We can think of no more likely cause of this trouble than a short-circuit in one or more sections of the ganged tuning condenser. Very possibly there is some trifling defect, such as a small projecting piece of metal on one of the condenser vanes, which introduces a complete or partial short-circuit at one setting only.

A Less Effective Filter

IN the new Monodial receiver, heterodyne whistles may be avoided in almost every case by switching into circuit the low-pass filter which is included in the L.F. amplifier. This is an important part of the design, and we would strongly dissuade readers from fitting some less perfect form of filter.

High-note filters of the more usual and simpler type may admittedly offer a certain amount of immunity from interference, but will be less effective than a proper filter, and, worse still, will impair quality to a much greater extent.

The Wireless World

THE
PRACTICAL RADIO
JOURNAL
23rd Year of Publication

No. 737.

FRIDAY, OCTOBER 13TH, 1933.

VOL. XXXIII. No. 15.

Proprietors: ILIFFE & SONS LTD.

Editor:
HUGH S. POCOCK.

Editorial,
Advertising and Publishing Offices:
DORSET HOUSE, STAMFORD STREET,
LONDON, S.E.1.

Telephone: Hop 3333 (50 lines).
Telegrams: "Ethaworld, Watloo, London."

COVENTRY: Hertford Street.

Telegrams: "Cyclist, Coventry."
Telephone: 5210 Coventry.

BIRMINGHAM:

Guildhall Buildings, Navigation Street, 2.

Telegrams: "Autopress, Birmingham."
Telephone: 2970 Midland (3 lines).

MANCHESTER: 260, Deansgate, 3.

Telegrams: "Iliffe, Manchester."
Telephone: Blackfriars 4412 (4 lines).

GLASGOW: 26B, Renfield Street, C.2.

Telegrams: "Iliffe, Glasgow." Telephone: Central 4857.

PUBLISHED WEEKLY. ENTERED AS SECOND
CLASS MATTER AT NEW YORK, N.Y.

Subscription Rates:

Home, £1 1s. 8d.; Canada, £1 1s. 8d.; other
countries abroad, £1 3s. 10d. per annum.

As many of the circuits and apparatus described in these
pages are covered by patents, readers are advised, before
making use of them, to satisfy themselves that they would
not be infringing patents.

CONTENTS

	Page
Editorial Comment	297
A.V.C. Three	298
Television Progress	302
FOREIGN PROGRAMME	
SUPPLEMENT, pp. I—XXIV	
Practical Hints and Tips	305
Radio Luxembourg	306
Visual Tuning Indicator	307
News of the Week	308
Broadcast Brevities	309
Letters to the Editor	310
Ferranti "Lancastria" Superhet	311
New Apparatus Reviewed	312

EDITORIAL COMMENT

Common Waves

Limitations of the Scheme

NOW that London National and West Regional transmitters have for some time been operating on a common wavelength of 261.6 metres, the opportunity has been provided for forming an opinion as to the value of a synchronising system of this nature as a compromise to assist in overcoming the troubles of wavelength congestion in Europe.

It does not appear that the B.B.C. has any intention of continuing this twin wavelength arrangement permanently, for under their present plan, as soon as Droitwich is ready to operate as the new long-wave National transmitter, most of the remaining stations in different parts of the country will give Regional programmes alternative to the National, and the present medium-wave National programmes will cease.

This technical experiment of synchronising the London National and West Regional has been interesting, if only because it has proved to the satisfaction of most listeners, and we hope to broadcasting authorities in general, that such a scheme has very little to recommend it. The B.B.C. frankly admits that anywhere outside a reliable service range of these transmitters, which they put at approximately 40 to 50 miles, common-wave interference occurs. This interference takes the form of a beat, which so chops the reproduction that in the case of speech it gives the impression that the speaker is stuttering. These two stations, therefore, which under normal conditions (if they had wavebands to themselves) would have an after-sunset range which we may conservatively place at 200 miles, can now serve no more than a local area.

Common wavelength schemes of this nature would, it appears, prove worth while only where stations are very widely spaced geographically and where it is not desired that either of them should serve listeners at any distance. It would not matter, for instance, if an English station were synchronised with another in Russia, so long as it was not desired that either should be intelligible beyond its own national boundary.

Little is to be gained if, in the process of saving one wave channel, the area covered by each station is reduced to approximately one sixteenth of what might be expected of it after sunset, yet this is what does actually occur.

It is useless for the B.B.C. to regard the service area of a station as only some fifty miles radius, for if that were accepted our B.B.C. stations would fall very far short of serving the total area of the country.

The A.V.C. Three

A Receiver of Unusual Performance

HITHERTO the advantages of automatic volume control have been generally available only to owners of sets of the super-heterodyne class, or straight sets having two high frequency stages. The receiver described in this issue should, therefore, be of very special interest to our readers, as although there is only one H.F. stage, delayed amplified automatic volume control is incorporated, whilst at the same time retaining reaction.

The three-valve set is undoubtedly the most popular type of all, and now, with the addition of automatic volume control, we anticipate that this set will make a strong appeal and give excellent service in the coming winter, the automatic volume control increasing still further the interest in distant reception.

"The Wireless World"

A.V.C. Three

A Selective Three-Valve A.C. Mains Receiver with Automatic Volume Control

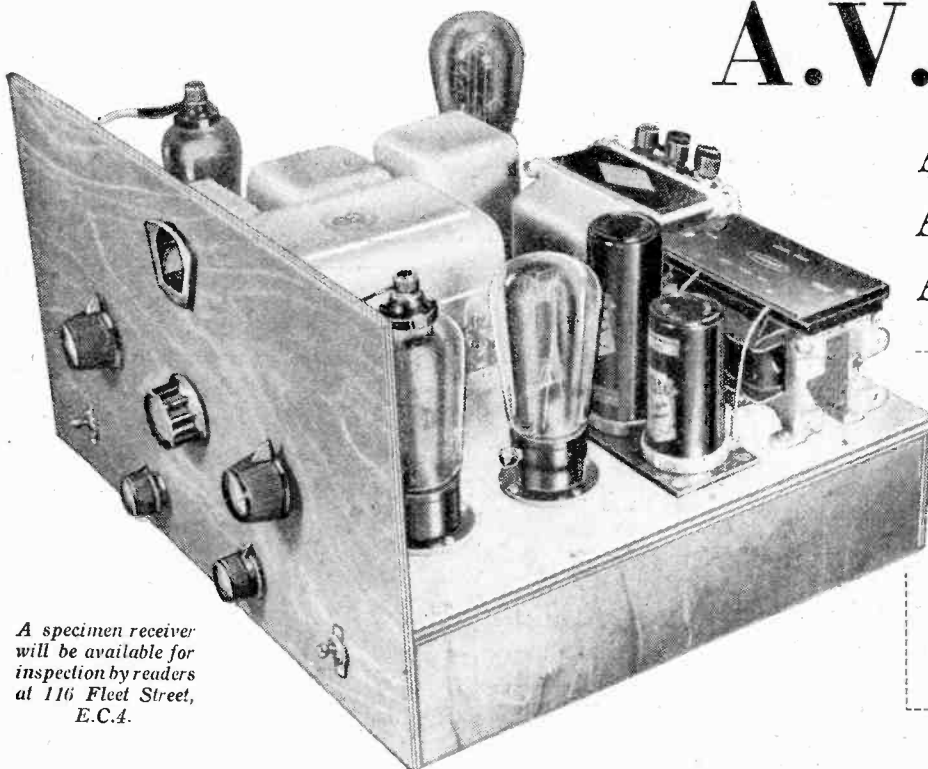

A specimen receiver will be available for inspection by readers at 116 Fleet Street, E.C.4.

DELAYED amplified A.V.C. is a form of automatic volume control which lends itself particularly well to use in the smaller class of receiver where a moderate detector input and reaction are both necessities. "The Wireless World" A.V.C. Three for the first time combines delayed amplified A.V.C. with reaction and so represents a step forward in that the disadvantages of fading with the smaller class of receiver are reduced.

THE three-valve receiver still deservedly retains its popularity, for when it is used with a good aerial it is capable of bringing in the more powerful of distant stations at good volume, while the quality of reproduction can be very satisfying. Moreover, the introduction of iron-core type tuning coils has led to such an increase in the selectivity obtainable that good results in distant reception are now possible even at short distances from the local station.

In the past, automatic volume control has not been applied with any great success to a receiver of this nature, since

the systems available either led to an inadequate control or prohibited the use of reaction, without which the maximum sensitivity is likely to be inadequate. It is possible, however, to modify the amplified A.V.C. circuit in such a manner that both good A.V.C. and reaction are obtainable.

The circuit diagram of the new receiver is shown in Fig. 1, and it will be seen that the H.F. valve, which is of the screened H.F. pentode type, is preceded by a band-pass filter employing iron-core coils. The filter coupling is of the mixed capacity type, the lower capacity being the 0.05 mfd. condenser C2 and the upper the

condenser C1. The coupling between the H.F. and detector stages is by means of a shunt-fed transformer to which reaction is applied. The primary of the transformer is fed by means of the screened H.F. choke Ch1 and the 0.0005 mfd. condenser C5, and the tuned circuit itself is connected through the 0.0001 mfd. condenser C6 to one diode of the duo-diode-triode valve which provides signal rectification, L.F. amplification, reaction, and delayed A.V.C. When the switch S2 is in the upper position on the diagram, the 0.25 meg. resistance R7 is connected between the diode anode and cathode, and it acts as the diode load resistance, and is analogous to the grid leak of an ordinary detector. There are developed across this resistance H.F. potentials due to the sig-

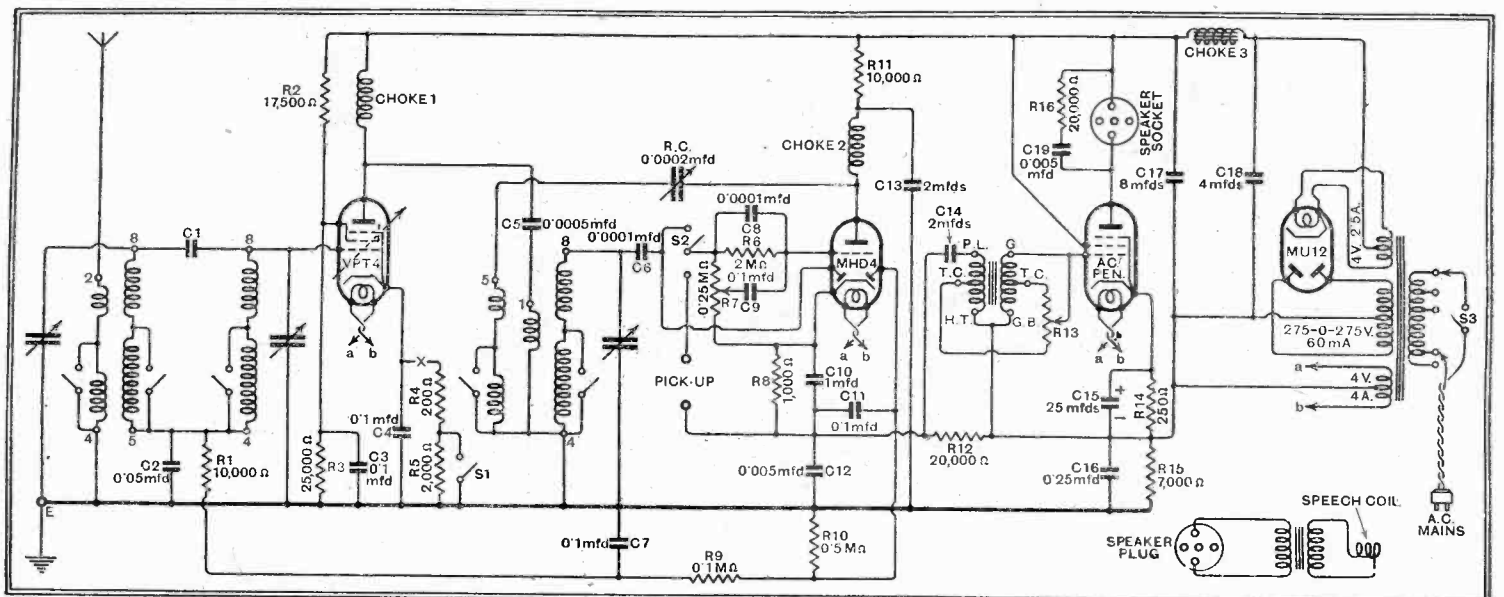
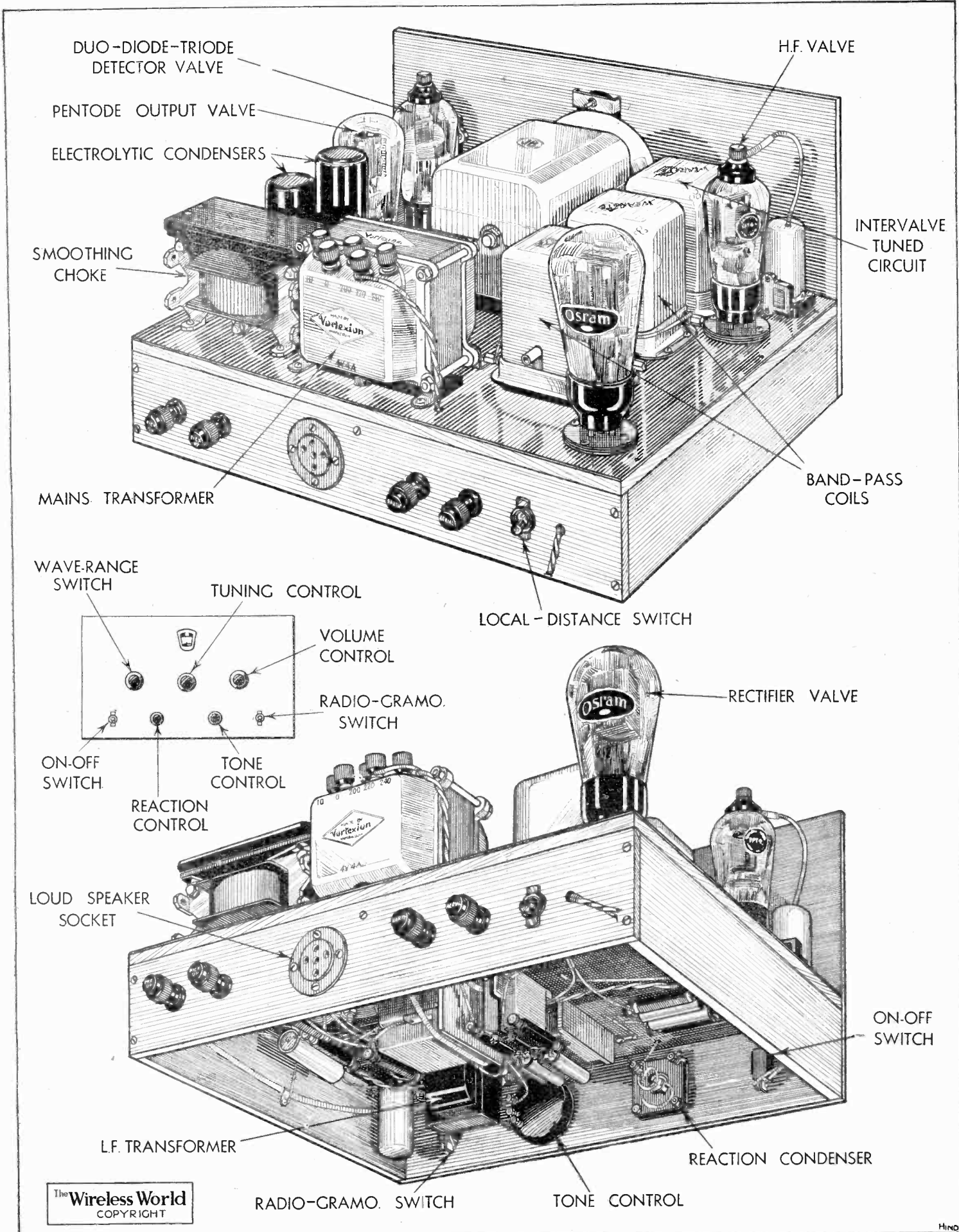

Fig. 1.—The complete circuit diagram shows that delayed amplified A.V.C. is obtained with the duo-diode-triode valve, and that this also serves to give signal rectification, L.F. amplification and reaction. The potentiometer R7 acts as the manual volume control and is operative on both radio and gramophone.

The Chassis of the New A.V.C. Set



The Wireless World
COPYRIGHT

The positions of the chief components can readily be seen in these drawings of *The Wireless World* A.V.C. Three, and it will be noted that the layout adopted is one leading to a straightforward assembly and easy wiring.

"The Wireless World" A.V.C. Three—
 nal, with L.F. and D.C. potentials due to its rectification. The latter two are applied to the triode grid in the usual way through the condenser C9 of 0.1 mfd. and the 2 megohms resistance R6, the connection of C9 being made to the slider of the resistance R7, for this serves as the manual volume control as well as the diode load resistance. The H.F. potentials are applied to the triode grid through the 0.001 mfd. condenser C8, which shunts R6. On gramophone, S2 is in the lower position on the circuit, and the pick-up is returned to the cathode through the biasing resistance R8 of 1,000 ohms shunted by the 1 mfd. condenser C10.

The A.V.C. Circuit

In the anode cathode circuit of the triode, therefore, there appear H.F. currents, L.F. currents, and a change of direct current upon the application of a signal. The H.F. currents perform their useful function in the anode circuit, and are deflected through the reaction condenser R.C. to the reaction coil by the H.F. choke Ch2. Decoupling from L.F. currents in the H.T. supply is obtained with the aid of the 10,000 ohms resistance R11 and the 2 mfd. condenser C13. The H.F. currents are not required in the cathode circuit, and are consequently by-passed by the 0.005 mfd. condenser C12.

The load resistance to L.F. currents is in the cathode circuit, and consists of the 20,000 ohms resistance R12, from which the primary of the L.F. transformer is shunted through the 2 mfd. condenser C14. Now it will be observed that the resistance R12 is returned directly to negative H.T., whereas the earth line of the set, to which the H.F. valve cathode circuit is returned, is connected to negative H.T. through the

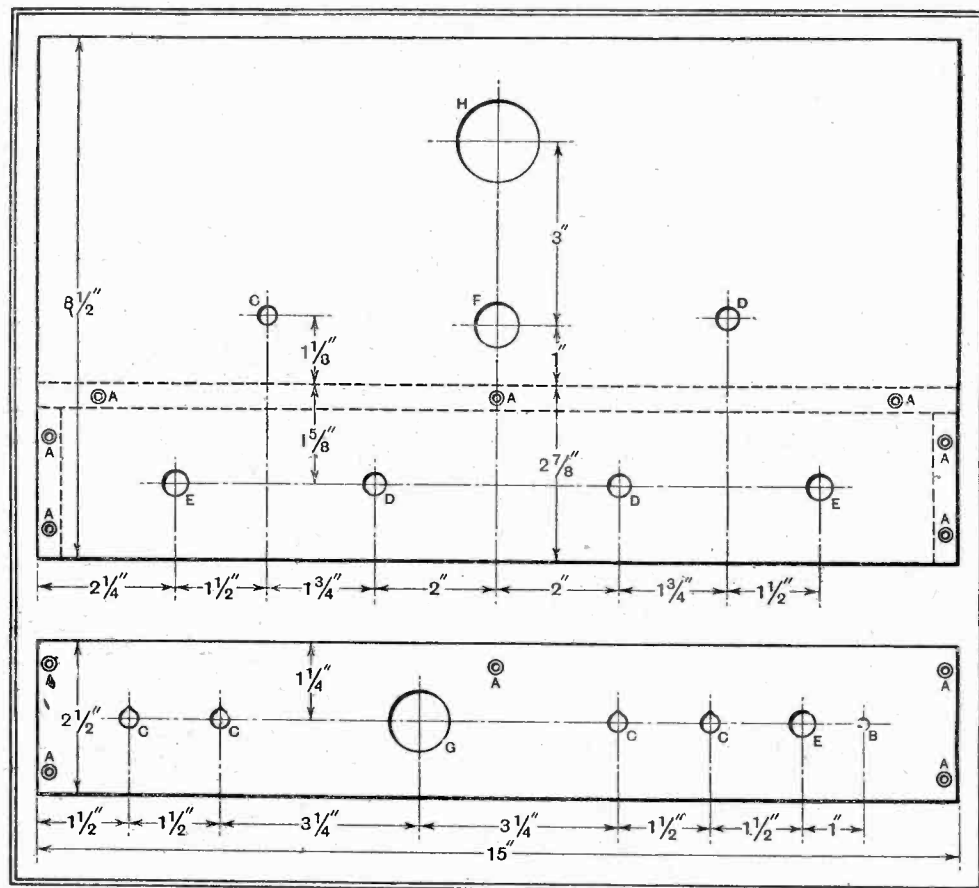

The drilling dimensions of the panel and terminal strip are shown here ; the sizes of the holes are : A = 1/8in. B = 3/16in. C = 5/16in., D = 3/8in., E = 7/16in., F = 3/4in., G = 1in., H = 1 3/8in.

7,000 ohms resistance R15 shunted by the 0.25 mfd. condenser C16. The cathode of the H.F. valve, therefore, is positive with respect to negative H.T. by the drop across R15. With no applied signal the voltage drop across R12 is greater than that across R15, so that the MHD4 cathode is more positive than the H.F. valve cathode, and is consequently positive with respect to

the earth line. Now the grid of the H.F. valve is returned to the earth line through the 10,000 ohms resistance R1, the 100,000 ohms resistance R9, and the 500,000 ohms resistance R10, the condensers C7 and C11 serving as by-pass capacities. R10 is also connected to the second diode anode, but as the cathode is positive with respect to the earth line, the anode is negative with respect to the cathode, and is non-conductive. There is thus no current flow through any of the resistances included in the H.F. valve grid circuit, and the grid potential of this stage is consequently only that provided by the minimum bias resistance R4, assuming the switch S1 to be closed.

When a signal is applied the triode grid is negatively biased as a result of rectification, and the triode anode current drops. The triode cathode becomes less positive, therefore, and if the signal be strong enough the drop across R12 becomes less than that across R15 and the cathode is then negative with respect to the earth line. The second diode anode, therefore, is positive with respect to the cathode, and it becomes conductive and assumes practically the same potential as the cathode. For all practical purposes the grid of the H.F. valve may be considered as following the potential of the triode cathode, since it is connected to it through a series of resistances, and the diode-cathode path of the valve. As the signal increases in strength, so the triode cathode becomes more and more negative with respect to the earth line, and the H.F. valve grid follows it and becomes increasingly biased negatively, thus reducing its amplification.

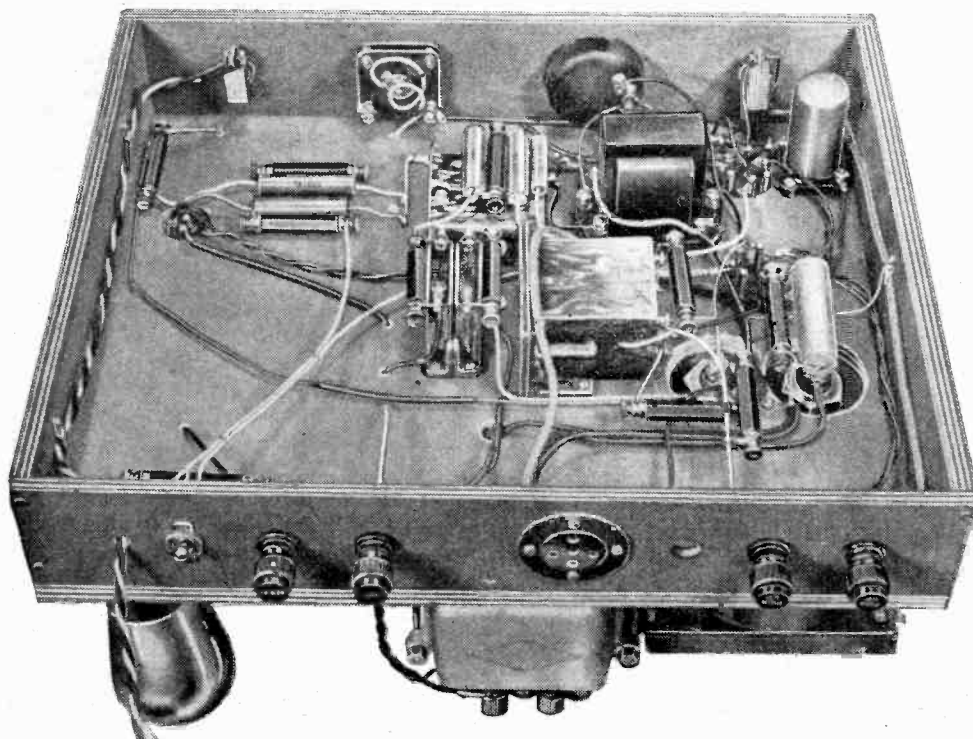

An under-baseboard view of the receiver showing the by-pass condensers and the voltage dropping resistances.

"The Wireless World" A.V.C. Three—

At first glance the arrangement appears somewhat complicated, but it is essentially simple and straightforward in operation, and the rest of the set follows normal practice. The L.F. transformer secondary feeds the control grid of the output pentode, which is of the indirectly heated type rated for an output of about 2½ watts. The cathode is returned to negative H.T. through the 250 ohms bias resistance R14 shunted by the 25 mfd. electrolytic condenser C15; the full H.T. voltage of about

250 volts is thus applied to the output valve. The mains equipment consists of the usual mains transformer with a full-wave rectifier valve and a single smoothing choke Ch3 operating in conjunction with the electrolytic condensers C18 and C17 of 4 mfd. and 8 mfd. respectively.

The three receiver valves are all of the indirectly heated type; in order to avoid an excessive voltage rise on switching on without employing a delay action switch, therefore, the rectifier valve is one of the new indirectly heated types, the MU.12.
(To be concluded.)

- Wood panel, 1 ply, 15in. x 8½in.
- Plymar Baseboard, 12in. x 15in. x ¼in. Peto-Scott
- 2oz. No. 20 tinned copper wire, 6 lengths Systollex, Wire, Wood, Pasolin, Flex, etc.
- Screws: 19 ¼in. No. 4 R/hd., 18 ½in. No. 4 C/sk., 36 ¾in. No. 4 R/hd., 1 6BA 1 in R/hd. with nut and washers.
- Valves:—1 Osram or Marconi MHD4, 1 Osram or Marconi MU12, 1 Mazda AC/Pent., 1 Ferranti VPT4, or Mullard VP4.

The Wireless World
Diary for 1934

THE popular esteem in which previous editions of our Diary has been held was shown by the speed with which the issue has been sold out in past years. It is hoped that the new Diary for 1934 will find equal favour.

Those regular features which experience has shown to be most generally useful have been retained and brought up to date. The list of broadcasting stations in Europe and Northern Africa is given in accordance with the Lucerne Plan, which comes into force on January 15th, 1934.

A new feature which will appeal to all set-users is the Receiver Maintenance Records, in which particulars of battery renewals and technical notes, including valve anode currents, can be recorded.

The Useful Formulæ have been revised, and a new Abac provided for calculating decibels. The Circuit Diagram section has been retained with many new diagrams of receivers and accessories, including a short-wave superheterodyne converter and anti-interference filters and suppressing devices.

The Valve Data section now occupies thirteen pages, and gives the fullest practical information on all the modern valves.

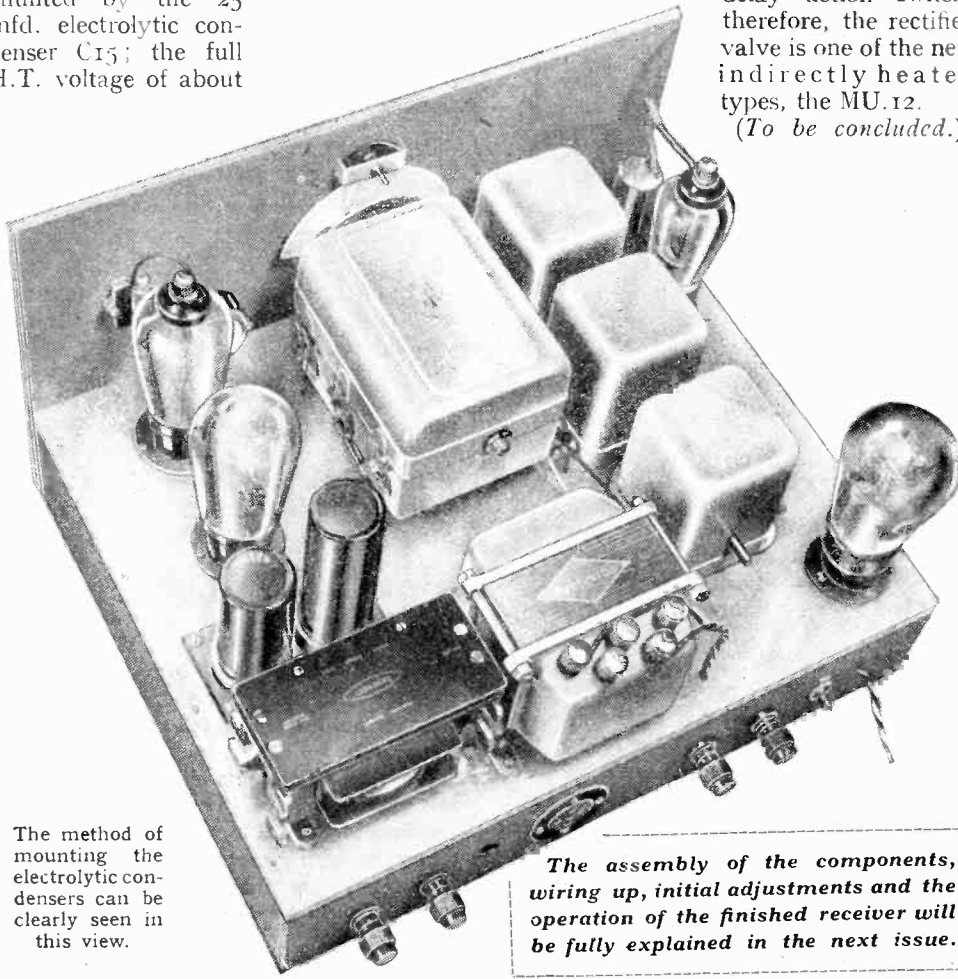

The method of mounting the electrolytic condensers can be clearly seen in this view.

The assembly of the components, wiring up, initial adjustments and the operation of the finished receiver will be fully explained in the next issue.

THE LIST OF PARTS

After the particular make of component used in the original model, suitable alternative products are given in some instances.

- 1 3-gang Variable condenser and disc drive J.B. "Nugang" No. 2064 (British Radiophone, Polar.)
- 1 Variable Condenser, 0.0002 mfd., R.C. Ormond R/507
- 1 Knob for above Ormond R/355
- 1 Iron core coil Wearite "Nucleon" B.P.1
- 1 Iron core coil Wearite "Nucleon" B.P.2
- 1 Iron core coil Wearite "Nucleon" T.C. (Colvern, Varley.)
- 1 Transformer Multitone "Toco" 1:4
- 1 Tone control potentiometer for use with above, R13 Multitone
- 1 Volume control potentiometer, 250,000 ohms. Tapered. R7 Watmel T4 (Claude Lyons, Magnum, Rothermel.)
- 1 H.F. choke, Ch2 Wearite HFP
- 1 H.F. choke, Ch1 Wearite HFPA (Kinva, McMichael.)
- 1 Power smoothing choke, 30 henrys 50 m.a., Ch3 Davenset No. 101 (R.I., Sound Sales, Varley.)
- 1 Mains transformer, 200 to 250 volts, 50 cycles Secondaries: 275-0-275 volts, 4 volts, 2.5 amps centre-tapped, 4 volts 4 amps, centre-tapped. Vortexion A.C.34 (British Radio Gramophone Co., Bryce, Challis, Davenset, Claude Lyons, Sound Sales.)
- 4 5-pin Valve holders Clix Chassis Mounting Air Sprung Type
- 1 7-pin Valve holder Clix Floating Type (W.B.)
- 2 Fixed condensers, 0.0001 mfd., C6, C8 Telsen W.207
- 1 Fixed condenser, 0.0005 mfd., C5 Telsen W.211
- 1 Fixed condenser, 0.25 mfd. 500v. D.C. test, C16 Telsen W.229
- 1 Fixed condenser, 0.05 mfd. 500v. D.C. test, C2 Telsen
- 1 Fixed condenser, 1 mfd. 500v. D.C. test, C10 Telsen W.227
- 2 Fixed condensers, 2 mfd., 500v. D.C. test, C13, C14 Telsen W.226
- 5 Tubular condensers, 0.1 mfd. 1,500v. D.C. test, C3, C4, C7, C9, C11 Telsen W.411
- 2 Tubular condensers, 0.005 mfd. 1,500v. D.C. test, C12, C19 Telsen W.408 (Graham Farish.)
- 1 Dry electrolytic condenser, 4 mfd. 500 working peak voltage C18 Telsen W.396
- 1 Dry electrolytic condenser, 8 mfd. 500 working peak voltage C17 Telsen W.333
- 1 Dry electrolytic condenser, 25 mfd. 25 volts, C15 Telsen W.309 (Dubilier, Peak, T.C.C.)
- 1 Resistance, 200 ohms, R4 Graham Farish Ohmite ½ Watts Type
- 1 Resistance, 250 ohms, R14 ditto
- 1 Resistance, 1,000 ohms, R8 ditto
- 1 Resistance, 2,000 ohms, R5 ditto
- 1 Resistance, 7,000 ohms, R15 ditto
- 2 Resistances, 10,000 ohms, R1, R11 ditto
- 1 Resistance, 17,500 ohms, R2 ditto
- 2 Resistances, 20,000 ohms, R12, R16 ditto
- 1 Resistance, 25,000 ohms, R3 ditto
- 1 Resistance, 100,000 ohms, R9 ditto (Dubilier, Erie, Claude Lyons, Ready Radio, Varley.)
- 1 Grid leak, 2 megohms, R6 Graham Farish Standard Type
- 1 Grid leak, 0.5 megohm, R10 ditto (Dubilier, Erie, Claude Lyons, Ready Radio, Varley.)
- 2 Switches, on-off S1, S3 Claude Lyons 728
- 1 Switch single-pole change-over, S2 Claude Lyons 729 (British Radiophone, Bulgin.)
- 1 5-pin plug Bulgin P.3 (British Radio Gramophone Co.)
- 1 Length screened sleeving Harbros
- 4 Ebonite shrouded terminals, A., E., Pick up (2) Belling-Lee Type B

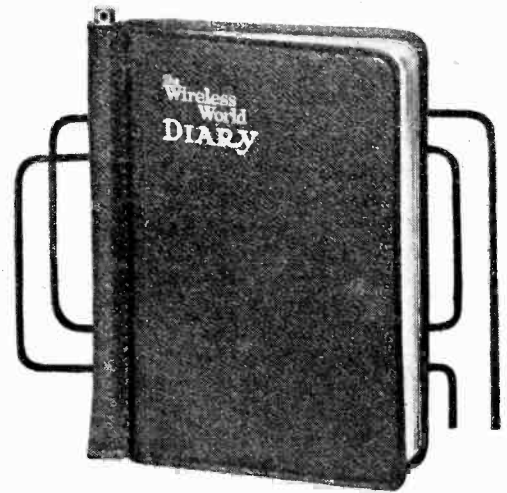

The Diary, comprising 192 pages, is obtainable from all booksellers, stationers, and bookstalls, or direct from the publishers. Price 1s. 6d., or by post 1s. 7d.

THE OLYMPIA CAR DISPLAY

YESTERDAY the great International Automobile Exhibition opened at Olympia. While car radio in this country has as yet made little progress, there is evidence that it is likely to spring into popularity.

In connection with the Exhibition, which closes on the evening of Saturday, the 21st instant, *The Autocar* is producing three Special Show Numbers. The first issue was dated October 6th, and contained a Buyers' Guide to 1934 models, giving full specifications of all cars on the British market. To-day's issue of *The Autocar* is a complete Show Report, and next week various specially interesting features at the Show will be fully described and illustrated.

Television Progress

Problems of the Next Step

IN considering the possibilities of improving radio transmitting conditions, attention has been focused mainly upon what are known as the ultra-short waves, i.e., those below 8 metres, mainly for reasons arising out of experience in connection with facsimile transmissions on the waves around 50 to 100 metres used

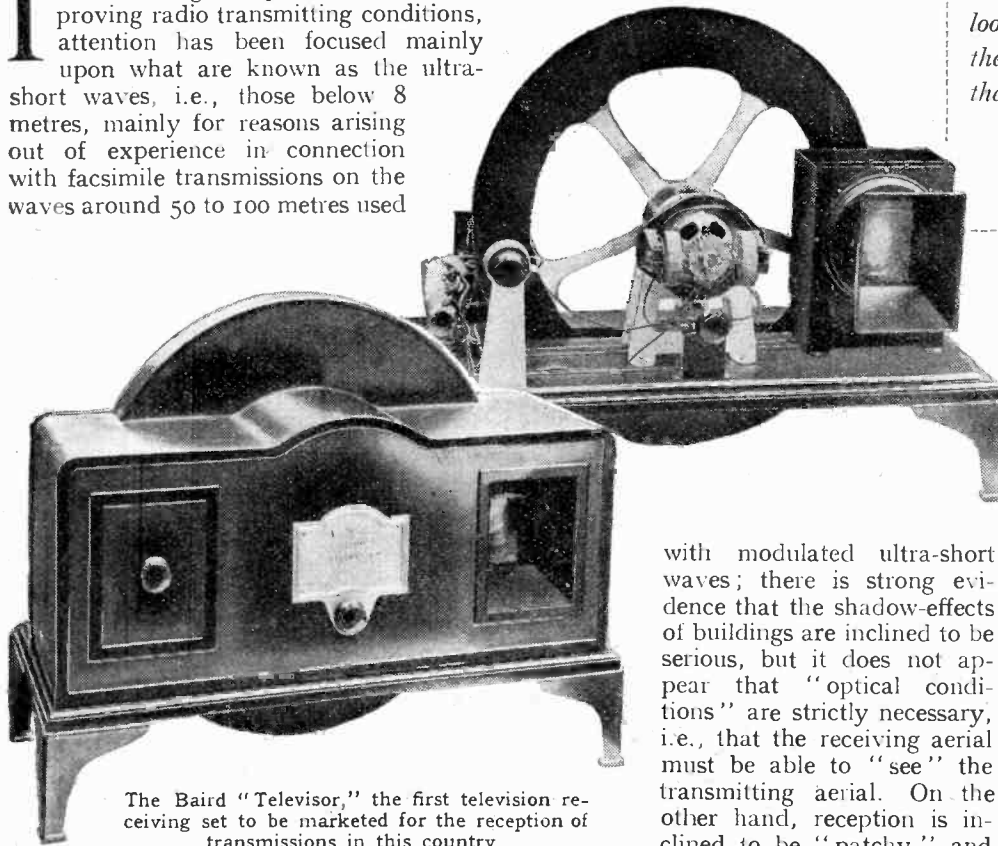

The Baird "Televisor," the first television receiving set to be marketed for the reception of transmissions in this country.

for transcontinental traffic. It is, of course, well known that the latter waves depend for their long-range qualities upon reflections from the Heaviside layer, which, while giving rise to no harmful effects on telegraphic and telephonic circuits, result in confusion of a greater or less degree when visual subject matter is transmitted. Trouble as a consequence of such "echoes" has been experienced in the transmission of facsimile images at relatively low scanning speeds, and it appears to be generally considered that television on these wavelengths would be subject to far greater interference and would thus be impossible in practice.

Wavelength and Service Area

When we come to wavelengths below eight metres we arrive at conditions where reflections from the upper atmosphere do not take place. The result of such a state of affairs is that only a more limited area can be effectively served by one broadcasting station, since the waves attenuate very rapidly as the distance from the station increases, but, on the other hand, there is the advantage that "echo" troubles entirely vanish.

Very little information is available as to the problems of serving a given area

with modulated ultra-short waves; there is strong evidence that the shadow-effects of buildings are inclined to be serious, but it does not appear that "optical conditions" are strictly necessary, i.e., that the receiving aerial must be able to "see" the transmitting aerial. On the other hand, reception is inclined to be "patchy," and it seems fairly clear that the

erection of ultra-short wave aerials in London will not be the simple business to which ordinary broadcast listeners are accustomed in connection with medium and long wavelengths.

The position in connection with improving the detail of the transmitted picture thus resolves itself into the provision (a) of an optical system which subdivides the picture into a greater number of elements, and (b) of an electrical system, including a radio link, which enables the improved detail to be effectively transmitted. The situation under the former heading necessitates a decision as to what degree of detail is essential to good entertainment value, a question which is comparable in one sense to the case of frequency band width in telephonic transmission, but in another sense stands in strong contrast to it. The decision in the case of telephony makes no difference to the design of receivers, as these can perfectly well ignore the extended frequency range if for any reason they do not want to take advantage of it; the decision in the case of television, however, is binding upon all parties, since the receiving apparatus must operate in synchronism with and in exact conformity to the transmitting apparatus.

Of these two problems the second does not require much further consideration,

***B**EFORE we jump to any conclusions in regard to the imminence of a practical television service on short waves, it is well to look at the problems involved and consider the ways and means available for solving them. These problems are discussed in the following article and an attempt is made to give them their proper perspective in the general television picture.*

since the matter of the radio link is perfectly straightforward, though, paradoxically enough, it may prove the most serious stumbling block. We have to design a transmitter which operates on the ultra-short wavelengths, is capable of being modulated over a frequency range of anything up to 500 kc/s with substantially uniform response, and has an aerial system which efficiently distributes the radiated power. On the receiving side an aerial has to be set up which is an efficient collector, having regard to its location, and the received high frequency waves have to be amplified uniformly over whatever range of frequencies is indicated. The most serious problems are field strength and interference, and it must be borne in mind, of course, that the larger the frequency band being received the greater will be the susceptibility of the apparatus to interference, particularly from the ignition systems of motor cars. The purely technical side of building flat amplifiers does not offer insuperable difficulties, though, of course, an unusually large number of stages of amplification may be required.

Short Wave Interference

Having done all that is to be done in these respects, it is a matter of practical experience to discover whether ultra-short wave television broadcasting is or is not possible. The writer's feeling is that a serious campaign to induce motor car manufacturers to put suppressor resistances in their ignition systems will be a necessary prelude to any sort of satisfactory service, and the success of this campaign will be the main condition of success in the whole enterprise.

We now return to the consideration of the former of the two problems, and we are at once faced with the necessity for an important series of decisions which, it must be borne in mind, have to be made for the industry as a whole. We require to settle:—

(a) the number of times the picture is to be scanned per second;

(b) the shape of the picture and the manner in which scanning is to be carried out;

Television Progress—

(c) the number of picture elements that are necessary for adequate detail. According to the present Baird system the picture is scanned $12\frac{1}{2}$ times per second in 30 vertical strips; the shape of the picture is seven (vertical) by three (horizontal), and the number of picture points consequently 2,100.

Service in Germany

As a step in the direction of greater detail, the German Post Office has instituted a regular service of experimental ultra-short wave television transmissions from Witzleben in which the picture is horizontally scanned twenty-five times per second in ninety strips, the shape of the picture is five (vertical) by six (horizontal), and the number of picture points nearly 10,000.

It is advisable to examine more closely the steps by which the German authorities arrived at these figures. In the first place, both the shape of the picture and its rate of repetition are in close conformity with the standards chosen for talking films and enable transmissions to be effected by means of a film provided with scanning machinery. The difference between the picture-frequency chosen and that of twenty-four per second has an important bearing upon the problem of synchronising, since it enables motors to be used at both transmitting and receiving ends which are synchronously driven by simple apparatus from the 50 c/s a.c. mains. Had the picture frequency of twenty-four per second, characteristic of talking pictures, been retained for television purposes it would have been necessary to employ an awkward train of gears if synchronisation were to be effected by means of the 50 c/s mains, and it has evidently been found of no detriment to the results obtained to increase the speed of a talking film in the ratio 25:24 when transmitting it for television purposes.

Apart from the talking film question, considerations of flicker indicate the desirability of an increase in the picture frequency from $12\frac{1}{2}$ per second, unless the effect of persistence of vision can be aided by fluorescence, as in the case of the cathode ray tube, or by some similar effect. The prospect of improved operation along these lines cannot be dismissed, as it is possible to obtain better detail with a slow picture frequency, other things being equal, but the importance of talking film transmission would seem to indicate a higher picture frequency such as that chosen in Germany, in spite of the disadvantages which it may entail.

Synchronising and the "Grid System"

It is perhaps worth while to digress for a short space to consider the synchronising problem in greater detail. Synchronism between transmitter and receiver is an essential feature of any television system and the demands for it are in the highest degree exacting, since we must not only ensure that the picture is stationary, but also that it is "correctly framed," i.e.,

not displaced out of its right position. The latter feature necessitates a consideration of the phase relationship between the two systems; the simplest explanation is again to be found in the "book" analogy, if we consider the transmitter to be "looking" at the first word in a line and the receiver to be "pointing," say, at the middle of the same line. If the receiver is half a line ahead all the way it is clear that the left- and right-hand margins of the book page itself will appear adjacent to each other in the middle of the reproduced version at the receiver, and the original page will be divided down the middle, so that the two divisions appear on either side at the receiving end.

Many devices are known according to which the transmitter sends out a synchronising signal to hold the receiver in step with it, and all of them introduce an element of some complexity, since they require that this signal should be separated from those corresponding to the picture modulations. On the other hand, if both the transmitter and receiver are fed from the same alternating current network, synchronism can be automatically established, subject to the existence of a phasing control which will restore any casual displacement of the picture from its correct position. It is uncertain whether all the

supply broadcast all over the country as a 50 c/s modulation of a radio wave and accurately controlled by a high quality tuning fork or astronomical clock. The frequency band required by this signal would be negligible, and it could be used for direct control of electric clocks or television apparatus, in places where no mains supply was available, and also for regulating the frequency of all sections of the "grid system." It is, of course, unnecessary and undesirable to use an ultra-short wavelength for such a "master wave"; the question as to what wavelength should be employed is an entirely open one, and might be decided simply from the standpoint of what was available for use.

Standard of Detail

Returning to the consideration of the researches of the German Post Office, the main decision, namely, that of the degree of detail required, was arrived at experimentally by the production, using purely optical means, of a series of films having different numbers of "picture points." Horizontal scanning was adopted, i.e., in terms of the "book" analogy, referred to last week, exactly corresponding to an ordinary book. The number

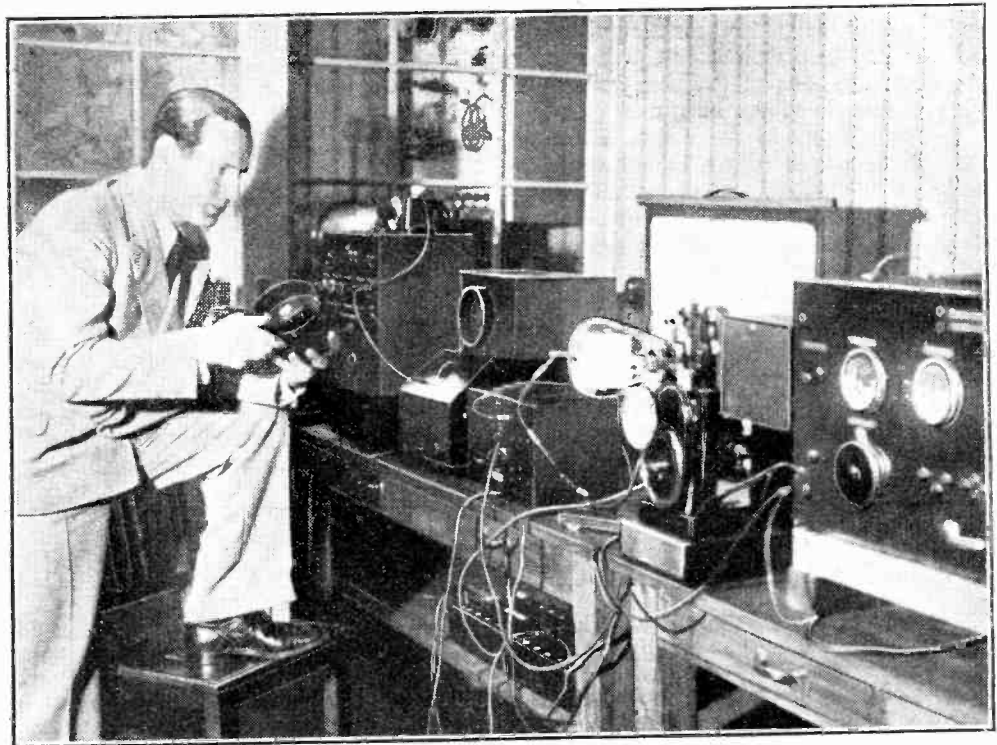

Baron Manfred von Ardenne, an early investigator of television in Germany, and a pioneer of the cathode ray system. In this recent picture he is seen with his latest apparatus employing what is known as the "speed-modulation" system.

alternating current networks in the Central Electricity Board's "grid system" will operate synchronously at all times, but at any rate there is a compelling argument in favour of close regulation owing to the very general use of electric clocks driven synchronously from the mains. Perhaps the slightly greater precision necessary for television purposes might be attained by the provision of a master frequency

of lines was varied in the different films, and the graduation along the lines was made finer in detail as the number of lines was increased, the results being made to conform exactly with what would be obtained in a series of ideal television systems in which scanning was carried out in a manner corresponding to each film.

As would be expected, an improvement in the picture detail was obtained which

Television Progress—

was very marked as the number of lines was increased from 30 upwards, but which became less effective after a certain standard of detail had been achieved. The conclusion was that 90 lines and 10,000 picture points represented a degree of detail which was sufficient for practical purposes, and that a closer analysis only gave a "diminishing return" by way of improvement.

One System or Many ?

From the standpoint of television in this country we have now to consider the question as to whether any standardisation of television transmissions is possible, and, if so, what the nature of the transmissions should be. It is obvious that standardisation is desirable; indeed, it is almost impossible to imagine the alternative situation, where the B.B.C. puts into operation, either in succession or even simultaneously, systems of transmission of a proprietary character designed expressly to work in conjunction with receivers of specific origin. The matter would seem to be one in regard to which the B.B.C. should take great care, since, setting aside the danger of the commercial advantage passing into one set of interests, it is too early to say yet on what lines the future development of television will lie, and it would benefit neither the public nor the industry if a premium were prematurely put upon any one of the many methods of operation that have been advocated.

The alternative to the B.B.C. acting as the only source of transmissions would be for experimental television transmitting licences to be granted by the Postmaster-General to various commercial companies developing television and to amateur experimenters so that the relative merits of a number of schemes could be tried out in practice before the B.B.C. was committed to a service.

There is no doubt that the inauguration of a television broadcasting service on short wavelengths, with increased detail

in whatever measure is considered desirable, would cause an enormous awakening of interest in the whole subject and might, in fact, mark the starting point of industrial developments of the greatest importance. In this situation we look to the Corporation to take the broadest possible view, and, in the light of experience in Germany and elsewhere, and if it sets up,



The Mihaly television receiver shown at the recent Radio Exhibition in Berlin. This system employs a stationary mirror drum, with a rotating reflecting mirror, and an external screen on which the picture is projected. The system was described in the issue of *The Wireless World* of September 15th, 1933.

under its own auspices, a system of transmission it should be one which will allow the fullest possible scope to the endeavours of all sections of the industry. In particular, whatever else is decided, the question of synchronisation should be settled on a basis which is operative for any type of receiver, and in such a manner as to permit the use, wherever possible, of the 50 c/s controlled-frequency mains for synchronous operation.

the medium-wave band. Munich, Vienna, Budapest and Brussels No. 1 never fail to provide entertainment after dusk, and the last-mentioned can be received at any time when it is working. When Brussels goes up to 75 kilowatts the whole of this country should be definitely within its service area.

Brussels No. 2 is also well received, but this is not such a reliable daylight signal. It will also be using 75 kilowatts before long.

Heterodynes have been distinctly troublesome of late, many of the best stations having been affected at times. Luckily, such a thing as a persistent heterodyne night after night on a particular station rarely occurs; it is only now and then that interference is experienced. The choice, anyhow, is so wide nowadays that if one station is suffering there are plenty of others to be had clear of all interference. A programme that is specially attractive can often be received, even if the "parent" station is heterodyned, by tuning in one of the relays.

Specially good stations on the long waves are: Zeesen, Radio Paris, Warsaw and Motala. On the medium-wave band I can recommend Prague, Langenberg, Strasbourg, Heilsberg, Leipzig, Breslau, Katowice, Lyons Doua, Lwow and Beromünster. Fading is beginning to be troublesome below 300 metres for those who have not automatic volume control. D. EXER.

The Radio Industry

"THE Chronicle Wireless Annual," issued by the *Manchester Evening Chronicle*, is now in its eleventh year of publication; the latest edition which has just been issued is an extraordinary good shillingsworth, packed with useful information for wireless amateurs. A number of constructional articles (with large-size wiring plans) are included, and modern developments such as Class "B" and Q.P.P. amplification are treated.

Much space is devoted to the present-day aspects of selectivity and quality, and, in addition, sections of the book are devoted to reference data and lists of stations.

Instructional courses in radio technique, especially prepared for the benefit of the would-be service engineer, are now beginning at the Northern Polytechnic, Holloway, London, N.7. Tuition is both practical and theoretical and full information can be obtained from the Organisers.

Atwater Kent radio products are to be distributed in Great Britain by the Portland Radio Co., Ltd., of 62, Bulsover Street, London, W.1.

Standard Telephones and Cables, Ltd., announce the introduction of an Acoustic Noise Meter. The new instrument is self-contained and portable and is operated by a single dry cell. It is calibrated in decibels.

The Technical and Commercial Radio College, of Lloyds Place, Blackheath, London, S.E.3, are conducting radio correspondence courses dealing with the various aspects of the subject.

The needs of students proposing to enter any branch of the industry are catered for; a descriptive brochure describing the activities of the organisation is available on application.

A new Tungram valve, Type LD 210, has just been produced. This valve is for battery operation and is essentially designed to function as a detector, it being claimed that it is entirely non-microphonic.

A new type of screened valve holder, for Ostar-Ganz valves, similar to that illustrated in our issue of September 22nd, is now being manufactured by Lectrolinx, Ltd., of 79a, Rochester Row, London, S.W.1. The British-made version includes all the well-known features of Clix valve holders.

DISTANT RECEPTION NOTES

THOUGH it is reported that Monte Ceneri is shortly to begin operating on its "Lucerne" wavelength of 257.1 metres, the station is now working again near the bottom of the long-wave band, using a wavelength of about 1,150 metres. It is interfering seriously with Kalundborg and making a nuisance of itself generally.

Other nuisances at the moment are Radio Vitus and Radio Agen. Both are off their proper wavelengths.

The new Lisbon 20-kilowatt station, to whose construction I referred some time ago in these notes, is nearly completed, and tests may begin at any time now. The wavelength will be 282 metres until the Lucerne Plan comes into force, after which the station will go up to 476.9 metres, sharing a wavelength with Skoplje, in Yugoslavia, and Trondheim.

Transatlantic reception continues to be remarkably good, and some of the South

American stations are better heard on certain nights than those in the United States. As readers may have some difficulty in obtaining particulars of South American stations, here is a list of some of the most important in the Argentine and in Mexico:—

	Metres.		Metres.
LS9 Buenos Aires	216	XED Renosa,	
LS8 " "	244	" Mexico	310.9
LS2 " "	252	XEO Mexico City	319
LR8 " "	261	XEW " "	329
LS5 " "	280	LR6 Buenos Aires	330
LR9 " "	291	LR5 " "	361
LR4 " "	303	XER, Villa Acunha	408

Nearly all of these stations use outputs of 10 kilowatts or more, and the great majority have already been received in this country. With a calibrated set stations are not difficult to identify, since announcements are made in Spanish. Be careful, though, not to be misled by small-hours' programmes from Madrid or Barcelona or Valencia!

From European stations very fine reception is now obtainable at the upper end of

Practical HINTS and TIPS

MORE often than not, a gramophone pick-up is connected to the detector valve grid in the manner shown in Fig. 1. A consideration of this diagram will show that, as the volume-control potentiometer setting is varied from maximum to minimum, the value of resistance shunted across the grid circuit is similarly changed.

Testing the Vacuum

It may not have occurred to many readers that, if a milliammeter be connected in series with the anode as shown, we have in this arrangement an effective tester for "softness," or deficient vacuum of the valve.

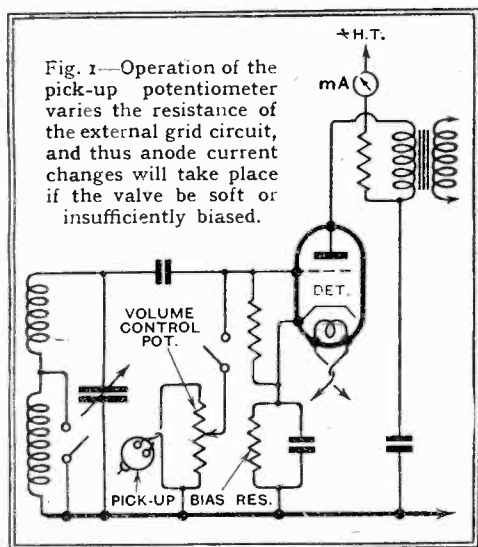

Fig. 1—Operation of the pick-up potentiometer varies the resistance of the external grid circuit, and thus anode current changes will take place if the valve be soft or insufficiently biased.

If any appreciable change in anode current is produced by operation of the volume control potentiometer, it can be assumed that either "positive" or "negative" grid current is flowing. Provided that sufficient negative bias be applied, "positive" grid current cannot flow; accordingly, if operating conditions are correct, any change in anode current is a definite indication of a "soft" valve.

Any valve other than the detector, provided it operates at the same heater or filament voltage, may generally be inserted temporarily in the detector socket for purposes of test.

IT is useful to know that the latest type of combined detector-oscillator valve—the so-called Pentagrid or Heptode—may be tested, so far as the oscillator section is concerned, in much the same way as when a separate valve is employed for the latter function.

Testing Pentagrid Oscillators

To make a definite test, a milliammeter should be joined in series with the oscillator anode, preferably on the low-potential side of the feed resistance. Then, with the aerial disconnected and no signal coming in, the oscillator reaction coil

AIDS TO BETTER RECEPTION

should be short-circuited, and if all is in order a rise in current should take place.

If there be no change in current we have a certain indication of non-oscillation, under which conditions the set cannot possibly function. This test should be carried out on several wavelengths.

In testing the "New Monodial Super" the meter should be connected on the "earthy" side of the resistance R₅, while the experimental short-circuit should be applied between Terminal No. 1 of the oscillator coil assembly and earth.

EVERYONE knows that the effectiveness of an aerial is, apart from the question of height, more or less proportional to its length. But this only holds good if the horizontal span be straight; occasionally one sees indoor aerials which

Indoor Aerials

could be definitely improved by shortening them. For instance, the aerial is sometimes carried round three sides of a room, or even of a narrow hall, the lead-in being taken down from one end; with such an arrangement it is to be expected that the voltage introduced into one side will partially neutralise that in the other, and so the effective length will be actually less than if the aerial were carried along one side of the room.

The design of indoor aerials is hardly susceptible to scientific treatment, but it is always worth while to make a few careful comparative tests before installing a permanent arrangement.

IT sometimes happens that the output from the detector valve is insufficient fully to load the output valve, and so the fitting of an intermediate L.F. stage becomes necessary. As often as not the amplification needed from this stage is

Low-amplification Intermediate Stages

quite small—perhaps not more than four or five times. Provided that an input volume control to the L.F. amplifier be fitted, it does not greatly matter if the intermediate stage be of the conventional high-gain type, giving much greater amplification than is needed. But there is another aspect of the subject that should sometimes be taken into account; the use of excessive magnification tends to increase hum, and to provoke L.F. instability. There is accordingly much to be said in favour of using no more amplification than is strictly necessary; this will often be obtainable from a small power valve coupled by means of a resistance of low value (20,000 ohms or less) to the succeeding output valve.

IT is useful to remember that, from many points of view, the anode circuit of an amplifying valve and the grid circuit of the succeeding valve are identical. With any "one-to-one" coupling, such as choke or resistance, the signal-frequency voltages existing across each circuit are bound to be of almost the same value.

Grid and Anode Circuits

This point may not be immediately apparent from Fig. 2 (a), which represents an ordinary resistance-coupled L.F. stage drawn in the conventional manner. But, by redrawing the amplifier as in diagram (b), it is made clear that anode and grid circuits, linked by a coupling condenser, are in parallel.

All this applies to the H.F. side of the receiver as well as to the L.F. amplifier. The knowledge that these circuits, which appear to be independent, are really in parallel with one another, may often be turned to good account when testing for faults. For instance, when locating hum or intermittent cracklings in a receiver employing the L.F. circuit used as an example, the effect of an experimental short-circuit across either the anode resistance or grid-lead would be almost identi-

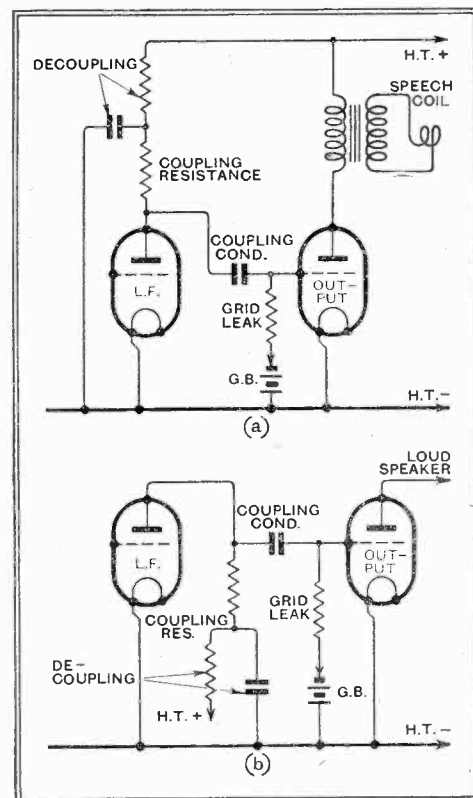

Fig. 2.—The circuit of a conventional resistance-coupled stage is redrawn in diagram (b) to show that grid and anode circuits are in parallel from the signal-frequency point of view.

cal. When one happens to be inaccessible, connection might be made to the other.

Radio Luxembourg

An International Broadcasting Problem

RADIO LUXEMBOURG started some months ago with regular experimental transmissions. These broadcasts are still taking place. To the casual observer they do not bear the mark of "experimental." Luxembourg describes these transmissions as experimental because this station dares not start broadcasting officially on its present wavelength, as this lies in a band reserved for non-public services and can only be used by broadcasting stations after sanction by the countries concerned, and this sanction is lacking. Great Britain has taken a very decided stand against the opening of Radio Luxembourg and also against this station's idea of becoming an international broadcaster. Reasons given are that it would be interfering with the authority of a foreign Government to broadcast, from Luxembourg, programmes addressed to countries outside Luxembourg. Certain Governments in Europe are afraid that a precedent might be created and their carefully built up control of their own broadcasting rendered useless. France and Belgium, on the other hand, are all for the international broadcasting station in Luxembourg, so that when, some time ago, a British protest against Luxembourg was made a few hours later steps were taken by France and Belgium in the opposite direction.

A Finely Equipped Station

The visitor to Radio Luxembourg finds one of Europe's most beautifully laid out broadcasting transmitters working with 200 kW. in the aerial and ample space provided for the addition of a powerful short-wave transmitter. The typical long-wave aerial of the present station still stands, and at the beginning of September there were no signs of any possible changes to adapt the transmitter to the medium wavelength prescribed for it under the Lucerne Plan. In Luxembourg itself a series of beautiful new



MULTI-LINGUAL BROADCASTING.—Léon Moulin, the Luxembourg patois announcer, sharing the microphone with Eva Siewert, who announces in German.

studios have just been completed. Plans are prepared for the building of a large concert hall to act as a studio as well, and a small orchestra has been engaged. There are permanent announcers for French and German and for the Luxembourg patois, and occasional announcers for Italian, Spanish, Dutch, and English. Luxembourg broad-

AN AIR OF PERMANENCY attaches to this view of the massive main entrance door to the Luxembourg transmitter building. Note the design, which suggests that Luxembourg will encircle the world with its new short-wave transmitter.

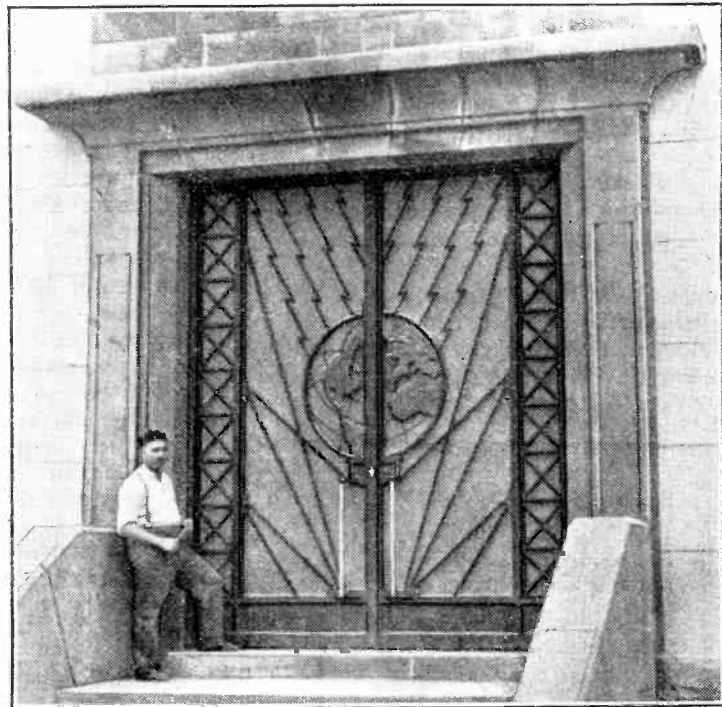

casting programmes are arranged for a different country each evening. The idea is that Luxembourg, once it has received international sanction, should start broadcasting sponsored programmes for various European countries. In Germany a company was formed some time ago, with the co-operation of the German Post Office and of the semi-official Wolff News Agency, to act as official agent for the selling of Luxembourg "air space" in Germany.

The answer to "What will happen to Luxembourg after January 15th?" is intimately related to the question, "Will the Lucerne Plan come into force on that day?" At the present moment Holland, Sweden, Lithuania, Finland, Poland, Hungary, Greece, and Luxembourg have not adhered to the Lucerne conditions. It is generally understood that attempts are being made during the meeting of the International Union of Broadcasters, which is taking place during this week at Amsterdam (at the invitation of the Dutch broadcasters), to bring these countries into line. This seems a very difficult problem at the present moment, as the main bone of contention is the long waves.

Where the U.I.R. is Powerless

We are inclined to attach much importance to the Union Internationale de Radio-diffusion, but this body is the official expert to the International Union of the Postal Administrations of Europe in all matters regarding broadcasting, and no more. There are even members of the Broadcasters' Union who at one time hoped that they would have authority to arbitrate in cases where any broadcasting station might start direct propaganda against the existing Government in a neighbouring country. These hopes have long since been shattered, and it is therefore excusable to ask why the International Broadcasting Union should pass a resolution against Luxembourg whilst no such action is taken against larger countries which are similarly offending.

At the Amsterdam meeting the U.I.R. has, in its technical committee, had to discuss ways and means of putting the Lucerne

Plan into practice. The committee dealing with legal aspects is, no doubt, studying the problem of what will happen if the Lucerne Plan is not signed by the eight outstanding countries. Their deliberations may bring us closer to a solution of the wavelength problem and international broadcasting as exemplified by Luxembourg, but whether they can tackle political and unfriendly broadcasting is another matter.

I understand that most European postal administrations sent non-participating representation to Amsterdam, as they did not wish that Lucerne should have the same fate as the North and Central American wavelength conference, which has just failed to reach an agreement.

"WANDERING WAVE."

BLUE PRINTS

For the convenience of constructors full-sized blue prints are available of the following popular *Wireless World* sets that have been recently described, price 1s. 6d., post free.

Short Wave Two. (November 4th and December 23rd, 1932.)

Monodial D.C. Super. (December 2nd and 9th, 1932.)

Straight Three. (December 16th, 1932.)

Modern D.C. Three. (December 30th, 1932, and January 6th, 1933.)

All-wave Monodial Super. (January 27th and February 10th, 1933.)

Modern A.C. Quality Amplifier. (February 17th, 1933.)

Ferrocart III. (February 24th and March 3rd, 1933.)

The Class "B" Ferrocart Receiver. (April 17th, 1933.)

Universal A.C. Short-wave Converter. (April 28th, 1933.)

New Monodial [Super.] (July 21st and 28th, 1933.)

Modern Battery Four. (August 11th, 1933.)

D.C. Superhet. (September 29th, and October 6th, 1933.)

These can be obtained from the Publishers, Iliffe & Sons Ltd., Dorset House, Stamford Street, London, S.E.1.

Visual Tuning Indicator

Practical Notes on the Micromesh "Tunograph"

THE tuning of a receiver fitted with A.V.C. is apt to be more difficult than that of a set not so equipped, for the automatic volume control appears to flatten the tuning, and a precise setting for optimum signal strength cannot readily be distinguished. It is the usual practice, therefore, to tune a receiver of this type for minimum background hiss, or for the best quality of reproduction, instead of for maximum signal strength. There is no real difficulty in this, once the operation has become familiar, and after a little practice it is quite possible to tune as accurately as with the aid of an indicator.

There is no doubt, however, that a visual tuning indicator is a help, particularly when the receiver is to be handled by unskilled members of the family. Various methods of visual tuning are possible, but methods depending upon the movement of a light or a shadow are probably the most popular. The Micromesh "Tunograph" comes under the former of these headings, for the position of a spot of light on a screen is made to vary with the strength of the signal.

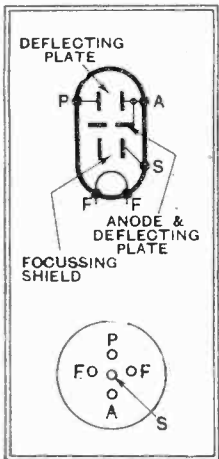

Fig. 1.—The electrode arrangement and base connections of the "Tunograph."

The beam of electrons passes through an opening in the anode and then between the deflecting plates until it finally strikes a fluorescent screen mounted at the upper end of the bulb. One focussing plate is connected internally to the anode, and the other is available for external connection. If both are maintained at the same potential, the beam of electrons strikes the screen at the extreme right-hand side, with the tube mounted vertically, and gives the characteristic green spot of a cathode-ray tube.

If the free focussing plate be now biased negatively with respect to the other, the spot of light moves towards the left by an amount which depends upon the bias, and some 40 volts is needed to bring it to the extreme left-hand side of the screen. In practice, therefore, the change

of anode current with grid bias on a controlled valve is made to deflect the spot of light, and, since the change of current increases with signal strength, the deflection of the spot is greatest for a strong signal.

The indicator is not confined to an arrangement of this nature, however, for, being practically free from inertia, the electron beam can follow the alternating signal potentials. If the deflecting plates be maintained at the same steady potential, therefore, in the absence of a signal, the spot of light will appear at the right-hand side of the screen. The application of signal potentials between the plates will then cause the spot of light to vibrate backwards and forwards in a straight line, with the visible result of a line of light the length of which is dependent upon the strength of the applied signal.

Line Indication

The circuit connections for this arrangement are shown in Fig. 2, and it will be seen that the "Tunograph" is connected across the last tuned circuit of the receiver. Since the tube has a certain capacity, this circuit will require retrimming after fitting the indicator, but this should present little difficulty. It will be found that the line of light spreads to the left with increasing signal strength, and tuning is carried out for maximum length of line.

This method of indication, while very



The "Tunograph" indicator, showing the light spot on the screen. As the tuning is varied to bring the set into resonance with the signal, the light spot moves to the right.

attractive from some points of view, is open to two objections in practice. In the first place, a very strong signal is necessary to give any decided line, about

13 volts for a length of 1 cm., and very few receivers are designed to operate with a detector input greater than one-tenth of this. Secondly, there is a reduction in visibility when the spot spreads out into a line, and on a very strong signal the line itself may be barely visible, and it is possible to see only a faint line with a blob at each end.

Spot Tuning

For general use, therefore, the alternative circuit, Fig. 3, is preferable, although

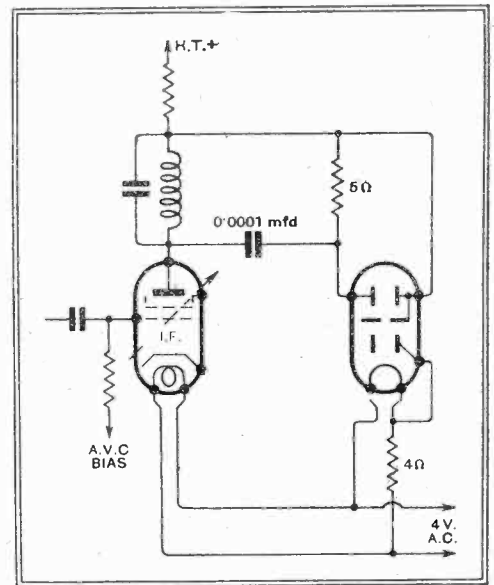

Fig. 2.—The connections for a line indication are shown here, and it will be observed that the "Tunograph" is fed from the last H.F. or I.F. tuned circuit.

this necessitates slightly more alteration to the set. A resistance of some 10,000 ohms must be included in the anode circuit of one of the controlled valves. The anode of the "Tunograph" is connected to the positive H.T. side of this, and the free deflecting plate to the other. Assuming an anode current with no signal of 4 mA., the free deflecting plate is then biased negatively with respect to the other plate by 40 volts, so that the spot of light comes to rest at the extreme left-hand side of the screen. When a signal is tuned in, and A.V.C. comes into action, the anode current of the controlled valve drops by an amount which is dependent upon the signal strength, with the result that the voltage drop across the 10,000 ohms resistance falls proportionately, and the free deflecting plate becomes less negatively biased, so that the spot of light moves to the right. Tuning, therefore, is carried out for a maximum movement of the spot of light.

The disadvantage of this method, when the tube is to be fitted to an existing set, is that the necessity for including a re-

Visual Tuning Indicator—

sistance in the controlled valve anode circuit means that its anode voltage is reduced. The value of 10,000/20,000 ohms marked on the circuit diagram is suggested by the makers; it will, however, obviously depend upon the type of valve used. Since, with no signal, a voltage drop across it of 40 volts is required, 10,000 ohms is correct for a valve taking 4 mA., and 20,000 ohms for one taking 2 mA. Some variable- μ valves, however, require 8 mA., and then the requirements are met by a resistance of 5,000 ohms. In practice, the resistance value is best determined by selecting a value such that with no signal the spot of light settles at the extreme left of the screen. When adding the indicator to a set, it will probably be best included in the anode circuit of the earliest controlled valve, for the reduction of 40 volts in its H.T. supply will probably be least felt here.

The anode potential of the "Tunograph" must be at least 180 volts, and care should be taken to see that the mains transformer is capable of supplying an additional ampere of current for the filament without an excessive drop in heater voltage on the valves. Since the filament

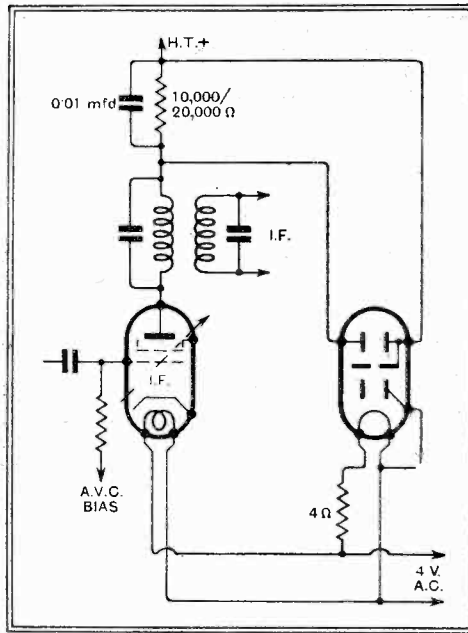

Fig. 3.—With these connections, the position of the light spot varies with the bias on the controlled valve, and hence with signal strength.

of the indicator is rated for only 0.5/0.6 volt, it must be run from the 4-volts A.C.

lines through a 4-ohms resistance rated to carry one ampere.

It should be noted that the spot of light is not readily visible in a bright light unless the tube be enclosed in a light-proof box with a viewing window. It is suggested that the tube be mounted inside the cabinet in any convenient position and a small hole cut in a suitable position on the panel for viewing. In general, it will be best to mount the tube horizontally, with the left-hand side of the plate at the bottom when using a spot indication, and the right-hand side at the bottom when using a line indication, for the spot or line will then move vertically on tuning in a signal, and the operation of tuning will be carried out for maximum height of spot or line.

It should be pointed out that the spot can be deflected by external magnetic or electrostatic fields, and a small deflection will be observed on touching the glass bulb with the finger, due to the dissipation of the charge which accumulates on the glass. It is not improbable, therefore, that the spot might move right off the screen if the tube be mounted in close proximity to a loud speaker, mains transformer, or smoothing choke.

News of the Week

Despite the Depression

NEW ZEALAND receiving licences have now reached the 100,000 mark.

An Acoustic "Find"

VIENNA'S finest studio from an acoustical point of view is the small hall of the Municipal Concert Building. This has been hired by the broadcasting company for use at frequent intervals for important musical programmes.

Medium Wave Freaks

AMONG letters reporting reception received by the Brussels broadcasting stations have been reports from members of the New Zealand DX Club. It is also interesting to note that Athlone has been picked up by the same club.

Good News for Dealers

WIRELESS dealers need have no scruples in giving public demonstrations on loud speakers, despite the decision of the Court of Appeal that the public reproduction of broadcast music is an infringement of the composer's copyright. In a statement made last week, Mr. C. F. James, General Manager of the Performing Rights Society, said that the Society did not contemplate any departure from the policy hitherto followed in the matter of performances given in dealers' shops solely for the purpose of demonstrating wireless apparatus with a view to sale.

These performances, said Mr. James, were "public" for the purpose of the Copyright Act, but the Society had never concerned itself with cases of this kind and did not propose to do so now.

Current Events in Brief Review

Changes at Munich

THE Munich high-power transmitter is to close down temporarily for constructional changes made necessary by the adoption of a new wavelength and an increase in power from 60 to 100 kW. Until January 15th next the old Munich 1.5 kW. transmitter at Stadelheim will be used.

No Pompous Oratory

ACCORDING to an interview given by M. Laurant-Eynac, the French Postmaster-General, politics will be absent in the new French broadcasting scheme.

"Polemics are out of place," said the P.M.G., "in programmes intended for the world; we shall seek a broadcasting style without pompous oratory."

Merciless war will be waged on man-made static, and by the end of November anti-interference devices will become compulsory.

Graceful Tribute from U.S.

"Q.S.T." the American amateur journal, is high in its praises of the experimenters, Messrs. O'Heffernan and Myatt, who secured the world's record for ultra-short wave communication when the former transmitted from the top of Snowdon in August last, and was heard at Hoddesdon on a *Wireless World* "Ultra S.W. Two," 200 miles away.

"If any U.S. amateur has done comparable DX from such an altitude," says "Q.S.T.," "we have yet to hear about it. Even our honest-to-goodness mountaineers have yet to notice such things happening around them."

Stage v. Studio

THE traditional warfare between broadcasting and the theatre assumes a new complexion with the news from Prague of an enterprising theatrical manager there, who, hearing an unusually good bass broadcasting from Warsaw, "stole" him for the purpose of his next production.

Tokio Listeners Aid Air Force

BROADCAST listeners were asked to participate in the recent aerial manoeuvres at Tokio. They were formally requested to intercept the planes' signals on their loud speakers as the squadrons passed overhead and to convey these messages "by all possible means" to headquarters.

Slower Wireless Waves?

TESTS on the actual speed of wireless waves have just been completed by MM. Stoyko and Jouanist, of the Paris Academy of Science. Despite the theoretical assumption that the wireless wave, having the same speed as that of light, travels at a rate of 300,000 km./sec., the French scientists have discovered that short waves travelling between Buenos Aires and Paris have a speed of only 270,000 km./sec. The difference of ten per cent between the theoretical and practical values may be explained by the number of reflections which the waves undergo, which would tend to lengthen the distance covered and slow down the wave. Long waves, the scientists state, travel at the speed of only 245,000 km./sec.

The Three Best

DURING the past year Belgium has registered the third highest percentage amount of listeners to density of population, her figure of 69.3 per thousand being exceeded only by Spain (108.3) and Greece (72.3). There are now in Belgium 409,000 French and Flemish-speaking listeners.

Superhet as "Also Ran"

THE Copenhagen Radio Exhibition opened with a startling declaration by the Danish Premier, M. Stauning, that the Lucerne Conference had been a failure.

As to the exhibition itself, our Danish correspondent reports that the superheterodyne receiver was not nearly so popular in Northern Europe as it appears to be in the south. Straight receivers were much in evidence, the most popular being three- and four-valve arrangements. Many British sets and components were displayed.

Banning the "Gyp"

ONE of the by-products of America's National Recovery movement will be the elimination of the so-called "Gyp" radio service men, and those who will take their place are being organised to outlaw "the vulturous class" with which the radio service field is infested.

Among the unfair practices the new code will ban are: Stealing good radio valves and replacing them with damaged ones; malicious destruction of equipment under inspection to create additional work or justify charges; use of radio service as a pretext for gaining entry into a home for illegitimate purposes; charging for services not rendered; and, finally, misrepresentation of ability.

BROADCAST BRIEVITIES

By Our Special Correspondent

Private Line

THE private telephone line between Broadcasting House and the H.M.V. studio at St. John's Wood has proved very useful of late, not only for the preparation of records of B.B.C. studio performances and recitals on the Concert Hall organ, but in the making of the new form of "trailer" which Mr. Val Gielgud resorted to in presenting his talk on "Radio Drama" the other day.

The Radio "Trailer"

Mr. Gielgud was copying film methods when he gave us a vivid minute taken from a forthcoming radio thriller; in other words, he gave us a trailer, as the film folks call such episodes, which was actually recorded by H.M.V. and broadcast from the gramophone record specially for the occasion.

The episode was acted at Broadcasting House and was recorded over the H.M.V. land line.

Droitwich Testing Next Spring

THE mast riggers' strike notwithstanding, the B.B.C. hope to have the Droitwich transmitter testing next spring. It has now been decided that the two 700ft. masts shall sustain a single "T" aerial.

The Post Office Will Oblige

As I predicted a few weeks ago, the available power will be far in excess of the nominal 100 kW., though this is the maximum for which the station will be licensed. However, as is known by those who have had any dealings with the General Post Office headquarters staff, these officials can be very accommodating in matters of this kind, and I do not doubt that, if circumstances require it, the B.B.C. will be granted permission to use a greater aerial output.

A power of 100 kW. will seem small next year if the present plans of many of the European stations come to maturity.

Good-bye to "No. 10"

IT is now fairly definite that the New Year will see the closing down of the Wharf Studio, "No. 10." The alterations to Waterloo Bridge will involve so much noise that the programmes are likely to be interfered with; moreover, there are other reasons to bring about the B.B.C.'s departure.

Skating Rink?

In all likelihood the Corporation will then resort to the skating rink in Delaware Road, Maida Vale, to which first reference was made in these columns on September 1st last, when an exclusive photograph of the suggested building was published. There is, however, a remote possibility that the B.B.C. authorities may use the H.M.V. studio at St. John's Wood for the now famous "Music Hall" programmes, and they also have their eyes, I am told, on the Small Queen's Hall. But the odds are in favour of the skating rink.

Trafalgar Day

NINE scenes and forty speaking parts are comprised in a forty-five minutes' broadcast on October 21st in celebration of Trafalgar Day. The programme is drawn from "The Dynasts" by Thomas Hardy, and one scene is set in the cockpit of the *Victory*, where Nelson died.

For Quality Lovers

IF a ballot were held to decide which is the favourite B.B.C. orchestral combination, I believe that the B.B.C. Theatre Orchestra would win a high place, especially among those listeners who concentrate on quality reproduction. For there is no gainsaying the fact that it is these smaller orchestras that are heard to the best advantage under modern receiving conditions.

What We Hear

The Theatre Orchestra is now undergoing reorganisation under the direction of Mr.

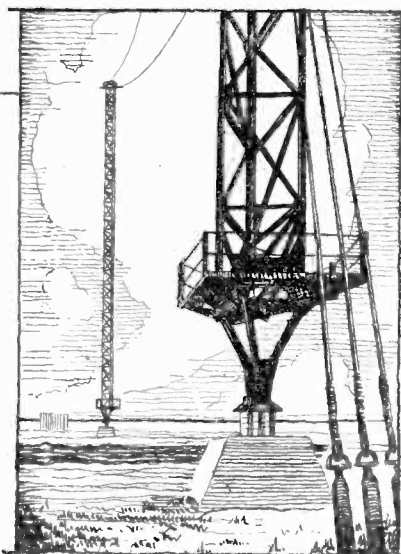

Stanford Robinson. As it is always interesting to know just what instruments are being broadcast, I append a list showing the composition of the reconstructed orchestra.

Six first violins,	One bassoon,
Two second violins,	Two horns,
Two violas,	Two trumpets,
Two 'cellos,	One tenor trombone,
One double bass,	One bass trombone,
Two flutes,	One tympani,
One oboe,	One percussion.
Two clarinets,	

"Kaleidoscope" Revived

ONE of the most haunting plays ever broadcast was "Kaleidoscope," representing the life of a man from the cradle to the grave. First heard five years ago, this play was a brilliant example of the fertile imagination of the author, Lance Sieveking. It was the earliest play of its type, and it is only fitting that it should figure in the festival of radio drama now running.

Listeners to the National programme will hear the revival on October 27th, and it will be heard by Regional listeners on the following evening.

Synchronisation Phenomena

IT is now just possible when listening in certain of the outlying areas to observe the effects of synchronisation between West National and London National. Listeners have written to the B.B.C. complaining of "wavering" on sustained notes similar to that occurring on a swinging gramophone record, this beat note being caused by minute phase variations.

But considering that, according to the B.B.C., only three listeners have complained on this point, it might be premature to describe the experiment as a failure. However, the engineers, with the cautiousness of their tribe, declare that the trouble may be more pronounced with the approach of winter.

Wales Changes Her Tune

Taken as a whole, West Regional station seems to be giving great satisfaction—100 great, in fact, in South Wales, where many listeners report that they are swamped by the two transmitters.

This has its amusing side when one remembers the pother which arose in Wales when it was decided that West Regional should occupy a site on the other side of the Bristol Channel. Wales scented neglect on the part of the B.B.C., but that particular form of grouse seems to have died the death.



RADIO CITY, NEW YORK, is equipped with this special Air Controlling Plant, whereby the ventilation of each studio can be checked at any moment and changed to suit requirements. There are 64 dials. It is stated that four generators in the basement can produce "900 tons of refrigeration in 24 hours."

Letters to the Editor:—

Double-channel Transmission

Electricity Charges; Valves or Stages; Aerial Overhaul

The Editor does not hold himself responsible for the opinions of his correspondents

Double-channel Transmission

IT may be of interest to know of some experiments which I have conducted in connection with Double-Channel Transmission or Binaural listening. Using two non-directional microphones 6in. apart, the currents were taken through separate amplifiers to "A" type Brown's earpieces. A switch was provided so that the two channels could be put in parallel. The increased spread of the orchestra when listening binaurally gave an effect very similar to that experienced when the frequency scale of the reproducing system was increased, the separation of the instruments being much greater. Binaural listening was undoubtedly much more realistic than when using a single channel. In order to ascertain whether it was necessary for the two channels to have identical frequency response curves, one of the Brown's earpieces was replaced by a cheap earpiece of the large iron diaphragm type having a very low natural resonance. Although the resulting frequency characteristic of the two channels were totally different, the advantage of binaural listening was still retained.

With regard to binaural listening through loud speakers, this presents a fundamental difficulty, inasmuch as for true binaural listening, the sounds which reach each ear have to be kept distinct and separate. Any loud speaker arrangement, except possibly one in which a loud speaker is fixed on each side of the listener's armchair, will have the disadvantage that the sounds from each speaker will reach both ears with comparable strength. Even in this case, the time lag if the listener's head is not central may spoil the effect, but I have not tested this question.

It would seem that the only practical way of imitating binaural listening with loud speakers is an arrangement where several microphones are spaced at considerable distances, and the reproducing loud speakers spaced in a similar manner. This arrangement will repeat at the listener's ear, more or less, the effect of the physical dimensions of the orchestra. It would be essential, however, for the loud speakers to be placed farther apart than would be possible if they were both included in a cabinet of the ordinary size.

P. G. A. H. VOIGT.

Upper Norwood, S.E.

Wireless Sets and Electricity Charges

WITH reference to your description as "audacious" the Mexborough notice printed on page 204 of your issue of September 1st, I consider that you are being unreasonable in your demand that wireless sets should be supplied at the domestic heating and cooking rate.

A typical scale of rates of charges is:—
Lighting, 5d.

Power, 3½d. for first 500 units.

After-hour shop lighting, 2d.

Domestic cooking and heating, 1½d. for first 200 units.

Water heating, ½d. (cut off during peak load).

You might as well demand to couple wireless sets to the water-heating meter!

Probably 50 per cent. or more of supply authorities have, as a considered policy, a different scale for power from that for domestic heating and cooking.

A house using 600 units a quarter for heating and cooking would, on the sliding scale, get such current for 1d. a unit, whereas a factory would have to use 40,000 units per quarter on the power sliding scale to get down to 1d. a unit. Such seeming inequality can be strongly defended.

The basis for these different rates, depending on the filling up of "troughs" in the load line and the general raising of both load line and load factor, is a complicated business into which there is no occasion to go here, as the general principle remains established and sound economically.

By the majority of supply authorities it is stipulated that the domestic cooking and heating rate is not applicable to domestic power, e.g., a motor for pumping from the house's own well, or for working a lathe,

from the power (or lighting) supply, and not from the heating, notwithstanding that an electric fire may be employed as the dropping resistance.

Is not your attitude—which apparently is not fully supported by the electrical Press—based on your incorrect conception of "power" wiring in private houses, whereas such wiring, other than the lighting wiring, is nearly always "heating or cooking" wiring?

That the power used in wireless sets heats the cathodes is no more relevant than the fact that a motor is heated by its current.

I agree with you to the extent that wireless sets and clocks should be supplied at power rates if the owner is agreeable to be so separately metered and to be charged the appropriate meter rent and minimum charges, but I think most would find it cheaper to revert to being charged at lighting rates, as in the cases of householders who only use an iron for an hour a week.

Anomalies are bound to crop up in detail of electrical charging, as electricity cannot be stored to the same degree as gas or water, and many lighting consumers are unable to grasp why they should pay more than the power scale. On these matters discussion might be interminable before conviction.

Staffordshire.

COLONEL.

Valves or Stages?

WE must agree, on reading the letter from Ferranti, Ltd., that neither by valves nor stages can we satisfactorily describe a receiving set, seeing that we have passed the time when each valve is a general-purpose valve with the same characteristics.

It seems to me that the abilities of a set are best described by giving first the maximum possible amplification (allowing, say, 5 per cent. distortion) expressed as a ratio between aerial input and L.F. output, and, secondly, the output in watts of the last stage.

Other facts, such as consumption, frequency range, whether volume automatically controlled and so on, would also be added, of course, and amongst them could be given the number of valves and their type.

Ipswich.

PENSEMULO.

Importance of Aerial Overhaul

THE importance of aerial overhaul to which you have drawn attention in recent issues cannot be too strongly stressed.

I made the following experiment some time back: On test, an aerial showed a reading of 2 megohms at 500v. D.C. The insulators were cleaned with carbon tetrachloride, the liquid was then filtered through a one inch square of blotting paper. The paper was then heat dried to expel any moisture, and a test made from two opposite corners. The result was a dead short.

If properly erected an aerial should give a reading of infinity, and this insulation can be made to hold good even in a storm of rain.

J. P. J. CHAPMAN.

Bournemouth.

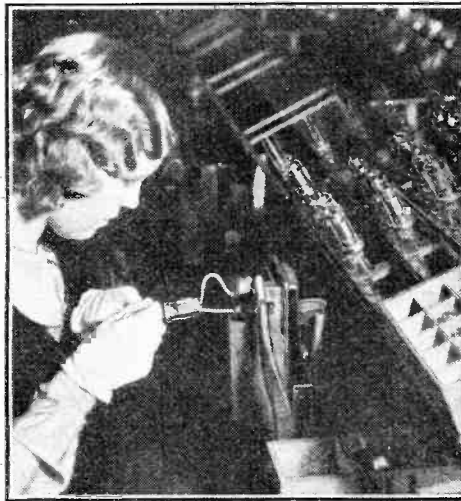

A spot-welding process in the manufacture of the new Cossor DD/PEN valve.

saw, etc., for which purpose the householder has the option of demanding a separate power meter, using separate internal wiring. With the high rate for a small quantity of power, coupled with a fixed half-yearly minimum charge and capital outlay on wiring, it would often pay the consumer to take such power through his lighting meter.

Strictly, in such cases, a vacuum cleaner, sewing machine motor, etc., should be charged at power rate, but many authorities might condone, though not approve, such small current-consuming devices being served from a heating plug.

In the same way the charging of accumulators for car or wireless purposes must be

Correspondence, which should be as brief as possible, should be addressed to the Editor, "The Wireless World," Dorset House, Stamford Street, S.E.1, and must be accompanied by the writer's name and address

Ferranti "Lancastria" Superhet

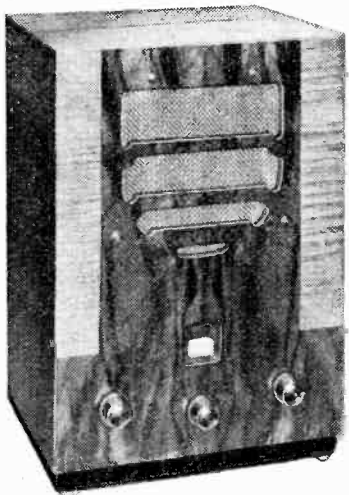

FEATURES. Type:—Self-contained table model superheterodyne receiver designed to work from A.C. mains on an external aerial. **Circuit:**—Detector oscillator with band pass input and image rejector circuit—I.F. amplifier—second detector (diode triode)—triode output valve. **Controls:**—(1) Tuning with illuminated wavelength scale. (2) Volume Control. (3) Wave-range and on-off switch. **Price:**—15 guineas. **Makers:**—Ferranti, Ltd., Hollinwood, Lancs.

A Compact Receiver with Excellent Volume and Range.

ALTHOUGH the overall dimensions of this set are only 15½ in. × 10½ in. × 9 in., it is anything but a "midget" set in performance. With an energised moving-coil loud speaker and a power valve capable of an undistorted output of 2½ watts, the volume and quality would do credit to a small console radio-gramophone. The fullness of the bass response is particularly impressive for a cabinet of such small size, but there is no undue suggestion of resonance in this region. If reasonable care is taken in tuning, a very satisfying balance of tone is obtained over the frequency range, which extends well into the upper register.

The receiver is a four-valve superheterodyne, and the components have been designed and assembled with unusual skill, so that, although the overall dimensions of the chassis are small, there is no evidence that anything has been skimped.

The chassis as a whole is mounted on sponge rubber blocks to minimise mitro-phonous noise, and special care has been taken to ensure immunity from electric shocks. The valves at the back of the cabinet are enclosed in cylindrical screens, to which access is obtained only after removing the channel-section cover plate.

There are three controls, the one in the centre operating the illuminated wavelength scale, that on the left combining the wave-range and on-off switch, and the one on the right the volume control. The sensitivity of the set is such that it is rarely necessary to make full use of the latter control, and Langenberg in daylight can be brought up to full loud-speaker volume with

the control set at a little more than the half-way position. The wave-range control knob does not carry any indication marks,

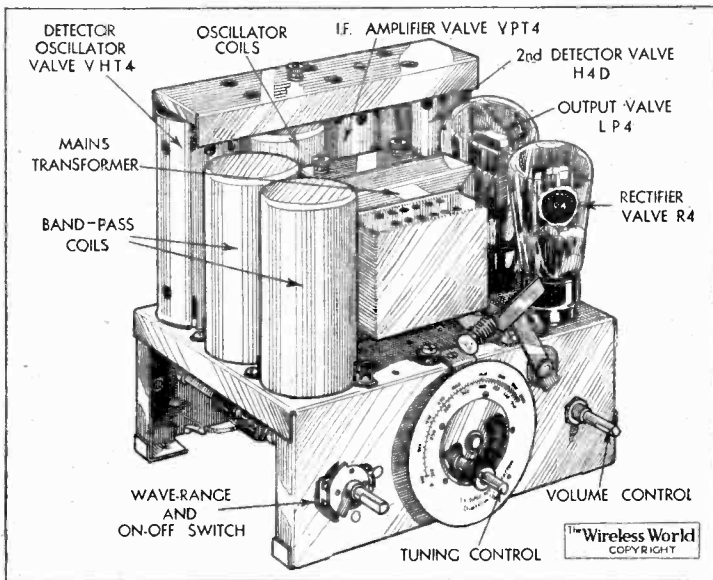

The "Lancastria" chassis is a model of compact design.

neither has switching for the gramophone pick-up been included, and the necessary change in the circuit must be made by removing the tag from the pick-up terminals at the back of the set.

The selectivity is remarkably good for a set of this type, and in Central London it should be possible to receive stations on

the channels adjacent to the London National transmitter. Owing to the slightly higher signal strength of London Regional, it was barely possible to obtain adjacent channel selectivity, but there can be no doubt that an increase of distance of five miles or so from the station should bring this feat within the capabilities of the set.

The selectivity on long waves is equally good, and the reception on this range is notable for the absence of background noise.

There is very little interference due to second-channel whistles, and the only one which could be traced was in the neighbourhood of 500 metres and did not coincide with any important station. A special balancing circuit has been included in the input band pass filter to neutralise this type of interference.

The first valve in the circuit is the Ferranti-type VHT4 "heptode," which combines the functions of oscillator and first detector. It is followed by an intermediate frequency amplifying stage which includes four tuned circuits. The output from this stage is rectified and amplified by the Type H4D double diode triode, the two electrodes of the rectifier being bonded together, as automatic volume control is not included in the specification. Resistance coupling is used between this valve and the Type LP4 triode output valve which, as mentioned above, is designed to give an output of 2½ watts.

The power supply circuit follows normal practice, and the smoothing is efficient.

This is a receiver which clearly demonstrates that a high standard of performance does not presuppose a cabinet of bulky proportions, and it will go far to remove the prejudice which exists in some quarters against so-called "midget" sets.

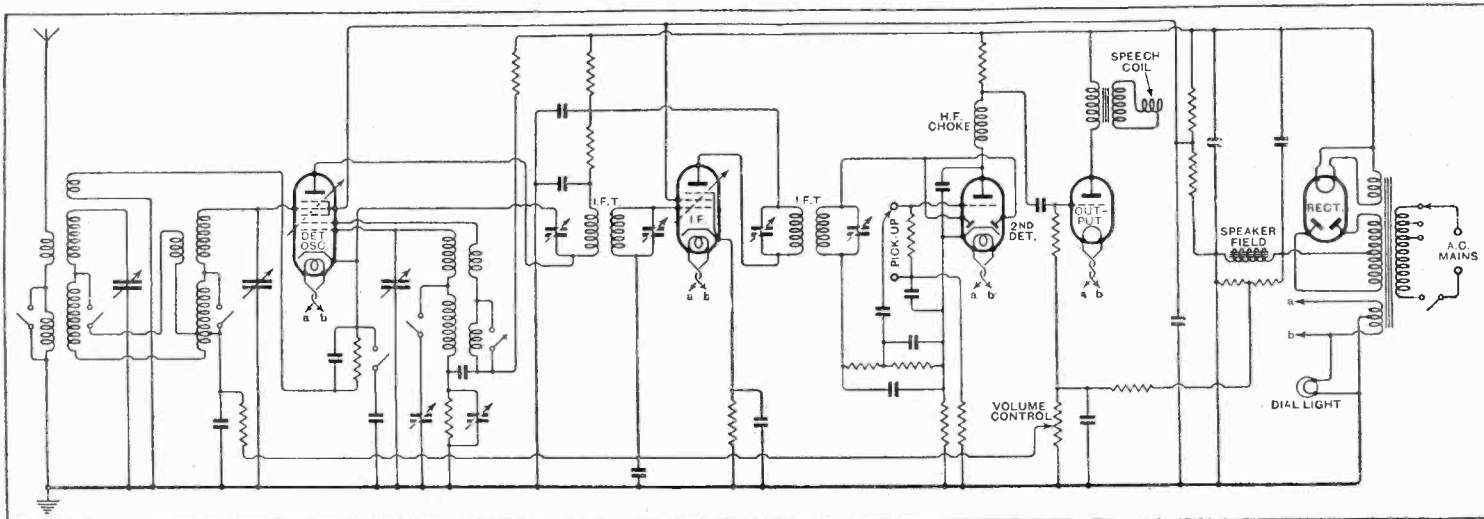

Complete circuit diagram. A heptode valve is used as a frequency changer and a diode triode in the second detector stage.

New Apparatus Reviewed

BRITISH RADIOPHONE I.F. TRANSFORMER

THE superheterodyne I.F. transformer made by British Radiophone, Ltd., Aldwych House, Aldwych, London, W.C.2, is of the fixed band width type, as provision is not made for varying the coupling between the coils. From tests made with some specimen transformers it would seem that optimum coupling is adopted as one peak only appears on its response curve.

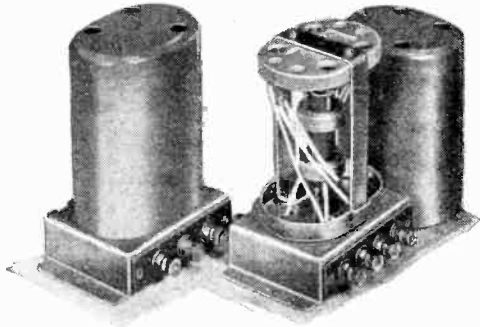

British Radiophone 110 kc/s I.F. transformers: one with cover removed.

High selectivity will, therefore, be a feature of all I.F. amplifiers in which this transformer is included, but a measure of tone correction will be desirable, and this may be obtained either by the use of a pentode output valve or by a tone compensated stage in the L.F. amplifier.

Both primary and secondary windings are tapped, that on the former giving an alternative connection for the anode of the preceding valve, while the secondary tap can be utilised to relieve this circuit of detector damping.

The small trimmer condensers are mounted above the coils, and access to their adjusting screws is given by holes in the aluminium cover. These condensers provide sufficient latitude to tune both circuits accurately to 110 kc/s under all conditions. Three terminals joining to inner, outer and tapping point respectively of each winding are mounted on opposite sides of the base, and the price is 10s.

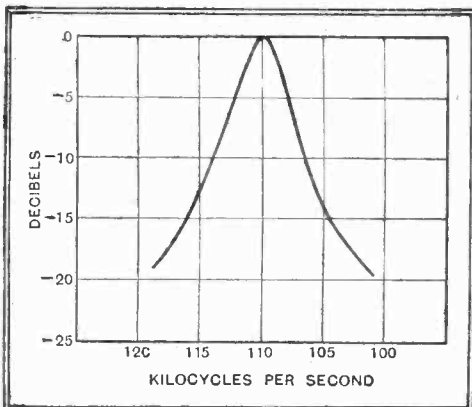

Response curve of British Radiophone I.F. transformer using anode tapping on primary winding.

POLAR STAR MINOR SUPERHET CONDENSER

THE new range of gang condensers recently introduced by Wingrove and Rogers, Ltd., Arundel Chambers, 188-189, Strand, London, W.C.2, and known as the

INTERESTING RADIO PRODUCTS

Star Minor models were developed to provide an efficient and accurately matched condenser unit in compact form. The three-gang model, for example, requires a baseboard space of 6in. x 4½in. including the drive, and the overall height is 4½in.

Rigid steel frames with the rotors carried in bearings of adequate size and entirely free from end-play and trimmers mounted on the top for accessibility constitute a few of the principal features of the new models. In the superheterodyne types the front section is fitted with tracking vanes shaped to maintain a 110 kc/s frequency separation with the pre-selector circuits when employed with coils of 157 m-henrys for medium waves and 1,900 m-henrys for the long waves in signal frequency circuits and 126.5 m-henrys and 925 m-henrys respectively for the oscillator coils. On long waves a series padding condenser of 0.002 mfd. is specified to give correct tracking. This should be semi-variable.

Tests made with a three-gang type show very good matching between the two sections of equal capacity. At one part of the scale only was the makers' tolerance

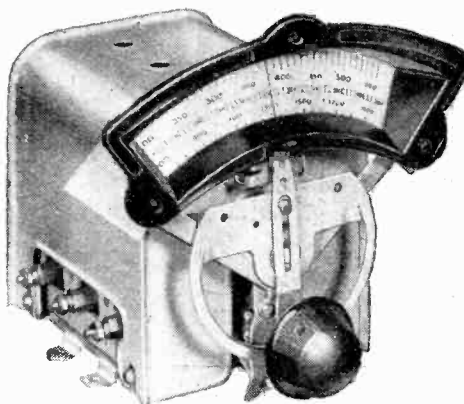

Polar Star Minor Superhet three-gang condenser.

of one half per cent. plus or minus one half micro-mfd. exceeded, but even so the deviation was no greater than one per cent. of the capacity which is a quite tolerable amount.

Tracking is satisfactory when using coils of the stated inductance and with a total minimum capacity of the order of 70 mfd.; incidentally, with this minimum value the wavelength calibration of the Polar dials is then substantially accurate.

The small trimmers allow a variation of 57 m-mfd. each, while the measured minimum capacity of each 0.005 mfd. section is 20 m-mfd. A three-gang model costs 18s. 9d. and a four-section type 25s.

RONNIE SCIENTIFIC EARTH TUBE

THIS earthing device consists of a perforated copper tube 12in. long and 1in. in diameter, fitted at one end with a stout gunmetal ferrule and at the other with a cup-shaped head, also of gunmetal, and to which is attached a terminal for the earth wire. The tube is filled with a special mineral compound, actually a preparation of copper sulphate, which possesses the property of attracting and absorbing moisture.

Ronnie chemical filled earth tube and carton of special mineral compound.

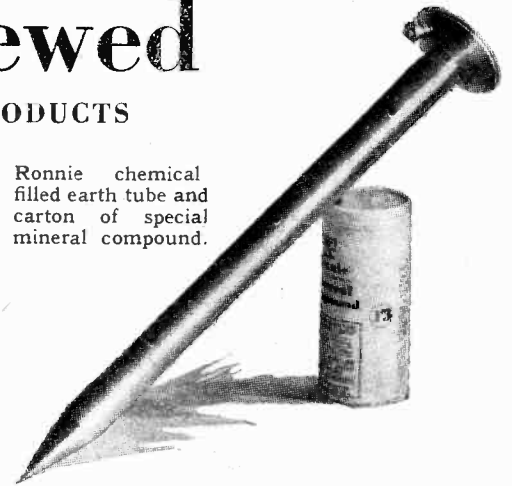

Its particular function is to lower the resistance of the earth connection, thereby improving the aerial system and so enhancing the performance of the receiver. The chemical is not only very hygroscopic, but it is also of a deliquescent nature, for even on the driest of days it absorbs moisture so rapidly that within a few hours it is in a liquid state and remains so indefinitely.

In order to assist the initial percolation of the chemical after the tube has been sunk in the ground a little water should be poured into the cup-shaped head. This will find its way out through the holes carrying with it the chemical into the surrounding soil. If during exceptionally dry weather some water is poured occasionally into the tube, or on to the ground in the immediate vicinity, it will assist in maintaining a good earth connection.

The price is 5s., and the makers are Ronnie Engineering, Crewdson Road, London, S.W.9. The special chemical is available separately in cartons containing sufficient to treat an existing earth at 1s. 3d.

METAL CHASSIS FOR NEW MONODIAL SUPER

PROSPECTIVE constructors of the New Monodial Super receiver may be interested to learn that metal chassis for this set can now be obtained from the London Radio Development Services, 56, Hazel Road, London, N.W.10. They are made of 18 S.W.G. sheet steel, aluminium finished, and with holes drilled according to specification.

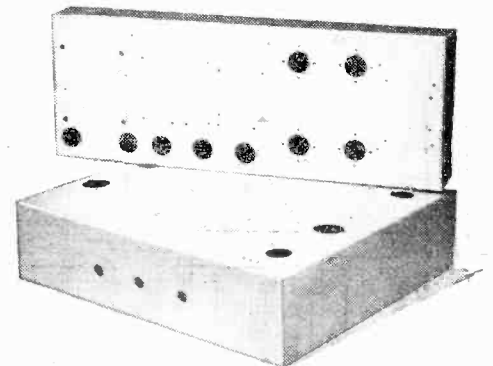

Receiver and power pack metal chassis for new Monodial Super, made by London Radio Development Services.

The receiver chassis is a full 12in. x 14in., and that for the power pack a shade over 18in. long x 6½in. wide. Fixing lugs, tapped to take 2BA screws, are fitted at each corner, and the price is 10s. 6d. for the receiver chassis and 7s. 6d. for the power pack chassis.

The Wireless World

THE PRACTICAL RADIO JOURNAL
23rd Year of Publication

No. 738.

FRIDAY, OCTOBER 20TH, 1933.

VOL. XXXIII. No. 16.

Proprietors: ILIFFE & SONS LTD.

Editor:
HUGH S. POCOCK.

Editorial,
Advertising and Publishing Offices:
DORSET HOUSE, STAMFORD STREET,
LONDON, S.E.1.

Telephone: Hop 3333 (50 lines).
Telegrams: "Ethaworld, Watloo, London."

COVENTRY: Hertford Street.

Telegrams: "Cyclist, Coventry." Telephone: 5210 Coventry.

BIRMINGHAM:

Guildhall Buildings, Navigation Street, 2.

Telegrams: "Autopress, Birmingham." Telephone: 2970 Midland (3 lines).

MANCHESTER: 260, Deansgate, 3.

Telegrams: "Ilife, Manchester." Telephone: Blackfriars 4412 (4 lines).

GLASGOW: 26B, Renfield Street, C.2.

Telegrams: "Iliffe, Glasgow." Telephone: Central 4857.

PUBLISHED WEEKLY. ENTERED AS SECOND CLASS MATTER AT NEW YORK, N.Y.

Subscription Rates:

Home, £1 1s. 8d.; Canada, £1 1s. 8d.; other countries abroad, £1 3s. 10d. per annum.

As many of the circuits and apparatus described in these pages are covered by patents, readers are advised, before making use of them, to satisfy themselves that they would not be infringing patents.

CONTENTS

	Page
Editorial Comment	313
Simplified A.V.C.	314
Why Tune by Wavelength?	316
A.V.C. Three	318
News of the Week	320
America's Latest	321
Unbiased	322
The Crystal Cell	323
FOREIGN PROGRAMME SUPPLEMENT, pp. I—XXIV	
Broadcast Brevities	325
Delayed Speech	326
Car Radio at Olympia	327
Letters to the Editor	328
Practical Hints and Tips	329
Columbia "Radiograph" Model 1003	330
New Apparatus Reviewed	331
Readers' Problems	332

EDITORIAL COMMENT

Codicil to Lucerne

Technicians Hampered by Political Issues

THE Lucerne Broadcasting Conference was called with every apparent desire on the part of the delegates to set to work to produce order out of chaos and arrange the wavelength distribution of Europe on lines which it was hoped might prove to be foundations of permanence.

The Conference achieved a great deal. A plan was evolved which had every appearance of proving successful, and the majority of the broadcasting authorities of Europe subscribed to it. There were, however, certain exceptions, and in the end it was found that eight countries declined to bring their broadcasting stations into line under the new scheme; and so another conference has just been sitting at Amsterdam with the object of trying to bring in these remaining dissentients.

It requires no great imagination to realise that the success of a new wavelength distribution plan in Europe is dependent upon all countries adopting it and agreeing to abide by the allocation of wavelength made to every transmitter in Europe. Even one or two undisciplined stations can easily wreck a scheme of this nature.

The Amsterdam Conference broke up last week and its result is, unfortunately, most disappointing. Agreement has not been reached, and unless there is a subsequent "settlement out of court," it seems doubtful whether the Lucerne Plan will give any special advantages over the present distribution of wavelengths, because the Plan, in its very conception, depended upon unanimity of acceptance.

Before we attempt to consider the reasons for failure we must refresh our minds as to the constitution of the

Union Internationale de Radiodiffusion, under whose auspices these conferences have been held. The Union is exclusively a technical body. It has no authority to dictate to Governments, nor to interfere with the internal organisation of the Broadcasting authorities. Its purpose is to endeavour to establish broadcasting in Europe on the most satisfactory lines to ensure efficient service to the listeners of each country. Technical improvements in stations and systems are dealt with, but, above all, the problem before the Union has been the allocation of wavelengths to each country on a basis of equity and bearing in mind the paramount necessity for avoiding mutual interference between stations on adjacent wavelength channels.

A Political Tool

If these technical matters could be left in the hands of the technical experts to decide we believe that there would soon be found a satisfactory solution. Unfortunately, however, even the Lucerne Plan was subject to the approval of each Government concerned, and here the trouble began. Broadcasting in Europe to-day is no longer guided by the consideration of service to the listener as it once was; it has become a political tool and each Government seems determined that it shall not concede anything to its neighbour. The technical conferences of the Union might carry on for ever unproductively if their work is to become merely subject matter for political disagreement in the end.

The Lucerne Plan, it appears, will still be put into force in January, but it will fall far short of expectations in its scope. Particularly it would seem that on the long-wave band, little or no progress has been made towards a proper solution of the problem of wavelength allocations.

Simplified A.V.C.

A GOOD deal of attention has been given lately to the subject of automatic volume control so that its inclusion might well be added to the list of modifications wherever it has been decided to retain last season's model for this winter's session. In this article the author explains how the new A.V.C. units can be used to the best advantage.

How the New Units Can be Applied to Existing Receivers

IT is not always an easy matter to decide how far modifications to an existing receiver can be carried with advantage, for if the set is of an early vintage, alterations that entail considerable expense may not be justified. Yet if the set is to do duty for another season an overhaul, and possibly a few minor alterations, would be well repaid. When reviewing this matter consideration might well be given to the possibility of incorporating automatic volume control, for with the introduction of some inexpensive units it can now be embodied in practically any type of receiver in a simple and

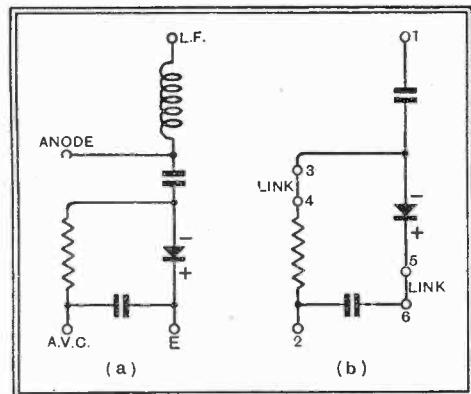

Fig. 1.—Circuit connections of the A.V.C. units showing (a) Varley model, (b) Wearite model.

straightforward manner. Moreover, the alterations required are of a quite minor nature.

These A.V.C. units, as they are termed, are fitted with the Westector, and one is made by Varley and the other by Wearite. Apart from the fact that their operation is similar, and that the same general principles are involved, the two models have very little in common. For, as will be seen from the theoretical arrangement, Fig. 1, the Varley model includes an H.F. choke, whereas the Wearite model does not; furthermore, the latter has a number of terminals shown joined together by links, their purpose being to widen the scope of the unit and enable it to be used in a variety of different ways.

These units operate in conjunction with the detector valve, and if an H.F. choke is already in use it should be removed when the Varley model is fitted but retained for the Wearite version. The H.F. choke deflects the high-frequency component of the anode current to the A.V.C. circuit, where it is rectified by the Westector into a D.C. voltage; this potential is

By
H. B. DENT

then fed back to the H.F. or I.F. valves in the form of a negative grid bias. Since this is provided by the carrier wave of the station received it follows that when a strong signal is tuned in, say, one that normally would overload the detector, a negative bias of considerable value is developed; this is passed back to the H.F. stages, restricts the amplification, thereby doing the same work as a manual control.

Fitting the Unit

In most cases the original detector circuit will include an H.F. by-pass condenser, such as C in Fig. 2, but as this offers an easy path for the H.F. currents, and so virtually short-circuits the unit, it must be removed, as the whole of the hitherto unwanted H.F. in the anode circuit is now required to pass through the A.V.C. unit, where it is utilised to good purpose in providing the control bias. The unit, therefore, detracts nothing from the performance of the set; it is not making use of energy required for other purposes, but only of that which otherwise would be drained carefully to earth.

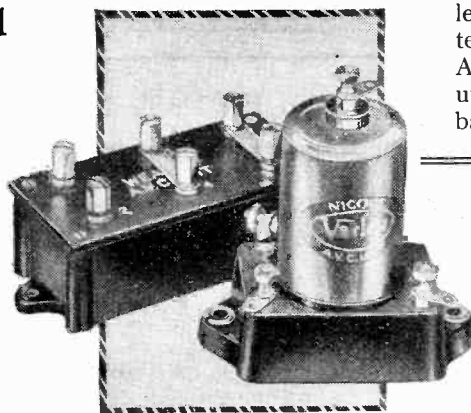

The Wearite and Varley A.V.C. units mentioned in the text.

The other alteration relates to the grid bias circuits of the valves to be controlled. If the set is battery operated the earth end of the grid circuit would be taken to a tapping on the grid battery, or possibly to a separate grid cell. This lead is removed and extended to connect to the A.V.C. terminal on the unit, and the deposed grid battery inserted between

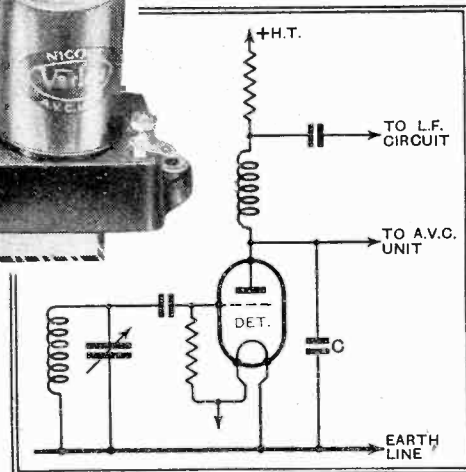

Fig. 2.—When an A.V.C. unit is fitted the by-pass condenser C must be removed.

the unit's earth terminal and the earth line in the set, the change being explained by Fig. 3. Here the grid cell is moved from the old position X to the new position Y.

These circuits show the connections for simple A.V.C. but in the Wearite model the internal connections are so arranged that delayed A.V.C. can be employed if required, the delay voltage being derived from a small grid battery joined to the terminals 5 and 6 after removing the connecting link. There are two other terminals strapped together on this unit, namely, those marked 3 and 4. By removing the link and replacing it by a high-resistance potentiometer the bias voltage fed to the controlled valves can be adjusted to the

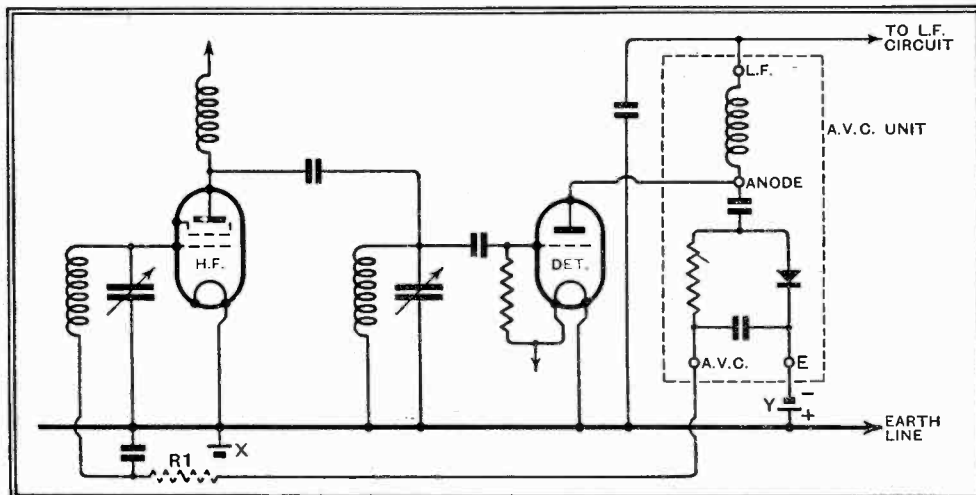

Fig. 3.—Showing the addition of simple A.V.C. to a set; the G.B. battery is changed from X to position Y and if the grid return lead is unduly long a decoupling resistance R1 may be necessary.

Simplified A.V.C.—
most suitable value for the best operating conditions. In its simplest form the circuit would be arranged as shown in Fig. 4.

stant frequency. Superheterodynes are enjoying a well-merited popularity in view of their inherent selectivity, so that the units might well be embodied in the de-

catered for. Adding one of these units entails very little alteration, even assuming that an elaboration like delayed and controlled A.V.C. be attempted.

The skeleton circuit, Fig. 6, shows the essential changes necessary. First, one of the H.F. filter condensers in the anode circuit of the second detector is removed, a lead joined from terminal 1 on the unit to the valve's anode and the grid return leads, hitherto joined to the slider of R10, disconnected and attached to terminal 2 on the unit. A potentiometer of 250,000 ohms is then fitted, and its ends taken to terminals 3 and 6 (after removing the link joining 3 and 4), the sliding member of this is then joined to terminal 4. Terminal 6 is now returned to the slider of R10 and a 1.5-volt grid cell connected in place of the link joining terminals 5 and 6. The grid cell gives the delay voltage and R11 an adjustment for the control bias fed back to the earlier stages.

From the foregoing it will be seen that these small units have a wide field of usefulness, and although only a brief résumé of their application and possibilities has

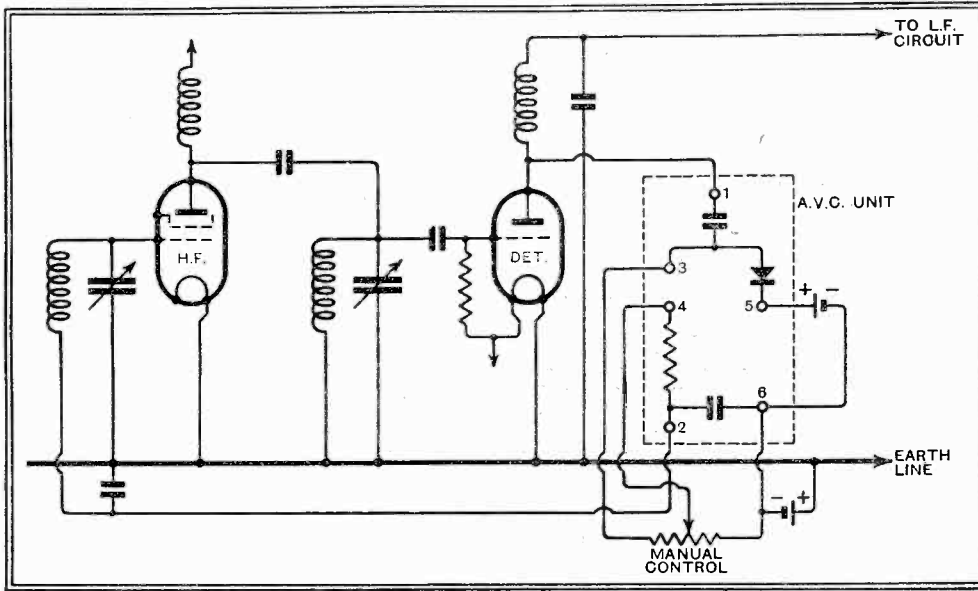

Fig. 4.—Circuit arrangement for delayed and controlled A.V.C.; the manual control is a high resistance potentiometer of 250,000 ohms.

If the manual control is not fitted a fixed resistance of 250,000 ohms should be joined between terminals 3 and 6, but leaving 3 and 4 strapped together.

So far we have limited the discussion to the general application and operation of the units, and straight sets of the more simpler type have served to illustrate these principles. While a fair measure of control is afforded in such cases the particular characteristics of these rectifiers tend to favour frequencies lower than those of the medium broadcast band so that control will be far more marked on the long waves. The curves in Fig. 5 well illustrate this point, and it would seem that the units serve their purpose best in superheterodyne circuits and working in conjunction with the second detector valve where the H.F. potentials are maintained at a con-

sign, or added to existing sets if not so equipped.

They will find, also, a very useful application in the short-wave field where the need for an anti-fading device is so often felt. Consequently, where short-wave converters of the superheterodyne variety are operated in conjunction with a broadcast set, the addition of an A.V.C. unit will prove very beneficial and well justify the small expenses involved. The same would apply to sets in which provision is made for short-wave reception in addition to the normal wavelengths.

Of the more recent *Wireless World* receivers the All Wave Monodial Super could be taken as a very good example of the type of receiver in which A.V.C. is likely to prove most useful, for in this case short-, medium- and long-wave reception is

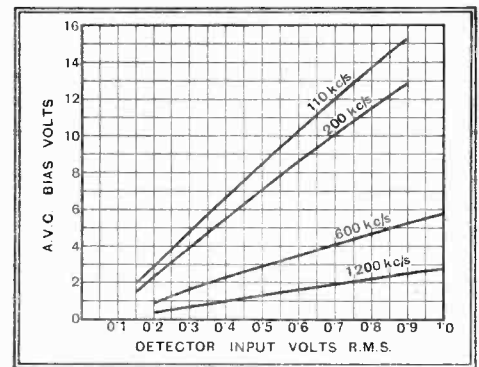

Fig. 5.—Curves showing D.C. output from A.V.C. unit at various frequencies using a leaky grid detector.

been attempted here, it serves to show how one of the latest developments can be most usefully employed in conjunction with existing receivers.

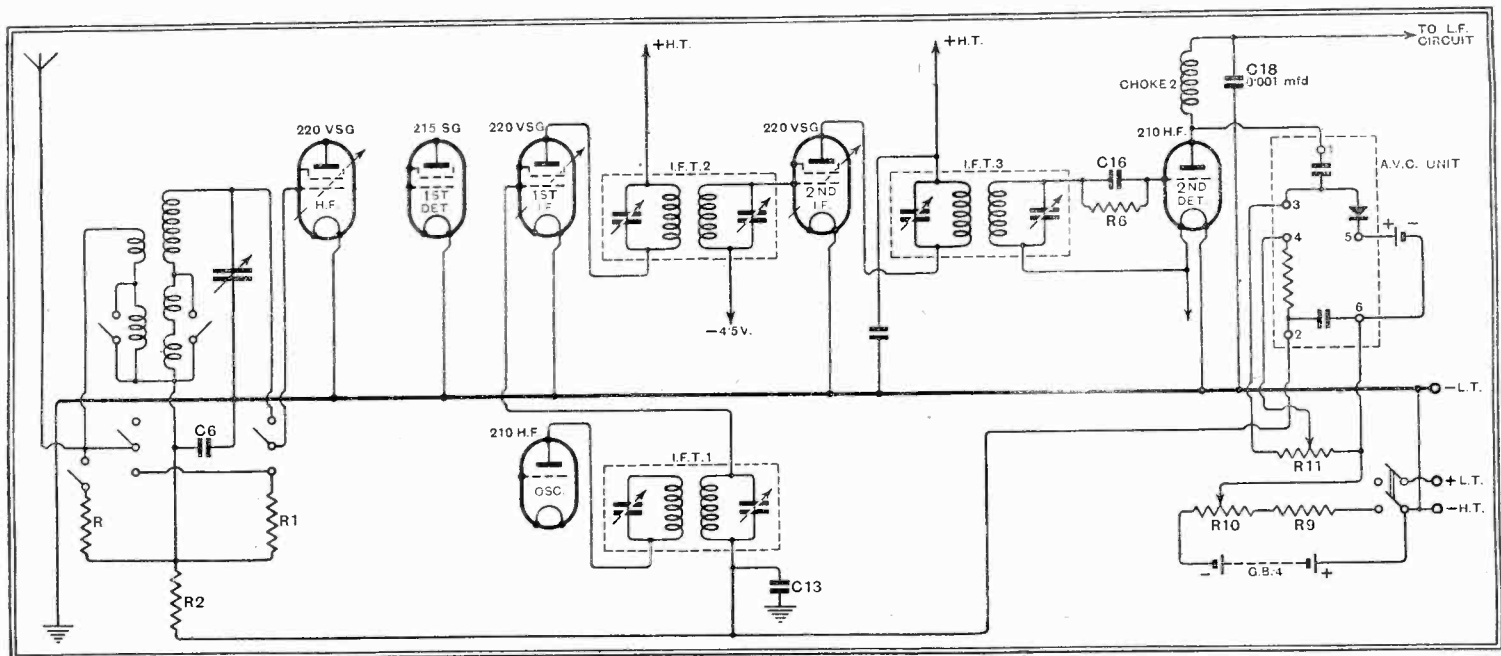
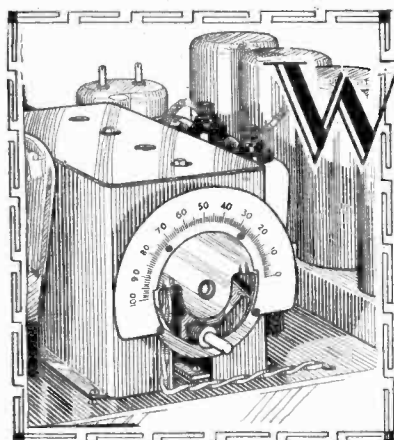
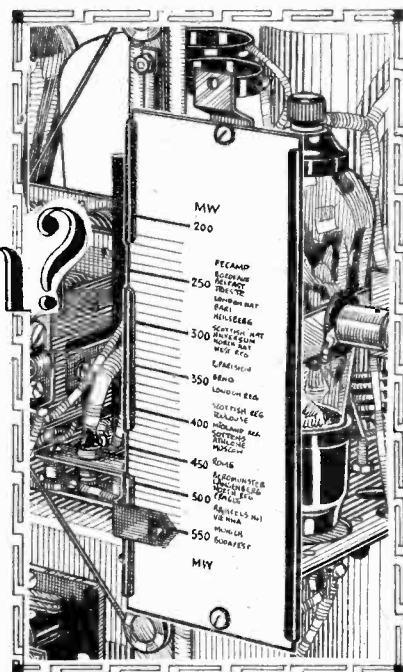

Fig. 6.—Modifications in the circuit of the All Wave Monodial to include delayed and controlled A.V.C., using one of the new units.



Why Tune by Wavelength?

By R. W. HALLOWS, M.A.



Numbered Channels : A New Scheme

SO long as stations remain closely identified with their wavelengths or frequencies, confusion is bound to arise when wavelength changes occur, even of a minor nature. The author puts forward an interesting scheme for the abolition of the familiar scale in favour of numbered channels.

GOOD as it is in most ways, the Lucerne Plan, which is due to come into operation on January 15, raises some rather pretty problems for both set makers and set users. So much use has been made of the station-name tuning dial this season that comparatively few of the bigger sets, of what may be called the domestic type, have anything else. Personally, I doubt whether this kind of dial is really so popular as many manufacturers and designers believe, but that is by the way.

How Confusion Arises

The really important fact is that any station-name dial which is correctly marked off for present conditions will be utterly incorrect as soon as the Lucerne Plan is in being. Most makers have designed their dials this season so that a new scale showing the "Lucerne" tunings can be substituted at small cost. But this by no means solves the problem. Within a few weeks, for instance, it is probable that Berlin Witzleben will take over Stuttgart's wavelength, whilst Stuttgart will exchange with Munich, and Munich will use the 419.5 wavemetre left vacant by Berlin's move. And it is quite possible that there will be similar wavelength changes or exchanges between stations in other countries between now and the end of the year.

Again, it may be regarded as a certainty that considerable adjustments will be found necessary if and when the Lucerne Plan is put into operation. No one can tell until actual tests have been made whether partners such as Bolzano and Wilno can work harmoniously together on a shared wavelength. Wilno might have to change channels with Tunis or Morocco, whilst the Italian authorities might find it better to make use of the channel for Bari or the second Milan station instead of Bolzano. Any country to which a certain number of channels has

been allotted may find it desirable to alter to some extent the original disposition of its stations. The B.B.C., for example, may possibly discover that better working is obtained if the Scottish Regional exchanges with the Midland, or the North National with the London. Nor is there any reason why (with the consent of the U.I.R., of course) a country should not "swap" one or more of its channels with another.

Though it may be sound enough to arrange for the engraving of one lot of scales now and another for the opening of the Lucerne Plan, it would clearly be uneconomical, even if it were possible, to provide for an indefinite number of replacements. Hence, as time goes on, the existing station-name scales must become less and less correct.

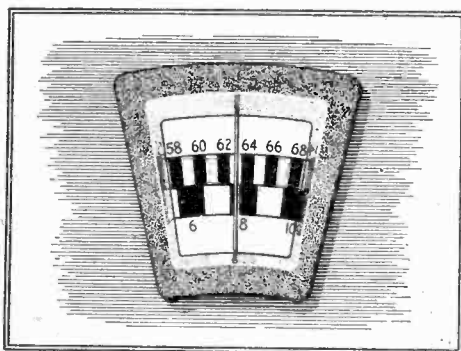

The suggested new tuning dial. The medium- and long-wave divisions each cover a width approximating to that of a frequency channel.

Can some means be devised for retaining the simplicity of station-finding furnished by the "name" dial, and at the same time avoiding the necessity for constant replacements—or the alternative of increasing inaccuracy as month follows month? I believe that it can, and the purpose of the present article is to suggest a method which appears to have many important advantages.

A wavelength marking off for the tuning dial is unsatisfactory, since with the logarithmic variable condenser now used in almost all sets it leads to uncomfortable crowding in some portions of the scale; and, after all, the Lucerne Plan, like its immediate predecessors, has a frequency basis. Then why not kilocycles? The man in the street has demonstrated in the most emphatic manner in the world that, despite the several campaigns that have been made in their favour, he declines utterly and absolutely to think in kilocycles. He has an instinctive distrust of anything that works "widdershins," and to him it is absurd to demonstrate that Fécamp should be higher in the scale than the London National, when he knows that it is lower!

Why not abandon metres and kilocycles alike both for the marking off of tuning dials and for the "ranking" of stations in the printed lists? If the Lucerne Plan is founded upon the kilocycle it has also another even more important basis, the channel. I suggest that if we adopted channel numbers both for tuning dial calibration and for the order of stations in the lists, a great simplification would occur, and the dial problem that now faces designers would cease to exist.

Numbering the Channels

In the United States of America, where a 10-kilocycle separation between stations prevails, something of the kind already exists, and it is found to work most satisfactorily. There 840 kc/s is known as Channel No. 84, 850 kc/s as Channel No. 85, and so on. With our nominal 9-kilocycle basis we cannot assign channel numbers by the very convenient process of knocking off the final nought from the kilocycle figure. But there seems to be no good reason why the European channels should not be numbered.

Under the Lucerne Plan there are 130

Why Tune by Wavelength?—

channels, occupied by 232 stations, existing or projected. Fifteen of these channels are on the long waves, between 1,100 and 1,875 metres; six on the intermediate waves between 696 and 845 metres; and 109 on the medium waves between 200 and 578 metres. My proposal is that these channels should be numbered straight down from No. 1 on 1,875 metres to No. 130 on 200 metres.

The Lucerne list for the long-wave stations would thus read as follows:—

Channel No.	Station.
1	Brasov.
2	Radio-Paris, Syria.
3	Moscow I.
4	Angora, Kaunas, Madrid I, Reykjavik.
5	Königswusterhausen.
6	Daventry.
7	Minsk.
8	Motala.
9	Huizen, Kharkov.
10	Warsaw.
11	Kalundborg, Portugal.
12	Leningrad.
13	Oslo.
14	Lahti.
15	Moscow II.

Channels Nos. 16 to 21 would be for the intermediate stations; the top of the medium-wave list would begin:—

Channel No.	Station.
22	Hamar, Innsbruck.
23	Ljubljana, Tampare, Finnish C.W.
24	Bolzano, Wilno.
25	Budapest.
26	Beromunster.
27	Aihlone, Palermo, Italian C.W.
28	Muhlacker.
29	Madona, Tunis.
30	Vienna.

The Midland Regional would be shown as occupying Channel No. 49, Berlin No. 57, the London Regional No. 61, Hilversum No. 74, and so on down to the 200-metre International Common-wave on Channel No. 130.

It is unlikely that any commercial sets will be made to take in the intermediate channels (Nos. 16 to 21) on wavelengths between 696 and 845 metres, since most of these are assigned to stations comparatively unimportant from the point of view of the British listener. If, therefore, the suggested scheme is adopted his tuning dials will contain two scales, one from Channel No. 1 to Channel No. 15, and the other from Channel No. 22 to Channel No. 130, or as far "down" as the circuits of the set will tune.

At this point it may be well to consider several objections that may have been brewing in the reader's mind. He will already have thought that the long-wave channels are not assigned on a 9-kilocycle basis; and again that, whereas the separation is 8 kc/s in the majority of cases, it is 7 kc/s in some and 9 kc/s in others.

It is not suggested that the dial should be marked off into precise *points*

at which any station will be found. The channel covers a certain frequency-width, and my idea is that the markings should be, as shown in the accompanying drawing, alternate black and white areas of a width corresponding approximately to that of the channels. That is, Daventry will be found within the limits of the light space numbered 6, Huizen within those of the shaded space numbered 9, and so on.

Ease in Tuning

If for the long-wave stations the dial spacing is laid out on an 8-kilocycle basis throughout, there will be very little error, as is shown by the following table.

Channel No.	Actual Frequency (K.C.)	Frequency at 8 K.C. Separation.
1	160	160
2	167	168
3	175	176
4	183	184
5	191	192
6	200	200
7	208	208
8	216	216
9	223	224
10	230	232
11	238	240
12	245	248
13	253	256
14	262	264
15	271	272

Since the whole channel would occupy a fairly large space on the tuning dial, and the mid-point of this space would correspond to the calculated frequency, there would be no difficulty in tuning in a desired station or in identifying one that had been tuned in, provided, of course, that the makers' calibration was reasonably accurate.

On the medium waveband the basic channel separation is 9 kilocycles, though in about a dozen instances this is increased

to 10 kilocycles. All of the 10-kilocycle separations, however, occur between 251 and 559.7 metres (Channels Nos. 96 and 24); a satisfactory degree of accuracy in tuning would therefore be obtained if the designer made the mid-points of the channel spaces on his dial correspond to a frequency separation of about 9.2 kilocycles between these limits.

The beauty of the numbered channel system is that the correctness of the tuning dial is utterly unaffected by internal channel exchanges made by any country, or by "swaps" between country and country. Nor is the listener troubled by small adjustments of the frequency of any channels. He is never called upon to memorise anything greater than a three-figure number for any station, and the non-technical man can forget as soon as he likes all about metres and kilocycles, which are in any event meaningless terms to him.

Do you Agree ?

The expert does not suffer, for he can readily calibrate his set by means of the division or degree scale for accurate work, making use of the channel markings only as a rough guide.

If manufacturers and the broadcasting authorities will co-operate, there is no reason why the suggested scheme should not be adopted without delay. There is no question that its adoption would simplify matters for the set maker and the set user alike. The scheme has been maturing in my mind for some months now, and I can see no valid objection to it. One is always apt, though, to turn one's own geese into swans. Readers may see some flaw that has not occurred to me, and their opinions on the subject will be most valuable.

Much of the value of the scheme would be lost if it were not widely adopted; all programmes and station lists should refer to "channel numbers."

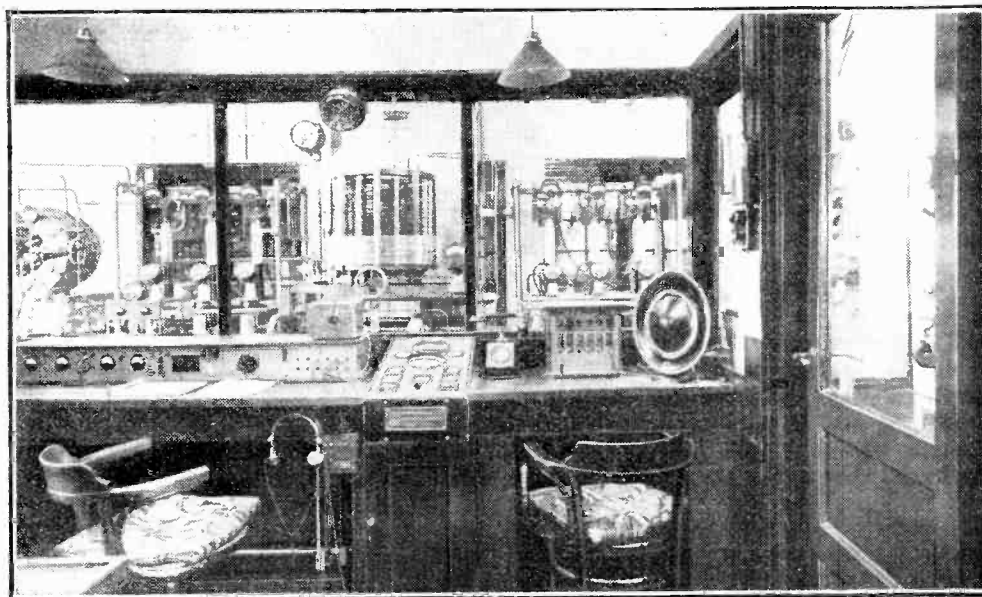

OCCUPYING "CHANNEL No. 9." The control desk at the Huizen medium-wave station, one of the most popular continental transmitters among listeners in this country.

"The Wireless World"

A.V.C. Three

An A.C. Mains Set with the Latest Automatic Volume Control

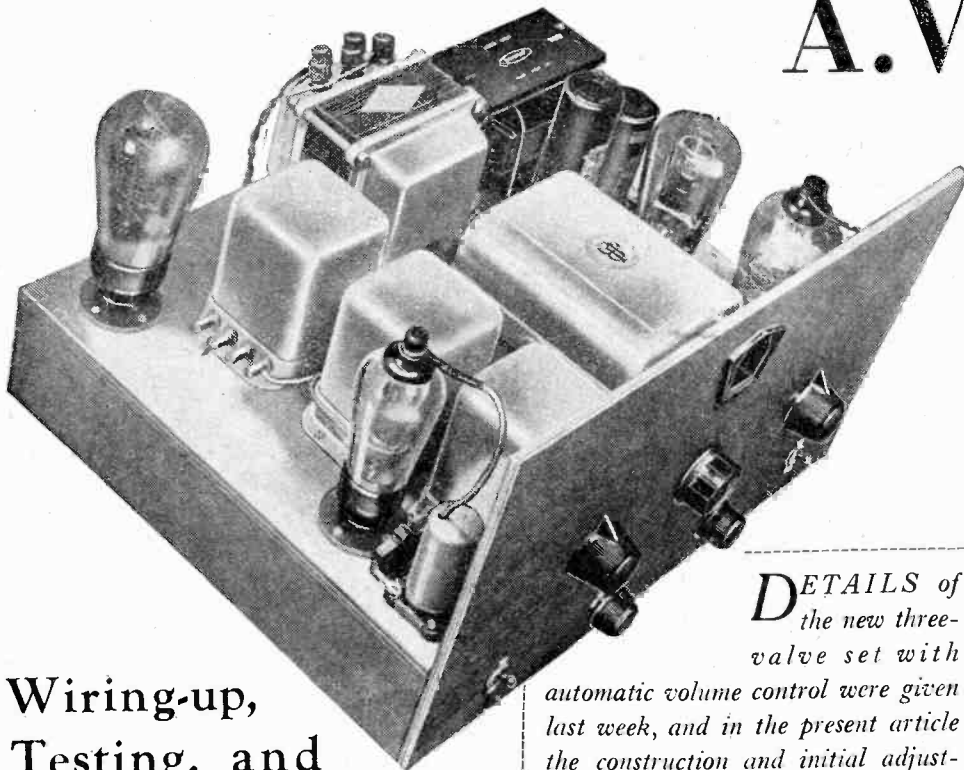

Wiring-up, Testing, and Operating Notes

CONSTRUCTIONALLY, there is little to cause difficulty in assembling the receiver. It will be found that many of the terminals on the coils cannot be reached with the gang condenser in position, and it is recommended, therefore, that the mounting of this component be left to the last. The leads to its terminals should be attached before mounting, and it may then be easily dropped into place and connected up. It should be noted that the electrolytic condensers C17 and C18 must be insulated from the metal chassis, since there is some 50 volts difference of potential between the condenser cases and the chassis. The insulation is most easily achieved by mounting the condensers on a small strip of insulating material with a strip of copper foil beneath the condensers themselves for the negative H.T. connections. Large clearance holes can then be drilled in the chassis and the condenser assembly mounted in place.

The Filter Coupling

The condenser C1 remains to be dealt with. No component with a sufficiently small capacity is available, and it is necessary for it to be home-made. A minute capacity will suffice, and two $1\frac{1}{16}$ in. lengths of No. 16 gauge wire form the plates. One end of each wire is soldered to the terminal tags of the fixed plates of the gang condenser sections, tuning the filter, in such a way that the wires overlap by about $\frac{7}{8}$ in. A piece of thin sleeving is then slipped over each wire to insulate them from one another,

DETAILS of the new three-valve set with automatic volume control were given last week, and in the present article the construction and initial adjustments are dealt with, while attention is also paid to the operation of the receiver. Although several controls are included, only two are strictly used for tuning, the rest requiring but occasional adjustment.

and the two tied together to keep them in place. Should it be found on test that the sensitivity of the set falls off excessively on wavelengths above 500 metres, the overlap of the wires should be increased slightly. Conversely, if the selectivity falls off at one end of the scale to any great extent, the overlap should be reduced. It should be pointed out that if care be not exercised in the wiring of the filter circuits, the stray capacities

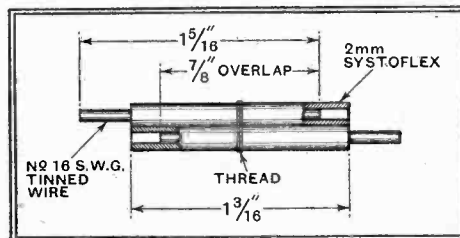

The filter coupling condenser C1 is constructed from two overlapping lengths of No. 16 gauge wire, and is supported by soldering it to the connecting tags of the gang condenser.

existing here may themselves be too high for correct coupling, and without C1. With the normal arrangement of the wiring, it should be possible without any condenser C1 to receive stations over the whole waveband, but the general sensitivity will be low and the selectivity high.

The initial adjustments are confined to the ganging, and this can readily be

carried out by operating the star-wheels on the gang condenser. The local-distance switch S1 should be closed to give maximum sensitivity, and a station on a very low wavelength tuned in, using as much reaction as possible without the set actually oscillating. If the station be strong enough to bring A.V.C. into action, a meter connected at the point "X" on the circuit diagram must be used as an indicator of signal strength. A meter with a full-scale reading of about 10 mA. is suitable, and the lower the current registered when the set is tuned to a signal the stronger is that signal.

If no meter be available, then a very weak station must be chosen for carrying out the adjustments, so that A.V.C. is inoperative. Each trimmer must be adjusted for optimum signal strength, using as little capacity as possible in any trimmer. If too much trimmer capacity be used the wavelength range will be restricted, and it will be impossible to tune down to 200 metres. If it be found, therefore, that all trimmers are some distance from minimum, they should all be unscrewed slightly, the station retuned at a slightly higher dial setting, and the set re-ganged. The final result should be the trimmer on the intervalve circuit nearly fully unscrewed.

The Action of A.V.C.

In general reception the receiver will be found to behave normally on weak signals. for A.V.C. is then inoperative owing to the delay action. When a signal is fairly strong, however, it will be found that reaction makes no appreciable difference to the volume, for the increase of signal strength brought about by the application of reaction is offset by the increased grid bias on the H.F. valve, which results through the employment of A.V.C. On a moderately strong signal the only result of applying reaction is to increase the selectivity and sideband cutting. If interference be experienced, therefore, it may often be avoided simply by increasing reaction without the necessity for simultaneously reducing the volume control setting as in older receivers. The tone will become deeper on applying reaction, and a variation in the setting of the tone control may be needed to offset this.

How to Wire Up the Receiver

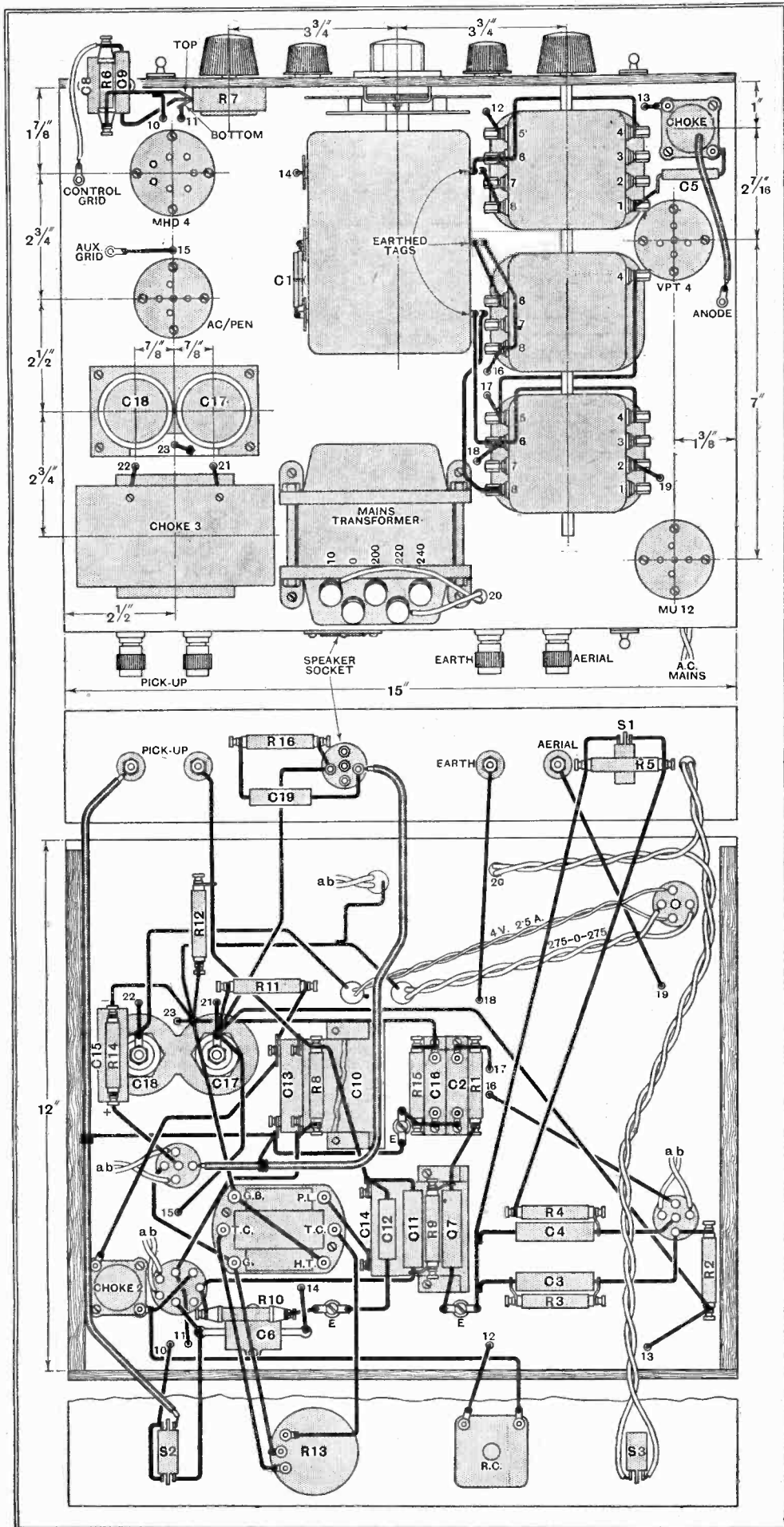

The layout of components and the method of wiring *The Wireless World* A.V.C. Thre. can readily be seen from these drawings.

Owing to the wide range of control afforded by the tone control transformer and its resistance R13, only slight pentode compensation is necessary; as a result, full compensation for critical reaction becomes possible and good quality is obtainable even on weak stations. On gramophone, of course, where there is no sideband cutting, the tone control will normally be used at the other end of its range to reduce the upper frequencies rather than to accentuate them. Incidentally, the manual volume control is operative on both radio and gramophone.

Owing to the necessity for applying H.F. potentials to the grid of the duo-diode-triode in order to obtain reaction, the input handling capacity of this valve is reduced to about one-half of its normal figure. There is thus a danger of overloading occurring on a strong local station, and to avoid this the local-distance switch S1, which permits an additional 2,000 ohms bias resistance to be thrown in the cathode circuit of the H.F. valve, is fitted. In operation it will be found that the setting of the manual volume control has a slight effect upon the quality of reproduction, and this is unavoidable on account of the necessity for applying H.F. potentials to the control grid, for the presence of C8 means that low and medium frequencies are attenuated by the control more rapidly than high. Owing to the inclusion of tone control, however, this is considered unimportant, for if the tone becomes too high-pitched on reducing volume it is the work of a moment to restore the normal balance with the tone control.

The Performance

It will be found that the set at first appears less sensitive than the usual three-valve receiver due to the effect of A.V.C. in reducing the amplification on strong signals. A little testing, however, will soon show that the station-getting properties are normal, and that full volume can be obtained from the more powerful Continental stations. On test the receiver proved fully up to standard, and many distant stations were obtainable at a strength and with a degree of quality sufficient for their programmes to be of entertainment value.

The quality of reproduction obtainable, of course, depends to some extent upon the speaker employed, but, owing to the inclusion of tone control, considerable latitude is permissible. No provision is made in the design for the energisation of a moving-coil speaker field, since this would necessitate a rectified output of over 400 volts, and would greatly increase the cost of the mains equipment. The speaker should be fitted with pentode-type output transformer of such ratio that the average primary impedance is about 8,000 ohms.

If the best results are to be obtained a

Full-size blue print of this receiver is available from the Publishers at 1s. 6d. each, post free.

"The Wireless World" A.V.C. Three—

good aerial is recommended, and on the reception of a fading station it will be necessary to make full use of reaction if the A.V.C. system is to counteract fading to any great degree. A.V.C. can only maintain a constant output on a fading station if the initial sensitivity of the set is sufficient to maintain the output when the signal is at its weakest. The more sensitive the set, therefore, the better the A.V.C. action, and in the case of a simple three-valve arrangement it is necessary to make full use of reaction. Owing to the presence of the tone control transformer this need not affect the quality of reproduction.

A specimen receiver will be available for inspection by readers at 116 Fleet Street, E.C.4.

TABLE OF VOLTAGES AND CURRENTS

Valve.	Measured Volts.			Measured Current mA.	
	Anode.	Screen.	Grid.	Anode.	Screen.
H.F. V.P.T.4	170	75	1.5	5.7	2.4
Det. MHD.4	200*	—	—	4.28	—
Output Pen.4.VA.. .. .	242*	256*	20	35	3.9

* Measured from — H.T.
 Volts across C18 = 280 volts. Total current through Ch3 = 54.5 mA.
 Volts across C17 = 256 volts.
 Heater volts = 4 volts R.M.S.
 Mains voltage = 235 volts R.M.S. (connected to 230 volts tapping).

All readings taken with Avometer and with the set tuned to no signal.

News of the Week

Current Events in Brief Review

Business or Pleasure

THE most striking piece of electrical apparatus at the Concours Lépine, or Small Inventors' Exhibition, in Paris, was a sewing machine convertible into a wireless set.

Short Waves for the R.A.F.

THE R.A.F. appears to be deserting the long wave band in favour of the higher frequencies. We learn that, for long-distance communication in the East, the 20-100 metre band is coming into use. A special three-valve receiver has been designed with an amplifier employing two stages of screen grids in push-pull.



"TO GUGLIELMO MARCONI."—This bronze statuette—28in. high—has been presented to Marchese Marconi by the American Radio Industry in recognition of his "contribution to the enrichment of human life."

"Empire Broadcasting" from Denmark

DENMARK is shortly to have an "Empire" broadcasting system similar to the B.B.C. model. Special programmes will be broadcast on short waves from Skamlevaek.

Arctic Broadcasting

THE world's most northerly broadcasting station is now being built at Vardo, in Norway. This transmitter in the Arctic will be connected to the Oslo station by combined line and radio link.

Simple but Good

CHILE has evolved a new call sign scheme. After the letters "CE" a station call number is allotted, based on the frequency. Thus, CE58, Santiago, operates on 585 kilocycles, CE88, Valparaiso, on 885 kilocycles, CE92, Temuco, on 925 kilocycles.

South Pole Calling

REGULAR broadcasts from the forthcoming expedition of Admiral Byrd to the Antarctic are to be relayed by the Columbia network in America, but without doubt many amateurs will tune in direct to the Expedition's three transmitters. These have been allotted the frequencies of 6,650, 6,660, 6,670, 8,820, 8,840, 13,185, 13,200, 13,230, 13,245, 13,260, 17,500, 17,620, 21,515, 21,600 and 21,625 kilocycles.

Daily Television

TESTS with 30-line television are now being carried out daily from the Crystal Palace on 6.25 metres, but no set schedule has been arranged. The transmissions are being picked up at good strength up to a radius of 30 miles, and it is interesting to note that better results have been achieved farther afield with single-valve receivers than with multi-valve receivers in the near neighbourhood. Not all observers use television receivers, as, of course, it is quite possible to recognise the transmissions on ordinary sets. We shall be glad to receive reports from our readers who have picked up the tests.

More Power from U.S.

THREE leading American broadcasting stations are already claiming a power of 50 kW as permitted under the new Federal Radio Commission regulations. They are WBZ, Boston-Springfield, WHAM, Rochester, N.Y., and WGN, Chicago.

Moonbeam Wireless

MOONLIGHT in Italy operated relays which illuminated the Chicago Exhibition on "Marconi Day," October 3rd, when the famous inventor attended the Show and received messages of congratulation from all over America. The selected moonbeam was picked up at the Observatory Arcetri, in Tuscany—the last residence of Galileo—and made to operate a photo-electric cell.

The Unfinished

WHETHER the Dutch Government censor has the right to "cut" a broadcast speech when once started has been the subject of a legal action which has lasted three years and is expected to be settled this week. On October 8th, 1930, Mr. Zwert Brock, Secretary of the Dutch Radio Association V.A.R.A., had his speech terminated after he had uttered a few words because it had not been submitted to the Wireless Censorship Commission.

High Hams

OUR congratulations to our contributor, Mr. H. L. O'Heffernan, on securing first place among British competitors in the Fifth International Relay Competition results.

The world's highest score for participants outside the U.S. and Canada was that of the Spanish EAR185, who secured 18,382 points in establishing world contacts. Mr. O'Heffernan, who topped the British list for the fifth year in succession, gained 10,860 points.

Says "Q.S.T.": "It was the biggest, grandest and the hardest-fought battle ever staged by the A.R.R.L."

Radio Newspaper

A "COMPLETE" radio newspaper" is to be broadcast every evening in Oporto. The journal, which will be broadcast by a leading Lisbon newspaper, will include a leading article, feature stories, a serial, magazine section and advertisements.

Paradox

FRENCH listeners are up in arms against a decision of the Post Office in the Gironde Department that war pensioners with defective hearing are not eligible for free licences. According to the French licence regulations, exemption can be claimed by those who have been maimed and mutilated in the war, but, strangely enough, deafness is not considered to come under this category, even in the case of a wireless listener!

Valve Technique

A FILM of the key processes in the manufacture of radio receiving valves will be shown at this evening's meeting of the Radio Society of Great Britain, to be held at 6.15 p.m. at the Institution of Electrical Engineers. The lecturer, Mr. Stephen de Laszlo, B.A. (Director of the High Vacuum Valve Co. Ltd.), will deal with "Technique in Valve Manufacture," and discuss the principles underlying thermionic emission and the principle and problems of high vacuum technique in regard to radio receiving valves.

St. Dunstan's and Wireless

THE war against war blindness goes on at St. Dunstan's, and the Eighteenth Annual Report tells how victory is being achieved. The famous establishment in Regents Park contains many departments, including that of the Electrical Engineer, which gives advice to St. Dunstaners now making their living as wireless set constructors or general electricians. It is interesting to note that the broadcast programmes come to thousands of homes of blind people on apparatus provided by St. Dunstan's.

America's Latest

The Broadcasting Palace in Radio City

By A. DINSDALE

IN the midst of the gigantic enterprise known as Radio City, New York, the National Broadcasting Company will open its new studios on November 15th next, its seventh anniversary.

The writer has just been privileged to make a tour of the new premises under the guidance of O. B. Hanson, Chief of N.B.C.'s Operations Division, who designed the new studios. While the studios were in most cases structurally complete, they were unfinished, much scaffolding was in evidence, and many men were at work.

The central tower, at the base of which the studios are situated, is seventy storeys or 836ft., in height. Because of the large unsupported spans necessary in the construction of large, unobstructed studios, it was obviously impossible to build the studios within the tower itself, which requires a large number of closely spaced, heavy steel columns to support it. Hence, only the N.B.C. offices are within the tower structure proper; the studios are built within a twelve-storey extension.

In all, there are thirty-five studios in Radio City, covering some 400,000 square feet of space. Sixteen of these studios will be completely equipped and in operation on the formal opening night. Eleven more, including five audition studios, will be complete except for technical equipment. The remaining eight, occupying the sixth and seventh floors, will be left

hear the programme through loud speakers. Private observation booths are provided on these floors for the use of programme sponsors and their guests.

On the ninth floor is the largest studio of all. In fact, it is claimed to be the largest broadcasting studio in the world. It measures 78ft. by 132ft., and is three storeys (35ft.) high.

On the tenth floor are four studios arranged clover-leaf fashion around a single central control room. The floor of this control room is a large turntable, upon which the television camera of the future will be mounted, so that it can be focused into only one of the four studios through the sound-proof glass windows. In the meantime this group can also be utilised for the production of dramatic sketches without television, where it is desirable to place an orchestra in one studio, principal actors in a second, crowd noises in a third, and sound effects in a fourth. Up to the present, only one studio has been used for dramatic productions in America, everything being crowded into one room.

All studios have been constructed with an eye to the future possibilities of television. There are no lighting fixtures; all lights are sunk flush with the ceiling,

the covering lenses being so arranged that every part of the studio is evenly lighted. There are no shadows anywhere. The possibility of having to use scenery has also been taken into consideration, and in the case of the largest studio two duplicate control rooms are provided, one on the studio floor level and another on the level of the floor above, so that the control-room staff may have a clear view of every part of the studio, even if scenery is being employed.

One of the most important considerations in the design of modern broadcasting studios is that of sound-proofing. European studio designers have largely eschewed steel framework in the construc-

tion of studio buildings, because steel frames have a tendency to conduct sound and mechanical vibration from one studio to another. In America, prevailing architectural practice and other considerations force steel construction on studio designers. In these circumstances, it is necessary to "float" each studio free of the main frame of the building. This is accomplished by building each studio like a box and insulating the box from the building at all contact points. For this purpose 250 tons of rock wool were used in the Radio City studios.

The studio walls consist of a layer of four inches of rock wool

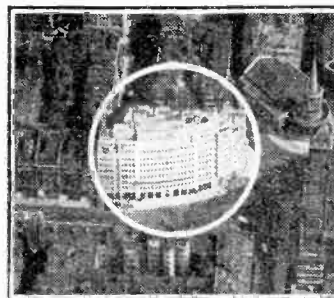

RADIO CITY, with the new broadcasting studios in the circle. Administration and other sections of this great entertainment centre occupy the remainder of the building. (Inset) Broadcasting House, London, on approximately the same scale.



THE WORLD'S LARGEST STUDIO? Here is a portion of the huge "Auditorium Studio" in Radio City nearing completion. It measures 132 x 78ft. and is three storeys in height. The studio can accommodate 1,000 visitors and a 100-piece orchestra.

entirely unfinished for the time being, but will be available for future development.

The fourth, seventh, and ninth floors are studio floors, while the fifth, eighth, and tenth floors are observation floors for visitors, who can see down into the studios through large sound-proof windows and

of the studio, even if scenery is being employed. One of the most important considerations in the design of modern broadcasting studios is that of sound-proofing. European studio designers have largely eschewed steel framework in the construc-

tion of studio buildings, because steel frames have a tendency to conduct sound and mechanical vibration from one studio to another. In America, prevailing architectural practice and other considerations force steel construction on studio designers. In these circumstances, it is necessary to "float" each studio free of the main frame of the building. This is accomplished by building each studio like a box and insulating the box from the building at all contact points. For this purpose 250 tons of rock wool were used in the Radio City studios.

The studio walls consist of a layer of four inches of rock wool

face with "transite," a compressed asbestos material perforated all over with small holes. This is not a very practical wall surface, for it cannot be left bare, it cannot very well be painted, nor can it be covered with wall-paper, which would cover up the perforations and present a rather hard, reflecting surface. The problem is being solved by gluing a specially woven fabric over all studio walls and ceilings. The fabric does not interfere with the acoustical treatment, and permits "breathing" through the fabric and transite. Different coloured fabrics are used in different studios.

America's Latest—

In some of the studios heavy drapes, suspended on rails, are provided to vary the acoustics to suit different circumstances. In others, great panels can be slid back in the walls to reveal hard reflecting surfaces. These panels are motor-driven, and controlled by switches in the studio control room. It is interesting to note that these hard surfaces are not flat, but divided up into narrow inclined sections which fit together in obtuse V angles. This is done to obtain an even dispersal of all sound frequencies, thus avoiding distressing peaks at resonant frequencies.

As is the common practice in American broadcasting, each studio has its own control room, the output of which goes to a centrally located master control room on the sixth floor, whence it is routed over wires to the local transmitters and to the rest of the nation-wide networks. Like the studios, the master control room is visible to the public through glass windows.

Also on the sixth floor, in addition to master control, are the main equipment room, the power room, the battery room, technical laboratory, operating and maintenance shops, telegraph and traffic rooms for communication with network stations, and the switching booths, which look like an automatic telephone exchange and contain 400 panels.

Delayed Speech Effects

A special control room has been installed for use in so-called "special events" programmes, where various parts of the broadcast may come from planes, foreign countries, ships, or pack-transmitters carried on the backs of announcers. Such complicated programmes are by no means rare in America.

Up to the present, America has not set much store by the so-called "echo chambers" developed by the B.B.C. some years ago. According to Mr. Hanson, however, Radio City is going to go one better than the B.B.C. in this respect. In addition to the mechanical control which is possible by adjustment within the echo room (adjustment of the acoustics of the room and of the distance between the loud speaker and the microphone), N.B.C. proposes at Radio City to control the period of reverberation, or echo, by means of a controllable delay circuit. In addition to this control there will be a gain control for the echo pick-up mike. Thus, the echo may be fed into the programme at any desired volume level, and with any degree of delay, or reverberation. A performance coming from a small studio could thus be made to sound as if it were coming from the vastness of an empty Olympia.

In addition to the thirty-five studios there are numerous "green-rooms" and dressing-rooms for the artists, lounges, reception rooms, musicians' rest rooms and locker rooms, storage lockers for musical instruments, sound effects, and other props, and the executive offices of the N.B.C.

UNBIASED

By FREE GRID**Gold Standard**

MANY and varied are the stunts employed by commercial concerns in the interests of publicity, and for the most part they are commendably cute. If ever there was a trade which should be in the van of progress in this matter, it should be the radio one, but what are we to think when leading members of it allow their publicity agents to churn out such hoary old tales as that of the man who turns up at a certain showroom or exhibition stand and pays for his purchase in golden sovereigns?

The tale, like that of Alfred and the cakes, is quite a pretty one, and, personally speaking, I swallowed it readily enough when it first appeared at the Motor Show a few years back. On that occasion, however, it at least had the merit of novelty.

I must confess, however, that the publicity merchant who has just trotted it out again has been distinctly original in using the farmer as the central figure in the story. If he really thinks that a farmer is such a fool as to pay over thirty pounds

delight by her fellow-women. I have been so impressed by the hostility shown by the womenfolk of my own home circle that I am wondering if my readers have had a similar experience, and should be glad to hear from them about it so that we could compare notes.

Comparisons are Odorous

IT is said that comparisons are always odious, but that will not deter me from making them in the case of the two great provincial radio shows at Glasgow and Manchester. I think, however, that "odorous" would be a more appropriate word than "odious" in this case, since Manchester insists on holding the show in a disused market place in a noisome back street, whereas Glasgow provides a fine modern hall, which is large, commodious, of no mean architectural beauty, and situated in one of the main thoroughfares of the city. In addition, the arrangements for attending to the inner man are infinitely superior.

This having been said in favour of the Glasgow show, there is, however, nothing more to add. Manchester was far and away the better show of the two, if only for the fact that manufacturers themselves exhibited there in almost as large numbers as at Olympia instead of leaving much of it to the local agents, as seemed to be the case in the Scottish city. Apart from this, the interest shown by the immediate natives and those from neighbouring kraals is far greater in the case of the city of smoke and shawls. They are not only far keener on home construction ("Nobbut the best, lad"), but possess far greater technical knowledge.

Cruelty to Guinea Pigs

I SEE that a group of American scientists has issued a statement to the effect that it is only a question of time before wireless waves have the effect of turning human beings into half-wits. They base their startling announcement on the results of experiments carried out on certain guinea pigs whose brain tissues have been definitely damaged as the result of being kept in the studio of a certain New York station.

Personally speaking, I am of the opinion that it is not the wireless waves which have turned the guinea pigs into half-wits, but the effect of some of the programmes. Indeed, I consider it a waste of time to have conducted the experiments on the unfortunate guinea pigs, as surely the same deductions could have been made by examining the brain tissues of certain performers who, judging by their efforts at the microphone, seem to have progressed a long way beyond the half-wit stage.

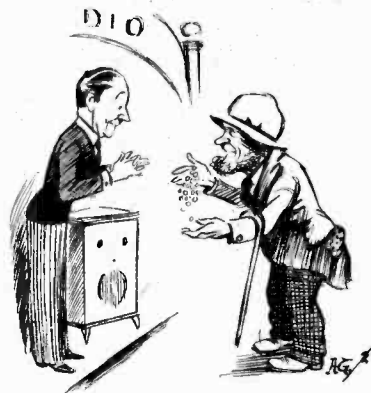

A pretty tale.

for a twenty-guinea article, then it is high time that he spent a week on a farm. It is obvious, I think, that in rehashing this threadbare publicity stunt, he had forgotten that we had departed from the gold standard since the tale was last employed. Better luck next time.

The Voice that Soothes

I AM considerably astonished at the practically unanimous verdict which has been given by women against the lady announcer who still delights the hearts of male listeners. At least it is my experience that the verdict is an adverse one, all the females numbered among my acquaintance seeming to dislike the innovation wholeheartedly.

It is totally incomprehensible to me, for I should have thought that the appearance of a woman in a position hitherto sacrosanct to men would have been hailed with

The Crystal Cell

A New Light Modulator for Television

By ERNEST H. TRAUB

WITH all mechanical television systems there has always been the same persistent demand for more light. Among the hitherto known light sources the neon lamp is the most common. Whilst it has the undoubted advantage that it is easy to modulate, the light efficiency is inadequate for modern television receivers, where only a small fraction of the light can be used. Mercury and sodium lamps are brighter and give a more pleasant colour, but fail to follow frequencies over 50,000 cycles. The Kerr cell, on the other hand, gives quite good light, although the actual efficiency is poor. It is, moreover, difficult to modulate with ordinary output voltages, and its characteristic is not linear so that it does not produce true black and white gradation.

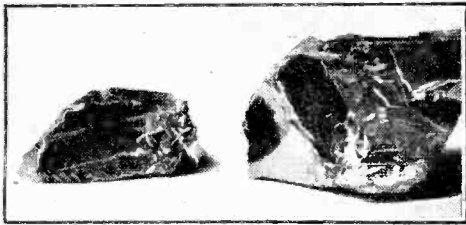

Fig. 1.—Zinc sulphide crystal in its natural form.

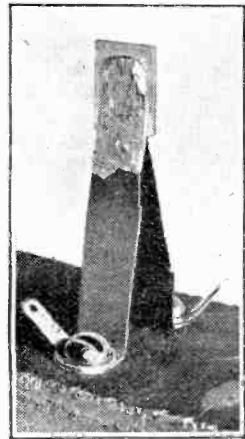
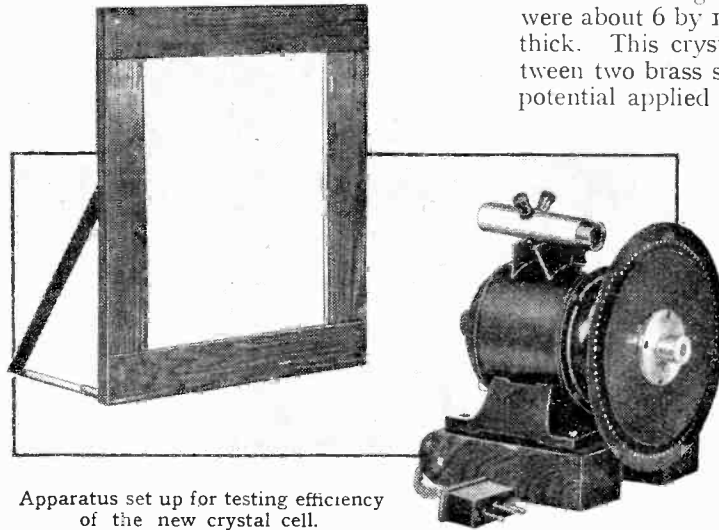

Fig. 2.—Cut and ground crystal placed between metal conductors.

Working systematically on the lines indicated above, von Okolicsanyi, a well-known Hungarian television investigator, who is best known for his Mirror Screw scanner, searched for a light valve that would, in addition to the properties outlined above, fulfil the further demands



Apparatus set up for testing efficiency of the new crystal cell.

that it should be cheap to produce, easy to handle and require no attention. This brought him to the conclusion that the substance needed should be a solid with a high Kerr constant and of great durability in order to avoid the inconvenience of liquids such as nitro-benzol. The solid must be sufficiently hard, but yet be easy to cut and polish. Lastly, the substance must be as clear as water and perfectly transparent.

Nature of the Crystal

Okolicsanyi, therefore, continued his search among *inorganic crystals*, and tested many of these for electrical double refraction. This is known to occur to some degree in quartz, tourmalin and sodium chloride crystals. Electrical double refraction is a secondary effect in which the light is influenced indirectly by the electric field, i.e., through a dielectric. The static field directs the molecules of the crystal, according to the field strength, increasing or decreasing the angle of rotation in the polarised plane proportionately. It was found that such an effect was confined to cubic crystals, which could in turn be divided into two groups: the regular rock salt type, and the acentric group, in which the eventual solution of the problem was found, namely, the *zinc sulphide crystal* (Fig. 1).

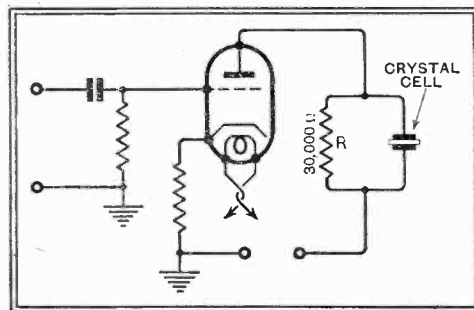

Fig. 3.—The circuit employed with the crystal cell.

For experimental purposes a small plate of crystal such as shown in Fig. 2 was cut and ground. The dimensions were about 6 by 10 millimetres and 1 mm. thick. This crystal plate was placed between two brass springs and the electrical potential applied to the two terminals, as shown.

The crystal was then placed between two crossed Nicol prisms, and set up in a television receiver. To the great joy of the inventor a perfectly good bright image appeared, which seemed to him to fulfil the demands of an ideal light valve.

For commercial use the whole light valve is set up in a metal tube about 4 inches long, which contains the crystal, the Nicol prisms and two concentrating lenses. To prove the absolute superiority of the crystal cell, a receiver was constructed using a 90 hole Nipkow disc, which is optically the least efficient of all scanners. The disc is of 10 inches diameter, the holes being only one-tenth of a millimetre square. Using only a small 30 watt lamp as the light source an image was projected on to a ground-glass screen, as shown in the photograph, the size being about one foot square.

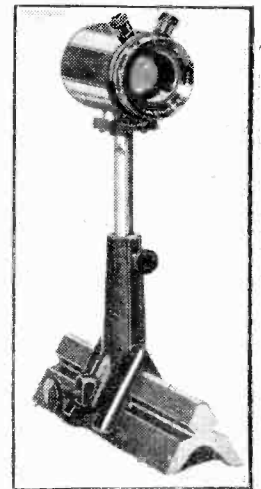

Fig. 4.—The crystal mounted between Nicol prisms. The two terminals are for the applied potential across the crystal.

Advantages claimed for the crystal cell over the ordinary nitro-benzol Kerr cell are:—

- (1) Solid, therefore no evaporation or smell as in the case of nitro-benzol.
- (2) Smaller, thus allowing the whole electro-optical system to be built into a single unit.
- (3) Better light efficiency due to closer spacing of Nicols and crystal. Efficiency about 35 per cent. compared with 10 per cent.
- (4) Infinite durability.
- (5) Linear characteristic.
- (6) Smaller capacity, requiring as a result only one-tenth of the power needed with the nitro-benzol cell. As the cell can be placed directly in the anode circuit of the output valve a resistance of only 30,000 ohms is required (Fig. 3). The potential is about 400 volts, so that

The Crystal Cell.—

the power needed can be calculated at about 5 watts. This figure can be obtained with any powerful mains receiver.

The circuit arrangement employed is shown in Fig. 3. Okolicsanyi has therefore succeeded in finding a light valve that is suitable for any mechanical television receiver where a concentrated source of modulated light is required. This light source is more efficient in all respects than any other one previously known.

It is, moreover, absolutely without lag. It is stated that measurements have been made, when it was found that the frequency curve shows no sign of falling off even at 350,000 cycles!

Even though the new cell is ideal for home television receivers from a technical point of view, the price is a further important factor in its favour. The price of the complete electro-optical unit, as shown in Fig. 4, is stated by the inventor to be under £5.

DISTANT RECEPTION NOTES

Wavelength Wanderings of Small Stations

A CORRESPONDENT who writes from Stourbridge tells me that he suffers from a considerable amount of noise interference when listening to the Midland National on 1554.4 metres. He asks whether I can tell him where it comes from. I am afraid that I cannot, for I have not noticed any such interference for a very long time in my own locality. Possibly some other reader may be able to supply the information.

It occurs to me that the interference may possibly be a harmonic of a commercial station working on about 3,100 metres. These harmonics can be troublesome at times, and often they are much worse in some localities than in others.

A week or two ago I mentioned that the station interfering with Huizen was a Roumanian. I have since learnt that it is Brasov, which, under the Lucerne plan, will have the exclusive use of the 1,875-metre wavelength. Apparently it is putting in a little practice beforehand! When the Plan comes into force, Huizen is allotted a wavelength of 1,345 metres to be shared with the Russian station Kharkov.

Readers should note, by the way, that Huizen and Hilversum have now made their quarterly exchange once more, so that Huizen is genuinely Huizen on 1,875 metres, and Hilversum genuinely Hilversum on 296.1 metres.

Medium Waveband Jumble

An instance of what even one small station can do in the way of causing interference is to be found nowadays on the band of wavelengths that lies between Rome's 441 metres and Beromünster's 459 metres. This small patch contains nominally two common-wave channels on 453.2 and 447.1 metres respectively. Recently Radio Agen has taken to working a fraction of a kilocycle above its normal frequency. In an attempt at self-defence, several of the numerous stations using the 453.2-metre channel have made slight wavelength changes, and this has caused similar changes to be made in the other common-wave channel. The net result is one of the most priceless jumbles that has ever been heard on the medium waveband.

Atmospherics were very bad for some little time whilst the weather was making up its mind about breaking after the long dry spell. Once the rain came there was a big improvement. I have no doubt, too, that the rain will have another beneficial effect in many instances. Not a few listeners bury their earth connections in chalky or gravelly soil instead of going down the extra few inches required to reach the heavier sub-soil. These have doubtless

found a considerable increase in all-round signal strength recently owing to the moistening of the soil.

The 60-kilowatt Mühlacker station does not yet seem to have closed down, for the programmes are still strongly received. Is it a case of business as usual during alterations?

On the long waves, Radio-Paris, Warsaw, Luxembourg, and Oslo are the best stations at the moment. Huizen is excellent on nights when Brasov is silent, but Kalundborg is seldom free from the unwelcome accompaniment of Monte Ceneri. Zeesen varies greatly from day to day.

Excellent reception of a large number of stations is now possible on the medium waveband, though there are many which are affected by occasional heterodynes due to wavelength wandering on the part of small stations. The best of the stations on this band are Budapest, Florence, Prague, Langenberg, Beromünster, Rome, Katowice, Toulouse, Midi, Leipzig, Strasbourg, Poste Parisien, Hilversum, Heilsberg, and Nürnberg.

D. EXER.

FOREIGN BROADCAST GUIDE

FECAMP

(FRANCE).

Geographical position: 49° 45' N.; 0° 23' E.

Approximate airline from London: 114 miles.

Wavelength: 225.9 m. Frequency: 1,328 kcs.

Power: 10 kw.

Standard time: Greenwich Mean Time.

Standard Daily Transmissions.

Week Days: English concerts, 11.00; 11.30; 16.30. Children's Corner: 17.30; 22.30. French concerts: 12.00; 12.45; 18.00; 20.30. English News Bulletin: 00.05. Latest French News: 01.00. Dance Music: 01.15.

Sundays: Continuous sponsored programmes for British listeners and French wireless entertainments from 11.00 until 01.30.

Announcers: Man and woman.

Call: *Ici Radio Normandie* (also in English at certain periods of the day and night).

Opening Signal: For French broadcasts: (song) *Nos Vieux Pommiers* (gramophone record); for English transmissions: a fanfare of trumpets.

Interval Signal: Bell (irregular).

Time Signal: Carillon and chimes from the old Benedictine Monastery at Fécamp.

Closes down as other French stations with good-night greetings followed by popular local song: *Ma Normandie*. At the end of the English broadcasts the I.B.C. good-night melody is played.

BEHIND THE SCENES

"Down-Hearted" Delegates at Amsterdam

By Our Special Representative

DELEGATES representing the broadcasting organisations of twenty-four European countries were present at the International Broadcasting Union's meeting at Amsterdam which was held from October 4th to the 12th. In addition, a number of countries sent Government representatives, drawn from the postal administrations, to act as "observers," some of these coming from as far afield as Algeria and Turkey.

Strict secrecy was observed until an official communiqué was issued on Thursday, October 12th. The main aim of the Amsterdam Conference, according to the communiqué, had been to devise ways and means of putting the Lucerne Plan into practice with the least possible disturbance to listeners. This difficult task was not made easier by the fact that certain Governments had still refrained from signing the Convention. However, according to the communiqué, the difficulties are confined to the long waveband, and even here the hope was held out that a *modus vivendi* could be arrived at by reason of the fact that certain of the stations scheduled in the Lucerne Plan would not be operating on January 15th, when the Plan comes into effect.

According to the communiqué certain technical decisions have been arrived at which are being communicated to the Governments, and investigations have been made to see whether the wavelength problem can be settled on a technical basis. For instance, the Union is considering the use of anti-fading aerials and the synchronisation of transmitters.

I am able to state that the Amsterdam Conference decided only after long discussion *not* to alter the Lucerne Plan, a decision which was rejected point blank by the Russian delegates, who declared that the whole of that country's wave distribution had been rearranged and could not, therefore, comply with the Lucerne Plan.

Holland, one of the eight non-signatories to the Plan, has consulted international law experts on the question of the retention of its long wavelength. It is considered that the International Court at the Hague will probably agree to arbitrate on whether Holland should be required to sacrifice this wave in accordance with the Lucerne Plan.

All that was effected at Amsterdam, it would appear, was an agreement among the technical experts regarding certain modifications in the Lucerne distribution of the long waves, the new aim being to take advantage of the fact that not all the claimants will be working when the scheme comes into operation. *What will happen when they are all ready to transmit is not explained.*

Despite Government modifications, it appears that the medium waves will be "all right," an opinion which can only be confirmed, or otherwise, at midnight on January 15th, 1934.

The delegates at Amsterdam appeared to be downhearted, and the conviction grew that the meeting, to no small extent, had been a waste of time and money, even if the medium waves are "all right." For the question of Luxembourg was left untouched, and Luxembourg, with its 200 kilowatts, may easily wreck whatever frail arrangement is arrived at for the distribution of the long waves!

BROADCAST BREVITIES

By Our Special Correspondent

Plenty of Time, Gentlemen

IN bars and places where they drink there has been uncalled-for alarm over the recent Court decision that the Performing Right Society can claim against those who rediffuse copyright music by loud speaker in public places.

Just at the moment the Performing Right Society is enforcing no rights, for the simple reason that the tariff of annual licences has yet to be worked out.

A Mathematical Problem

It involves no light mathematical calculation to discover what is the indebtedness of the proprietor of the "Blue Pig," Little Twittering, to Sir Edward Elgar when the Enigma Variations weave their spell among the shining pump handles.

Where the "P.R.S." Steps In

Mr. Leslie Boosey, the well-known music publisher, and chairman of the Performing Right Society, assured me last week that the public need not imagine that the Society has any idea of "frightening people."

"When the tariff has been worked out," Mr. Boosey told me, "we shall then be prepared to come to terms with all who wish to avail themselves of the Society's licence."

What the Society Does

I was surprised to learn that the "P.R.S.," as it is familiarly called, was formed only after nearly all the countries of Europe already had organisations of the kind.

These societies exist for the purpose of collecting fees due to publishers, composers, and other proprietors of copyright works who would never individually be able to secure their just dues because of the multiplicity of performers and performances all over the world.

How the Scheme Works

If, for example, Mr. Alphonso Blank, of Balham, composes a minuet which is broadcast from Brno, the local "P.R.S." notifies the British organisation, which then collects the fee due to Mr. Alphonso Blank and hands it to the composer.

All this is on the assumption, of course, that Mr. Blank is a member of the "P.R.S."

Exempt

One last word on this important subject. The Performing Right Society has no intention of extracting fees from wireless dealers, charity bazaar organisers, or street musicians.

"If we did, we should be making a rope for our own necks," said Mr. Boosey.

Home of Mystery

I APOLOGISE to readers for missing the bull's-eye last week when I said that the B.B.C. were negotiating for the Small Queen's Hall as a vaudeville studio to succeed "No. 10." Actually, the Corporation has gone next door and taken a short lease

of St. George's Hall, the Maskelyne Home of Mystery.

The first vaudeville show from the new "studio" may be expected in about a fortnight's time.

Pitfalls?

Mr. Maschwitz's Eight Step Sisters have been told to tread lightly on account of the peculiar nature of the building. The stage is alive with trap doors and quick-vanishing gadgets, and even the announcers will have to watch their pockets.

It would be highly inconvenient during the reading of the news bulletin to feel for one's handkerchief and withdraw a rabbit instead.

Big Plans for Maida Vale

In the meantime, the B.B.C. is still negotiating for those immense premises in Delaware Road, Maida Vale, in the hope of transforming the place into a permanent vaudeville studio.

In all probability the old skating rink will require to be rebuilt. The B.B.C. may take advantage of this fact to add extra floors in order to provide one large hall in addition to a restaurant, green rooms, and a certain amount of office accommodation.

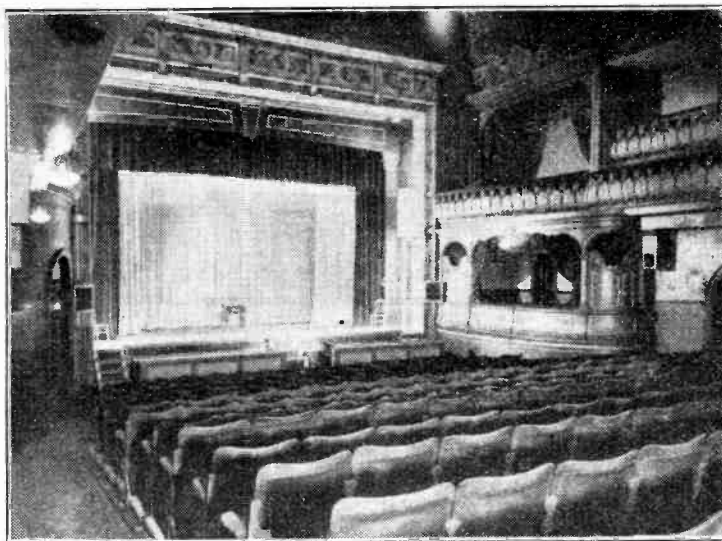

THE NEW B.B.C. "STUDIO." A recent view of St. George's Hall, long famous as the Maskelyne Theatre of Mystery. It will fill a new role towards the end of this month when the B.B.C. takes it over on a short lease as the successor to "No. 10," the wharf studio beside Waterloo Bridge. St. George's Hall is small and should prove excellent for vaudeville broadcasts.

"Circus Princess" in the Concert Hall

IN the broadcast performance of Kalman's operetta, "The Circus Princess" (October 26th and 27th), the leading part will be played by John Hendrick. Although he has been given a number of broadcast engagements, this will be his first "star" part. The Princess will be Harriet Bennet, never yet heard in England, but the possessor of a big reputation in America and Australia, where she has sung "Rose Marie" for two years. The Variety Director has decided to use the Concert Hall at Broadcasting House for the "Circus Princess," as he did for one previous musical play, namely, "Waltz Time."

What the Organ Can Do

MR. J. I. TAYLOR'S programme of improvisations on the organ at Broadcasting House last month will be recalled as a remarkable demonstration of the capabilities of this instrument when one of its creators is at the console. On November 5th Mr. Taylor is to give further improvisations: his programme will last half an hour.

A Hint to the B.B.C.

IT is to be hoped that the B.B.C. will not abandon the 30-line television tests when the Baird agreement ends on March 31st next.

By all means let us have the 120- and 180-line tests which Electrical and Musical Industries are to broadcast from Portland Place, but it would be a pity if members of the public with the older type of gear were left without any transmissions to work upon.

High Definition Tests

The high definition tests will start almost immediately, but it is emphasised that these are intended primarily for engineers and experimenters.

The first series of tests will be with apparatus installed by Baird Television, Ltd., and will go on to the end of the year. The second series of tests, beginning in January, will be with the apparatus of Electric and Musical Industries, Ltd., which was demonstrated to the B.B.C. in December, 1932.

Put on Record

THERE is always a peculiar relish about the repetition of a likeable programme, especially when the listener can hold his own "command performance" on the gramophone. The Columbia Graphophone Co., Ltd., took an enterprising step last Saturday when "C. B. Cochran Presents" was broadcast by the National transmitters. On the same day a record was issued of the performance by Mr. Henry Hall and the B.B.C. Dance Orchestra, and actually including Delysia, Peggy Wood, and Mary Ellis in their original numbers as they sang them in Mr. Cochran's show.

Good programmes will stand this sort of thing, and I hope the custom grows.

Mrs. Giles Borrett

NOW that the excitement concerning the B.B.C.'s lady announcer has died down, it is worth while asking why the B.B.C. refused to confirm or deny the story as it appeared in the *News-Chronicle* of Monday last.

Whenever anything unusual happens the B.B.C. officials invariably make that exasperating reply: "We have no statement to make." One could understand the retort if Broadcasting House were razed to the ground, but in the case of the woman announcer . . . ?

Delayed Speech

A New Method of Producing Echo Effects

By C. N. HICKMAN, Acoustical Research, Bell Telephone Laboratories

IN any form of speech transmission some delay is involved because a definite time is required for the transmission. This applies whether the speech travels directly through the air or, converted to electrical currents, passes over wires. In air, sound travels at a rate of about 1,100 feet per second, so that if you stood 1,100 feet from a person who was shouting to you it would be one second after a sound left his lips before it reached your ears. The speed of electrical transmission is much greater; under some conditions approaching that of light. Electrical circuits may be designed, however, to have quite an appreciable delay, and such circuits have been found very helpful at times in improving telephone communication.

Where the delay required is short, less than a hundredth of a second, electrical delay networks are economical and very satisfactory. Their cost for longer delays, however, becomes excessive, so that when delays of the magnitude of one second or more are required other means of securing them must be sought.

One method takes advantage of the relatively low velocity of sound in air. The electrical speech currents are converted to sound by a telephone receiver, and then the sound is allowed to travel in a tube long enough to bring about the delay desired. At the far end of the tube the sound is reconverted to electrical speech currents by a transmitter. Such acoustical delay circuits have been built, and used to some extent, but their size alone is sufficient to make them undesirable for most purposes.

Mechanical Delays

Another method of introducing an appreciable time of transmission is by the use of mechanical delay circuits. Such a delay circuit has been demonstrated by Mr. S. P. Grace in America in many talks, and consists of a long coiled spring suspended from its two ends. In this case the electrical speech currents are converted into mechanical vibrations which pass along the coiled spring at a relatively low speed, and are reconverted into electrical currents at the distant end. This method also has certain objectionable features which make it unsatisfactory for general application.

Still another method of obtaining delay, where the actual time introduced may be

of almost any long duration, with equal facility, is to record the sound either on a photographic film or on a wax disc, and to reproduce it from the record after the desired delay period. This method is ordinarily looked upon as storing rather than delaying because there is no transmission time involved. The overall effect is the same, however, and where very long delays are required the method is very useful.

The New System

So far, therefore, there are very satisfactory methods of securing delays of very short duration and of very long duration. Until recently, however, there has not been any very satisfactory method applic-

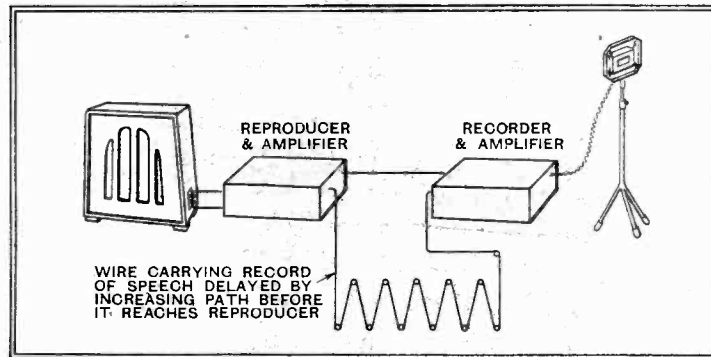

Schematic diagram to illustrate the new process. Any delay required can be obtained by altering the length of the recording wire loop.

able to the intermediate field. Although photographic or disc recording would meet the electrical requirements, the amount of apparatus required is rather more than is desirable. A method has recently been developed by Bell Telephone Laboratories in America, however, by which delays of any value from a fraction of a second to several minutes, or even more, if necessary, may be obtained by the use of apparatus very simple to set up.

Like the photographic and disc method, it is essentially a recording and reproduction, but requires no intermediate process. It utilizes the principle of magnetic recording suggested by Poulsen over thirty years ago. A thin steel tape is passed between the poles of a pair of small electromagnets at a speed of about one foot per second. The speech current is flowing through the windings of these magnets, and producing a varying magnetisation in the steel tape which corresponds to the speech current. At a short distance from these recording magnets, depending on the delay to be

HERE is an interesting description of a new method of producing a delay in speech and other transmissions. The scheme is suitable for producing echo and other effects so often required in broadcasting and in the theatre.

secured, is a second and exactly similar set of magnets. As the steel ribbon, already magnetised in conformity with the voice currents, passes between the poles of this second set of magnets, it induces voice currents in their windings corresponding to the magnetic pattern and thus to the original voice currents. In the circuit of the second set of magnets there are thus voice currents practically identical with those in the circuit of the first set, but following them after a number of seconds equal to the distance between the magnets in feet.

One of the great advantages of this method, in addition to the smallness and simplicity of the equipment, is that the magnetism in the tape may be completely removed by passing the tape through a strong unvarying magnetic field. A set of magnets for eliminating the speech record from the tape is mounted just beside the recording magnets. This enables the same piece of tape to be used over and over again. By making the tape in the form of a loop, long enough to produce the required delay, the speech may

be recorded on the tape, delayed the required interval, and then reproduced. After this the record will be wiped out by the restoring magnets, and this process can be repeated indefinitely. Photographic or disc methods do not lend themselves so readily to this continual re-recording.

Creating an Echo

At an exhibition in Chicago a concealed microphone was in a position where visitors could speak to observe the echo, connected to the circuit of the recording magnet. Hidden in the wall some distance away was a loud speaker associated with the reproducing magnets. Two seconds after a visitor had spoken a few words into the microphone the loud speaker repeated them to him. The effect was like that of an echo from a cliff a thousand feet away, except that the sound returned not only increased rather than diminished in strength but also without appreciable distortion, whereas in the usual echo effects the distortion may make speech unintelligible.

At the Motor Show

Car Radio Sets Again in the Limelight

ALTHOUGH the Olympia Motor Show has not—as yet—become a subsidiary wireless exhibition, radio equipment for cars is very much in evidence at this year's show. Even when no set is actually fitted, provision is sometimes made for it; for instance, all the 1934 saloon models produced by the Hillman and Humber concerns are supplied ready equipped with concealed roof aerials and a spare pair of power loads. This applies even to the low-priced Hillman Minx. Similarly, M.G. saloon cars are fitted with aerials, and a standard Philco set is installed on the M.G. Magnette.

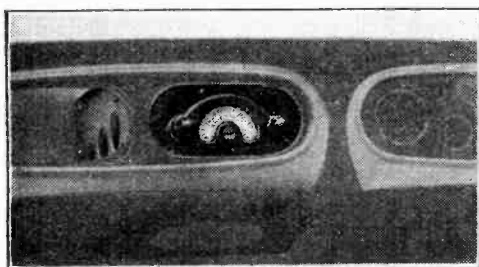

An Ekco Superhet on the instrument board of an Austin Sixteen.

A British-made Ekco receiver is to be seen on the Austin stand, where it is very neatly installed on the instrument board of a "Sixteen," and is also in evidence on stands occupied by coachbuilders. Hudson-Essex were exhibiting a Majestic receiver, which can be fitted in the Sedan de Luxe models of the Terraplane Big Six or Eight.

As for the sets themselves, those at present available in this country may be divided into two main categories. First we have a

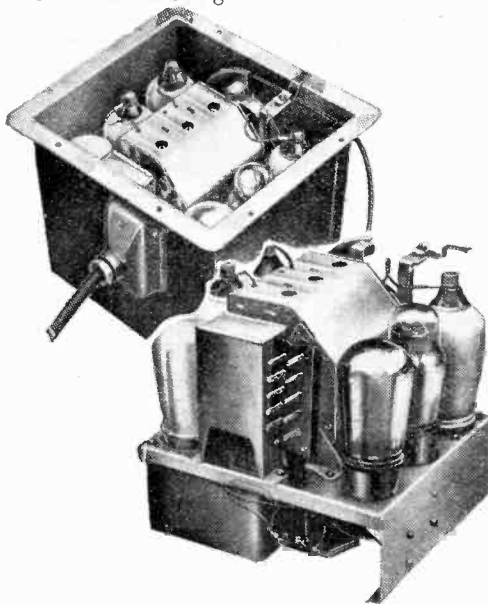

The Lissen receiver in its case, and (below) the bare chassis.

set that is intended to be directly controlled, and must therefore be so mounted that the tuning knobs, etc., are within reach of the operator's hand. This means that the choice of position is limited, but there are, of course, other compensating advantages. Remotely controlled sets, in which the tuning condenser, etc., is operated through a

Bowden wire or similar mechanism, may be installed in almost any position, especially when the loud speaker is supplied as a separate unit. In some of the newer sets there is a tendency to mount the loud speaker in the receiver itself.

One of the best known of the directly controlled car sets is the Ekco model, which was exhibited at the Radio Show. This is a compact version of the Type 74, and embodies a superheterodyne circuit with automatic volume control. Valve heaters are fed from the car battery, which also supplies anode current through a rotary converter. As yet, the Ekco receiver is only available for motor manufacturers.

The Sunbeam Midget, described in our Olympia Show number, has just made its appearance, in a slightly modified form, as a directly controlled car set, at the extremely attractive price of seven guineas only. A straight four-valve circuit, with one H.F. stage, a screen grid detector, inter-

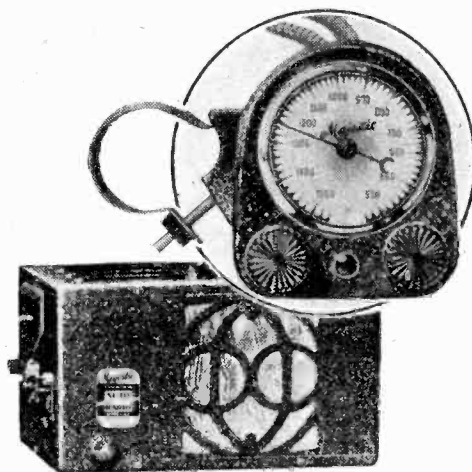

Majestic car set and remote control unit.

mediate L.F. amplifier, and pentode output is employed. The speaker is housed in the set, which is consequently self-contained, except for the H.T. supply system. Anode current may be derived either from a 99-volt dry battery or from a generator.

The larger remotely controlled Philco "Transitone" set, with loud speaker and H.T. generator as separate units, is retained, but a somewhat less ambitious set has recently been introduced. This model has a four-valve superheterodyne circuit with A.V.C.; anode current is derived from the car battery through a vibratory transformer device, and is rectified by a fifth valve. Both the H.T. generator and the loud speaker are mounted in the set.

The technical features of the five-valve superheterodyne (with Westector A.V.C.) made by Page Car Radio have already been described in this journal. Remote control and a separate speaker unit are provided; apart from this set, the firm specialises in car radio equipment generally, including the suppression of interference.

A "straight" circuit with three H.F. stages and Class "B" output is used in the Lissen receiver, which also covers both wavebands and derives its H.T. either from a battery or a generator. The three units comprising the equipment are the set proper,

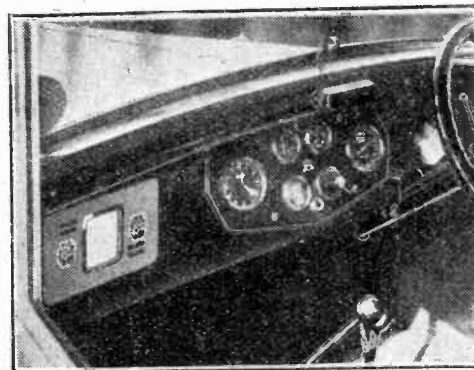

The Sunbeam directly-controlled receiver.

the loud speaker, and a particularly convenient control device on the steering column. Lissen sets were seen on Chrysler and Dodge cars at Olympia, and are also fitted on Ford cars at the Albert Hall, where demonstrations are being given.

In the Majestic Superheterodyne a total of six valves, including a rectifier, are employed. Almost as a matter of course in this class of set, automatic volume control is employed, while the single-valve frequency changer is of the Pentagrid type, a double-diode-triode being employed as a second detector. The high tension generator is of the vibratory type, and, with the loud speaker, is included in the set.

Another five-valve superheterodyne, the Peerless, employs a screened pentode as a combined detector-oscillator, and embodies a total of five tuned circuits. An energised loud speaker and a vibratory H.T. generator are, again, fitted in the receiver itself. The same firm produces a six-valve model.

Naturally, everyone who installs a car radio set of the type under discussion will expect that it should be capable of functioning while the vehicle is in motion. It is therefore necessary to take steps to prevent interference from the electrical equipment of the car. This interference will generally yield to fairly simple treatment, but suppressor resistances are always required.

A number of firms are now producing special equipment for this purpose. Resist-

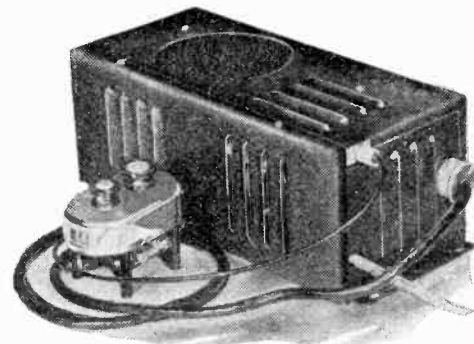

The complete Peerless receiver.

ances of suitable design, and in a form which makes it easy to attach them to the plugs, are available from Erie, Dubilier, Rothermel, etc., while T.C.C. produces a special design of by-pass condenser. As an alternative to the use of plug resistors, special Champion plugs, with built-in resistors, may be used.

Rotary converters, wound for both 6-volt and 12-volt inputs, and delivering more than sufficient H.T. output for any car set, are now produced by the Electro-dynamic and M-L concerns.

Letters to the Editor:—

The Photo-Electric Gramophone

Double-channel Transmission : Empire Receivers : Filter Design

The Editor does not hold himself responsible for the opinions of his correspondents

The Photo-Electric Gramophone

MAY I use your columns to ask a very pertinent question: where is the photo-electric gramophone? As long ago as February 4th, 1931, an instrument called a "Selenophone" was described in *The Wireless World*, but neither this nor any other form of photo-electric reproducer for home use seems to have come upon the market. Yet the photo-electric "sound head" of one sort or another is used on every talking film projector, and the Blattnerphone-Stillé apparatus is operated daily by the B.B.C. Why, then, do the big gramophone combines still limit the home consumer to the old-fashioned and inefficient disc for his "potted music?"

Much misplaced ingenuity has been wasted on designing automatic record changers, but such mechanisms are only palliatives, and remarkably poor ones, for the deep-seated disease of the disc reproducer, namely, the inability to play any but the shortest pieces of music through without interruption. Even after the recording companies have gone to the trouble of issuing special pressings of symphonies, etc., so that the wretched one-sided record changer can do its work to the best of its poor ability, there still remains the pause while the machinery whirrs and another disc drops with a thud. To anyone with the slightest musical feeling these continual breaks are simply maddening. Pauses are not tolerated in the talking picture theatre where every proprietor is forced to have at least two projectors; why should not the far greater art of music receive at least the same consideration?

I am a keen amateur of music and have studied it all my life. Of late the electric reproducer of sound has become fit for a sensitive ear to listen to. It now remains to make the gramophone into a musical instrument which will play a whole symphony or an act of an opera without any break whatever. Why have not the gramophone companies produced such an instrument? I strongly suspect them of deliberately buying up all inventions of the kind I have mentioned in order to keep them off the market. Are they afraid that they are going to lose money on the scrapping of their existing equipment? There is no need for the change to be sudden, but the change has got to come sooner or later. In the past, the gramophone companies have underrated the musical taste of the public and have hesitated to make complete recordings of standard works until private societies showed them that it could be done at a profit. Musicians have agreed that the present day reproduction is fit to bring the gramophone into the class of musical instruments; but they are already demanding more than this. Let the big companies look to it that they are not outstripped by independent enterprise. PATRICK KING, Baghdad. Flight-Lieut., R.A.F.

Correspondence should be addressed to the Editor, "The Wireless World," Dorset House, Stamford Street, S.E.1, and must be accompanied by the writer's name and address

Double-channel Transmission

MAY I raise a query in reference to double-channel transmission?

In your issue of September 29th Mr. R. B. Ransome writes happily of two separately operated speakers, side by side in the same cabinet, and your leader also refers to *two loud speakers*.

Surely, with the type of loud speaker in use nowadays, the only way to reproduce binaural hearing is by means of headphones: one receiver for each channel.

This, I confess, is the only method I have used, as the possibility of using loud speakers seems theoretically out of the question. J. J. Y. SCARLETT.

Beaconsfield.

Commercial H.F. Receivers

OWING to the fact that many parts of the tropics have A.C. mains it would appear that manufacturers might seriously consider building somewhat more ambitious receivers than heretofore, especially as regards the output which is usually 2,000 m/Watts undistorted—hardly enough when it is realised that rooms are usually larger than at home and that windows and doors are open, this latter condition having the effect of reducing the apparent volume. As to the high frequency or signal portion of the receiver, it is becoming increasingly obvious that a pre-selector stage is a *sine qua non* nowadays. Reception of Empire transmissions is, on the whole, extremely satisfactory and this, together with my experience that many people complain of receivers not being powerful enough, prompts these remarks.

E. T. SOMERSET,

Ex-G2DT.

Mombasa.



The "Utility" Home Safe is a product of the well-known firm of Wilkins & Wright. It may be used for collecting the 'instalments' for wireless purchases.

A Less Effective Filter

UNDER this heading on page 296 of your issue of October 6 we note a warning to readers against fitting less perfect forms of heterodyne-whistle, or sideband-splash filters in the new Monodial Super-heterodyne receiver. We fully endorse the view that the type of filter designed for this receiver should be adhered to by constructors, and it cannot be emphasised too strongly

that the all-too-common type of high-note attenuator consisting of a resistance-capacity combination* is vastly inferior to a properly designed filter. We hasten to assure you that our "Kinva" components are real filters, developed with the help of the latest audio-frequency test apparatus. Actual test curves are sent out with these new types, and with tests occurring at every stage of manufacture, the results indicated by these curves are guaranteed within very close limits. Readers may rest assured that not only are Kinva filters "proper" filters, but that the exceptionally steep characteristics presented this year ensure maximum filtration, with minimum quality attenuation.

p.p. POSTLETHWAITE BROS.,
A. E. Postlethwaite,
Kinver, Stourbridge.

* It was, of course, this type which was referred to.—Ed.

THE RADIO INDUSTRY

The "All Metal Way," 1934 edition, issued by the Westinghouse Brake and Saxby Signal Co., Ltd., is an even more useful and comprehensive publication than its predecessors. In addition to full technical information on the use of Westinghouse metal power rectifiers, it deals with the applications of the new "Westectors" as high-frequency detectors, A.V.C. devices, and in battery-economy circuits. Readers may obtain copies by sending 3d. in stamps to the company at 82, York Road, King's Cross, London N.1.

As the recently introduced "Avomitor" multi-range meter is such an obviously attractive accessory, it is hardly surprising to hear that the manufacturers are somewhat behind-hand with deliveries.

We are asked to tender their apologies to readers; it is hoped that the production will soon be abreast of demand.

Marconiphone announce that D.C. counterparts of their A.C. receivers, types 272 and 276, will be available on October 16th.

The 20-page "Multitone Guide to Class 'B'" deals with every aspect of the subject—historical, theoretical and practical. Free copies are available for readers interested in battery-economy circuits.

Changes of Address

E. R. Morton, Ltd., the London agents for "Utility" radio components, from Bartlett's Buildings, Holborn, to 11, Newman Street, Oxford Street, London, W.1.

Radio-Aid, Ltd., from 4, Idlesleigh House, Caxton Street, London, S.W.1, to 45, Duke Street, London, W.1.

Catalogues Received

Edison Swan Electric Co., Ltd., 155, Charing Cross Road, London, W.C.2.—Pamphlets dealing with B.T.-H. loud speakers and pick-ups; also Edison battery booklet and catalogue, the former giving much useful information on the use and maintenance of dry H.T. batteries.

Redfern's Rubber Works, Ltd., Hyde, Cheshire.—Leaflet describing panels and other articles in ebonite.

Electro Dynamic Construction Co., Ltd., Devonshire Grove, London, S.E.15.—Rotary converters, etc.

Practical HINTS and TIPS

THE simpler type of receiver is still dependent to a great extent on the use of reaction for its sensitivity; but, unfortunately, with modern detector valves operating at a high anode voltage, reaction control is not always so smooth and

Smoother Reaction

progressive as it might be. Indirectly heated A.C. valves are particularly likely to be deficient in this respect. When connected in the usual way rectification efficiency may be quite high, but the operating conditions of the grid circuit may be unsuitable for smooth reaction.

In order to avoid reaction backlash, and thus to improve overall sensitivity, a compromise may be made by applying a small negative voltage to the detector grid; this voltage can only be determined experimentally, and should be just sufficient to give smooth reaction without noticeably impairing the operation of the detector. A

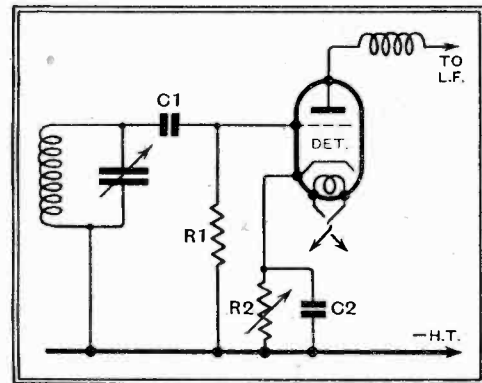

Fig. 1.—Improving reaction control by adjustment of detector-operating conditions. C1 and R1 represent the usual grid condenser and leak.

convenient way of applying this voltage is illustrated in Fig. 1; here a variable resistance, R2, of about 200 ohms is inserted in the detector cathode lead, and across it is shunted by a by-pass condenser of 1 or 2 mfd.

Constant adjustment of the resistance will not be required, and so it may be of the semi-variable variety. This method of improving reaction will be found greatly superior to the alternative of reducing detector anode voltage.

MICROPHONES designed for connection to the pick-up terminals of a receiver, in such a way that the L.F. circuits may be used as a speech-frequency amplifier, are now available from many sources. Many, if not all, of these instruments have surprisingly good characteristics, considering their cheapness, and no doubt many readers will be considering their use as "deaf-aid" appliances.

Microphone-Speaker Reaction

For the benefit of those without pre-

AIDS TO BETTER RECEPTION

vious experience of microphones and speech amplification it should, perhaps, be pointed out that acoustic reaction between microphone and loud speaker is likely to give trouble when both instruments are mounted in the same room.

Unless adequate acoustic screening can be provided it is always safest to arrange for the deaf person to listen through headphones, as the trouble can then hardly arise.

ON the medium broadcasting waveband a frequency range of roughly 1,000 kc/s is covered by the average receiver. It therefore follows that with "straight-line frequency" tuning, stations spaced from each other by 9 or 10 kc/s would be separated on a "0-100" tuning dial by almost exactly one division.

Finding Elusive Stations

Actually, modern ganged tuning condensers are not exactly "straight-line frequency," but when searching for an elusive transmission it is helpful to remember that a division will correspond roughly to a channel. With a 0-180 degree dial the spacing between channels is slightly under two degrees.

On the long broadcasting waveband, the apparent sharpness of tuning is much less, as a total frequency band of only about 150 kc/s per second is covered. This means that, allowing for 9 kc/s separation, there will be a space of about four divisions between adjacent stations on a 0-100 dial.

IN order to prevent the pick-up of hum and other forms of interference it is sometimes an advantage to run loud speaker extension leads with screened cable, the metallic shielding of which is, of course, earthed, preferably at more than one point. But it should be borne in mind that screened extension leads are bound to have a fairly high capacity, and so there is a risk that high-note loss may take place; accordingly, screening should not be used indiscriminately. It should only be employed when hum is troublesome and when the addition of screening effects a definite improvement.

Disadvantages of Screened Leads



STRICTLY speaking, the modern battery economy circuits should not be employed when mains are available; at any rate, very special precautions are necessary when the anode supply is drawn from A.C. mains through a rectifier. But, due to the better regulation of a D.C. supply, it is possible, at no very great expense or trouble, to obtain

Q.P.P. and Class "B" Eliminator

quite good results. The knowledge that this can be done is particularly likely to be useful to those who have a D.C. supply not in excess of 150 volts, and who wish to modify an existing receiver and eliminator without incurring any very great expense or trouble.

In order that the H.T. voltage on the output valve or valves may remain sensibly constant in spite of varying demands brought about by changes in modulation, it is necessary that the D.C. resistance of the smoothing system should be low. The ordinary eliminator does not satisfy this requirement, but, due to the fact that a very small amount of smoothing is needed for output stages of the type under consideration, it is easy to introduce a satisfactory modification by providing a separate smoothing system.

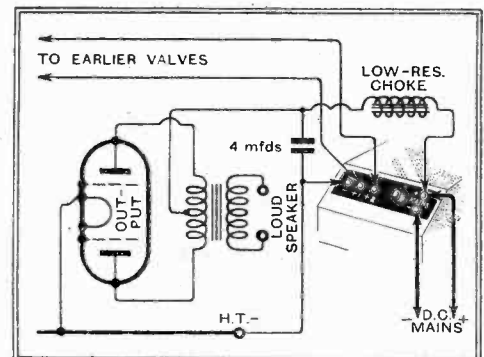

Fig. 2.—A parallel low resistance smoothing circuit for feeding a Class "B" or Q.P.P. stage. The extra choke is joined directly to the positive side of the mains.

By feeding the output stage through a "parallel" smoothing circuit external to the eliminator, as shown in Fig. 2, undesirable voltage changes are avoided. An inductance of 10 henrys, or even less, is almost always more than sufficient for the extra choke; its D.C. resistance should not amount to more than 100 or 200 ohms.

Columbia "Radiograph"

MODEL 1003



An Economical but Powerful Battery Radio-gramophone

THE possession of a full-sized cabinet radio-gramophone is the aspiration of every wireless and gramophone enthusiast. It provides the widest possible scope in entertainment value and sets the standard for volume and quality of reproduction under domestic conditions. Until recently the possession of such an instrument inferred the availability of a mains supply, and it is due to the fact that radiograms are generally of the mains-operated type that their reputation for quality performance stands so high.

A year ago, to have produced a battery-operated model with a sound output anything like comparable with its size would have been commercial suicide, for few could have afforded the cost of H.T. battery replacements. As it is, those who are not yet familiar with the possibilities of the latest battery output valves must have grave misgivings on this score when the Columbia Model 1003 is demonstrated to them for the first time. The undistorted power output is rated at 1,250 milliwatts, and owing to the efficiency of the large permanent-magnet moving-coil loud speaker installed, the sound output is, if anything, more than one would expect from this rating. Yet the measured standing H.T. consumption in the

FEATURES. *Type.*—Battery radio-gramophone with moving-coil loud speaker and double-spring motor. *Circuit.*—Variable- μ screen-grid H.F. stage with band-pass input—grid detector with reaction—quiescent push-pull pentode output valves. *Controls.*—(1) Tuning and on-off switch. (2) Waverange and gramo. switch. (3) Radio volume control. (4) Gramo. volume control. *Price.*—£21. *Makers.*—Columbia Gramophone Co., Ltd., 98-108, Clerkenwell Road, London, E.C.1.

set tested was only 6.5 mA. In no instance did the peaks in loud passages exceed 16 mA. and at full volume the average consumption was between 8 and 10 mA. Under normal listening conditions the average would be even less.

The reproduction of gramophone records is particularly good. The new Columbia No. 22 pick-up is employed and a separate volume control on the outside of the cabinet enables the lid to be kept closed during the playing of a record, with a consequent reduction in surface noise. It is worthy of note that the amplification available has been very happily matched to the pick-up output, and on the average record full volume without overloading is obtained with the control at maximum.

An important item of the specification is the silent and powerful double-spring motor. In addition to the usual friction brake and speed regulator, it is fitted with an automatic stop actuated by the tone arm.

The particular system of push-pull which has been adopted in the output stage is known as "CQA" (constant

quality amplification), and is so called because distortion is kept within the 5 per cent. limit over the full volume range of the instrument. Pentode valves are employed and accurate matching is achieved by inserting the auxiliary grid connections to the H.T. battery in sockets lettered to correspond with the markings on the valves, which are tested and classified in the factory.

The earlier stages on the radio side consist of a variable- μ screen grid amplifier and a grid detector. There are three tuned circuits and reaction is applied to the H.F. coupling transformer through a section of the radio volume control potentiometer. Selectivity is good for a receiver with a

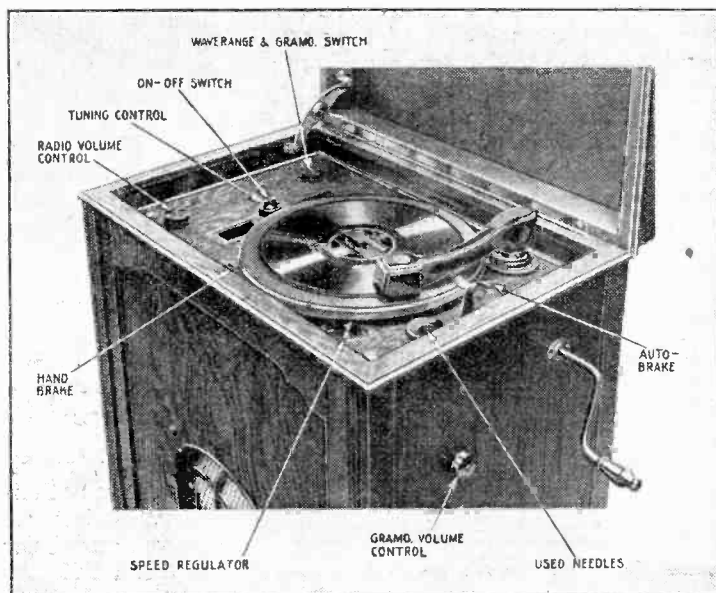

General view of motor board. Note the external gramo. volume control.

single H.F. stage, and in Central London stations separated by more than 40 kc/s from the local stations can be received without interference. The range on both wavebands is sufficient to receive all the worth-

while European programmes after dark, and many of the more powerful long-wave and medium-wave stations in daylight.

This is an instrument which can be recommended without reserve to those who are not fortunate in having supply mains available, but who require the widest possible entertainment value with the minimum upkeep cost.

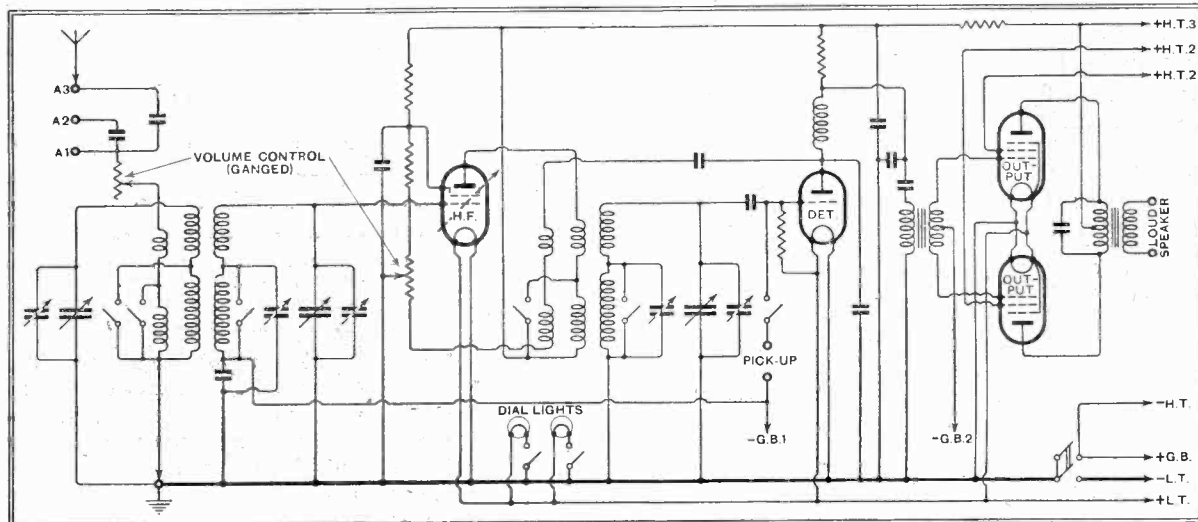

Circuit diagram of radio chassis. The output valves are matched by adjusting the auxiliary grid voltages.

NEXT WEEK'S SET REVIEW:
TELSEN "464"

NEW APPARATUS REVIEWED

Latest Products of the Manufacturers

GRAMPIAN LOUD SPEAKERS

THE type P.C.X. is a permanent magnet unit with a very pleasing balance of tone. Its sensitivity is good, and the useful frequency range is from 75 to 4,500 cycles. The bass resonance occurs at 90 cycles, but is not sharply defined, with the

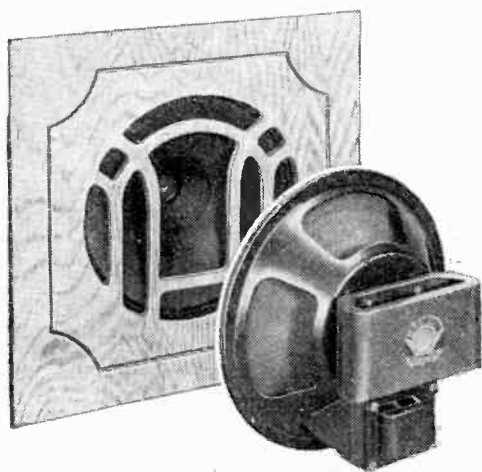

Grampian P.C.X. loud speaker and fret baffle.

result that the low-note response is full without any definite coloration. In the upper register also there are no obvious resonances to cause shrillness, but the output between 2,000 and 4,000 cycles is higher than the general level. The unit is fitted with a multi-ratio transformer suitable also for push-pull output stages, and a subsidiary plug and socket enables the unit to be used with a low-impedance extension loud speaker. The price, which includes an ornamental baffle, is 45s.

The "Owl" midget dual P.M. unit is supplied on a baffle measuring 13½ in. x 7½ in., and can be fitted into a number of standard receiver cabinets. The diaphragms are both 4½ in. in diameter, but are made of different materials in order that the frequency range may be as wide as possible. The sensitivity is slightly less than that of the P.C.X., but the reproduction has the distinctive quality associated with dual source repro-

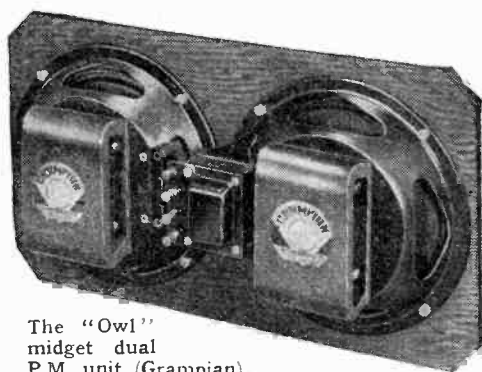

The "Owl" midget dual P.M. unit (Grampian).

ducers. In view of the small size of the diaphragm, there is a surprisingly good response below 100 cycles, and at 50 cycles the note contains very little second harmonic. There are fairly well defined resonances at 140, 2,500, and 4,500 cycles, and the response is good up to 5,500 cycles. The price is 55s., complete with multi-range output transformer, and the makers are Grampian

Reproducers, Ltd., Station Avenue, Kew Gardens, Surrey.

PILOT CLASS "B" CONVERSION KIT

WHILE the conversion of a battery set to Class "B" operation is a comparatively straightforward matter, for it entails but little alteration in the existing layout, there are many who hesitate to embark on this work in view of some uncertainty as to the choice of components and the exact manner to deal with their own particular receiver. In order to simplify this conversion the Peto Scott Co., Ltd., 77, City Road, London, E.C.1, have introduced the Pilot Class "B" Conversion Kit which is complete in every detail and includes a blue print of the wiring, also instructions for converting receivers of various types.

The kit consists of a driver transformer, seven-pin valve-holder, tapped output choke, screws, the necessary wire and a Cossor 240 B Class "B" output valve and, as mentioned already, a blue print and full instructions.

In most cases it will be found possible to accommodate the few additional components in the set, and the Class "B"

Peto Scott Pilot Class "B" Conversion Kit.



valve-holder filament connections can be wired in parallel with the L.T. wiring so that the existing battery switch operates on all valves. Where this course is not possible the parts can be assembled as a small separate unit and used external to the set. They can be accommodated on a baseboard measuring 9 in. x 4 in., and the price including valve is 37s. 6d.

NEW KINVA SCREENED H.F. CHOKE

THE latest addition to the range of Kinva screened H.F. chokes made by Postlethwaite Bros., Church Hill, Kinver, near Stourbridge, is the model I.D.C., in which is used an iron dust alloy core described as Kinvalloy. It is a general-purpose model of high inductance and low self-capacity.

The low self-capacity, which is of the order of 3 m-mfds. only, results from the use of a high-permeability core, as this enables an inductance of approximately 200,000 microhenrys to be obtained with fewer turns. The winding is well sectionalised.

During the course of our tests the only resonance of any consequence that could be

traced fell within the "no man's land" of broadcasting, being at a wavelength of 575 metres. A subsidiary resonance falling about the middle of the medium waveband was just discernible, but it has negligible effect on the tuning

Kinva iron-cored screened H.F. choke model I.D.C.



or on the efficiency of the reaction circuit.

Whether used in H.F. or detector circuits the choke will be entirely satisfactory, and at the price of 4s. 6d. it represents good value.

LOUD SPEAKER BAFFLES

THE latest directional baffles made by Scientific Supply Stores (Wireless), Ltd., 126, Newington Causeway, London, S.E.1, are designed to work in conjunction with ordinary cone diaphragm moving-coil units, and are made of waterproofed non-resonant material. The circular flange at the throat is of wood, so that the loud speaker can be readily fixed by wood screws.

There can be no doubt that a horn of this type, by virtue of its directional properties, greatly improves the efficiency of a moving coil unit, and for public address work can be usefully employed to reduce microphone pick-up.

The unit illustrated has a 7½ in. throat and 36 in. diameter flare, and the length is 33 in., and is sold at 29s. 6d. There is a wide range of alternative sizes, and the makers are prepared to undertake the construction of horns with rates of taper other than the exponential, which is standard.



Scientific Supply Stores' exponential baffle for moving-coil units.

READERS' PROBLEMS

D.C. and Battery "Monodials"

A NUMBER of readers, who have either a D.C. mains supply or are forced to depend on batteries for operation of their receivers, have asked whether suitably modified versions of the New Monodial could be described for their benefit.

It is regretted that at the present moment this is hardly practicable, for the reason that the special frequency-changing valve used in the new receiver is as yet only available in a form suitable for A.C. operation

An Ideal Country-house Set

SEVERAL prospective constructors of the D.C. Superhet. (September 29th) have enquired whether it would be possible to operate this receiver from a low-voltage house-lighting plant. It is understood, of course, that the supply voltage would be supplemented, so far as H.T. is concerned, by an accumulator battery.

valve, in series with a "dropping" resistance, is connected in parallel with the other valves.

No smoothing should be necessary with a domestic supply derived from accumulators. Of course, the resistance value shown will need modification with mains supply of high voltage, and, further, a resistance will be required in series with the $\frac{1}{4}$ -amp. valves for pressures above 50 volts.

A Matter of Choice

WE are asked to say whether it is desirable to fit a fixed or semi-fixed potentiometer for supplying the screening grid voltage of the H.F. valve in a battery-operated receiver. Our correspondent has in mind the use of an arrangement similar to that customarily employed in mains-operated sets.

Practically the only advantage of a potentiometer feed for the screening grid is that the need for a multiplicity of tappings

THESE columns are reserved for the publication of matter of general interest arising out of problems submitted by our readers. Readers requiring an individual reply to their technical questions by post are referred to "The Wireless World" Information Bureau, of which brief particulars, with the fee charged, are to be found at the foot of this page.

ratio of about 3:1, and, if so, it would be quite unsuitable in a receiver where the detector feeds directly into the output stage. This is because the maximum voltage output from a conventional detector is quite insufficient to "load up" such a stage unless it is stepped up to a considerable extent.

This handicap is, however, easily overcome by fitting an intermediate L.F. stage between the detector and output valves; if it is desired to use the existing transformer we recommend this plan, which, indeed, has much in its favour.

Anode Current Fluctuations

A READER, who always uses a milliammeter in the anode circuit of his detector valve as a tuning indicator, writes to us regarding the changes in current that he has observed. With his present receiver the meter shows a reduction of current of nearly 1 milliamp. when the set is tuned to a moderately powerful transmission, whereas with an earlier set a change of as much as a $\frac{1}{4}$ -milliamp. could hardly be obtained as a result of tuning-in even the local station.

The question of anode current changes under the influence of incoming signals is bound up with the subject of detector design. Modern detectors are designed to give a comparatively large undistorted output; indeed, it is in most cases essential that they should do so, as they must operate the output valve without the help of an intermediate L.F. stage. Consequently, a large change in anode current is to be expected. In the older set referred to an intermediate stage was probably included, and so the maximum output required from the detector was presumably much less.

A detector anode current change approaching 1 milliamp. is by no means excessive nowadays, and does not indicate that the valve is being overloaded.

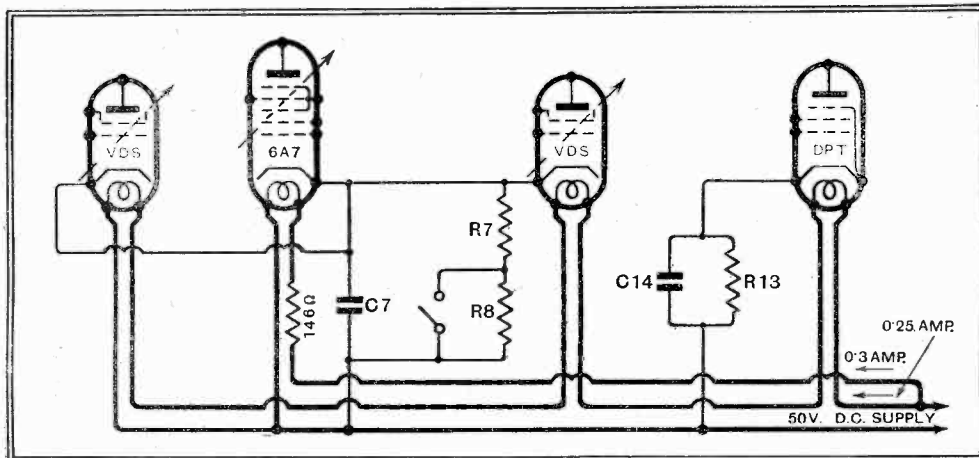

Fig. 1.—Rearrangement of the D.C. Superhet heating circuits for a 50-volt D.C. supply.

With regard to the supply of the filament circuit from a low-voltage source—say, 50 volts, for example—no difficulty should be encountered, and it is suggested that the wiring should be carried out in the manner shown in Fig. 1. The heaters are in series-parallel; the three 16-volt $\frac{1}{4}$ -amp. valves are in series, and, as the total voltage dissipated across them amounts practically to that of the mains, no series resistance will be required. The 6A7 detector-oscillator

on the H.T. battery is avoided. With this potentiometer, and with suitable feed resistance for the anode circuits of all valves requiring less than the maximum voltage, only two connections to the battery would be needed.

On the other side of the picture we have the disadvantages that the potentiometer will consume an appreciable amount of current while the set is working, and that switching must be complicated by the provision for means to prevent the flow of current when it is out of use. Further, in order to ensure good regulation, especially when a variable- μ valve is used, it would be necessary to arrange the potentiometer value so that the total current consumed by it reaches an appreciable value.

Transformers for Q.P.P.

A QUERIST, who has an ordinary push-pull L.F. transformer—several years old, but of good make—asks whether it would be possible to use this component in a Q.P.P. amplifier.

In theory there is no basic difference between a push-pull and a Q.P.P. transformer, but in practice the latter almost always has a much higher step-up ratio. We expect that our correspondent's transformer has a

BOOKS RECEIVED

A Guide to Amateur Radio.—A series of simple articles intended to provide an introduction to amateur radio work, and outlining the advantages to be gained through membership of the R.S.G.B. The subjects include an explanation of the elementary principles of transmission and reception, the construction of a short-wave transmitter and receiver, aerial systems, power supply, frequency measurement, etc. Pp. 48, with numerous illustrations and diagrams. Published by the Incorporated Radio Society of Great Britain, 53, Victoria Street, London, S.W.1 Price 6d.

La Télévision et ses Progrès. by P. Hemardouin.—A short account of the history and progress of television, the general principles, and a description of typical apparatus, with a chapter forecasting the future progress in France, Belgium, Germany, England, and the United States. Pp. 243+xiv. with 150 illustrations and diagrams. Published by Dunod, 92, rue Bonaparte, Paris, VI. Price fcs. 29.

Bombay Radio News.—We have received from the publishers, The Bombay Radio Press, the first two numbers of this journal, whose avowed object is the popularising of wireless in India. In addition to paragraphs of local interest, it contains articles intended to interest listeners in the technical side of reception. The price of this monthly publication is 2 annas, or one rupee per annum.

The Wireless World

INFORMATION BUREAU

THE service is intended primarily for readers meeting with difficulties in the construction, adjustment, operation, or maintenance of wireless receivers described in *The Wireless World*, or those of commercial design which from time to time are reviewed in the pages of *The Wireless World*. Every endeavour will be made to deal with queries on all wireless matters, provided that they are of such a nature that they can be dealt with satisfactorily in a letter.

Communications should be addressed to *The Wireless World* Information Bureau, Dorset House, Stamford Street, London, S.E.1, and must be accompanied by a remittance of 5s. to cover the cost of the service. The enquirer's name and address should be written in block letters at the top of all communications.

The Wireless World

THE
PRACTICAL RADIO
JOURNAL
23rd Year of Publication

No. 739.

FRIDAY, OCTOBER 27TH, 1933.

Vol. XXXIII. No. 17.

Proprietors: ILIFFE & SONS LTD.

Editor:
HUGH S. POCOCK.

Editorial,
Advertising and Publishing Offices:
DORSET HOUSE, STAMFORD STREET,
LONDON, S.E.1.

Telephone: Hop 3333 (50 lines).
Telegrams: "Ethaworld, Watloo, London."

COVENTRY: Hertford Street.

Telegrams: "Cyclist, Coventry." Telephone: 5210 Coventry.

BIRMINGHAM:

Guildhall Buildings, Navigation Street, 2.

Telegrams: "Autopress, Birmingham." Telephone: 2970 Midland (3 lines).

MANCHESTER: 260, Deansgate, 3.

Telegrams: "Iliffe, Manchester." Telephone: Blackfriars 4412 (4 lines).

GLASGOW: 26B, Renfield Street, C.2.

Telegrams: "Iliffe, Glasgow." Telephone: Central 4857.

PUBLISHED WEEKLY. ENTERED AS SECOND
CLASS MATTER AT NEW YORK, N.Y.

Subscription Rates:

Home, £1 rs. 8d.; Canada, £1 rs. 8d.; other
countries abroad, £1 3s. 10d. per annum.

*As many of the circuits and apparatus described in these
pages are covered by patents, readers are advised, before
making use of them, to satisfy themselves that they would
not be infringing patents.*

CONTENTS

	Page
Editorial Comment	333
Television Explained	334
Practical Hints and Tips	336
Design for a Scratch Filter	337
By Air to the Antipodes	339
The Post Office Experimental Laboratory	341
News of the Week	342
PROGRAMMES FROM ABROAD, pp. I-XXII	
Broadcast Brevities	343
Unbiased	344
Further Notes on the New Monodial	345
Telsen "464" Set Reviewed	347
Letters to the Editor	348
New Apparatus Reviewed	349
Readers' Problems	350

EDITORIAL COMMENT

Electrical Interference Progress Towards Suppression

IMPORTANT progress is being made in the crusade inaugurated by *The Wireless World* for the suppression of electrical interference with broadcast reception.

A report just issued from the Institution of Electrical Engineers advises us that the Committee on electrical interference with broadcasting, which the Institution set up some time ago as a direct result of a suggestion from *The Wireless World*, held its second meeting on Thursday, October 5th. Elsewhere in this issue we publish a report of the progress of this Committee.

It would seem that a real advance is being made not only on the general question of how to organise for the suppression of interference but also on the more detailed consideration of the technical means to be employed with specific types of electrical apparatus.

There is only one point in connection with the activities of the Institution Committee which we feel calls for criticism. In the report just issued it is stated that "The Committee reviewed various possibilities of bringing suppression devices into general use without having recourse to legislation." If by this statement it is intended to convey that the Institution Committee hopes to attain the desired result without legislation, then we feel obliged to express the view that this would be an unsatisfactory compromise not only in the interests of the broadcast listener but more especially from the point of view of the electrical industry itself. Unless legislation is introduced so as to give the Post Office the necessary authority to compel compliance with reasonable requirements, we are bound to have the unsatisfactory state of affairs resulting where individuals or certain sections of the electrical in-

dustry may be unwilling to co-operate for the suppression of interference. This would be a gross unfairness to those who voluntarily undertook, at some inconvenience and expense to themselves, to render their equipment innocuous. The purpose of legislation would surely not be to force upon the electrical industry irksome or unreasonable regulations, but to ensure that, having agreed upon fair and reasonable measures, these would be binding upon all parties on an equal footing, and without exceptions, whether the apparatus was manufactured here or imported from abroad.

G.P.O. Adopts "W.W." Suggestion

Another important step in connection with the interference crusade is one which has just been taken by the Post Office. For some considerable time past forms to be filled in by listeners suffering from interference have been available on application to the Post Office Engineering Department. *The Wireless World* has felt that this method of reporting was unnecessarily troublesome to the listener, and we therefore brought to the notice of the Post Office the desirability of having these forms more readily available.

In our issue of June 30th, 1933, we urged that "the Post Office should simplify matters by arranging for the distribution and collection of these forms by all head Post Offices." Now, interference forms are being made available so that any listener troubled with interference can obtain a form from his local Post Office, fill it in, and post it, the form being already addressed to the proper department. We hope that all listeners experiencing interference will make use of this form, for by so doing they will greatly facilitate the task of the Post Office in locating and suppressing interference.

Television Explained

I. The Principles of Scanning

TELEVISION is fast approaching the stage when it can take its place in broadcasting as a companion to the familiar sound transmissions. It has not yet reached this stage, but the indications are that it will have become of entertainment value sooner than many realise. The present article is, therefore, the first of a series intended to give an introduction to the theory and practice of television, and to illustrate some of the problems involved.

THE transmission and reception of moving pictures, which constitutes television, is a matter fraught with many theoretical and practical difficulties, and the art is hardly more advanced than that of wireless telephony in the pre-broadcasting era. This does not mean, however, that television is in any way impossible, and, indeed, it is at the present time possible to obtain extraordinarily good results in the laboratory. The apparatus employed, however, is too expensive and complicated for general use. The point of importance is neither the expense nor the complication of the equipment but the fact that good results are possible, for there is no doubt that development will in time result in a cheapening and a simplification of the apparatus, and high-quality television will then become a commercial possibility.

It may be said, therefore, that at long last television is becoming feasible and worth while for the amateur, and is opening out an entirely new field for the experimenter. The present tendencies in television lie in the employment of ultra-short

wavelengths for transmission and the use of cathode ray tubes, at least for reception. Before the benefits conferred by these can be fully appreciated, however, it is necessary to have a full understanding of the older systems upon which the latest



(a) In making this picture a block with a normal screen has been used.



(b) In this picture a coarse screen has been employed with the result that much of the detail has been lost.



(c) Here the screen is so coarse that little resemblance to the original picture can be seen at first, but if examined from some distance the definition apparently improves.

developments are based. Let us therefore examine the requirements.

It is well known that in the cinema the picture thrown on the screen is not actually moving, but consists really of a series of still pictures, all very slightly different from one another, and succeeding one another so rapidly that the eye is deceived, and cannot distinguish them separately. Owing to the retentivity of the eye the impression produced by one picture persists for a fraction of a second, and before it has died away the next picture comes along.

It has been found that if not less than about ten pictures a second are thrown on the screen the impression of a moving picture is produced. With such a low picture frequency, however, there is a considerable amount of flicker, and it is now the standard practice in cinemas to

use about twenty-four pictures a second.

Now, in television, the same requirement holds good, and it is necessary to transmit from ten to twenty-four pictures a second. The requirements, however, are made more difficult by the fact that it is impossible to transmit even one picture instantaneously, as in the cinema. Only a minute portion of the picture can be transmitted at a time, and it is necessary to break up the picture into a large number of small pieces, transmit these one after another, and then reassemble them at the receiver. When it is remembered that the whole of this process must be carried out in from one-tenth to one-twenty-fourth of a second, some idea of the speeds involved can be gained.

The Photo-Cell

The variations in light intensity in the picture are converted into variations of an electrical current with the aid of a photo-cell. Such a cell is analogous to a valve in that the light falling upon it varies a steady current through the cell in the same way that a change of grid voltage in a valve varies the steady anode current. Provided that the cell is correctly operated the change in output current is proportional to the change in light intensity, so that we have available a distortionless method of converting variations of light into variations of current which are electrically equivalent to an alternating current superimposed upon a direct current, just as in the output of any ordinary valve.

It will be obvious that if we focused the whole picture to be transmitted upon the photo-cell the current through the cell would change by an amount depending upon the total illumination

Television Explained—

of the picture, and would not depend at all upon the details of the picture. If we break the picture up into quarters, however, and let the light from each quarter fall upon the cell successively, we shall obtain a different value of photo-cell current for each quarter depending upon the total illumination of each quarter. We shall still be far from perfect, and shall obtain no intelligible picture, but the results will represent an advance on those obtained by focusing the whole picture upon the cell. Following the same argument, it will be seen that if we break the picture up into an infinite number of elements and let the light from each fall successively upon the cell, we shall obtain electrical variations of current which constitute a complete copy in the different medium of every detail of the picture.

A Method of Scanning

All printed pictures are made in a similar way from an extremely large number of elements, and if any half-tone illustration be examined under a magnifying glass it will be seen to consist of a large number of minute dots, and the greater the number of dots to the inch the better the picture. This is well brought out by the illustration, which shows the same picture printed with different numbers of dots to the inch, or different screens. At (a) a normal screen of about 85 dots per inch is used, whereas at (b) a much coarser screen has been employed. The picture shown at (c) is still coarser, and it is instructive to note how much detail has been lost. If the pictures be regarded from a distance, however, the differences appear far less, and the worst picture becomes intelligible.

The dot analogy is not strictly accurate in television, for the picture is normally broken up into a series of lines rather than distinct dots. The underlying principle,

however, is the same, and the differences are brought about chiefly by the methods involved. The process of breaking the picture up at the transmitter and reconstituting it at the receiver is called scanning, and in its simplest form this is carried out by means of a Nipkow disc.

upon the photo-cell. This process is illustrated in Fig. 3, in which the original picture is seen at (a); (b) shows the scanning strips into which it is divided, and (c) shows the sequence of these strips from the point of view of time. At (d) will be seen the corresponding electrical current in the photo-cell circuit, the variations of current during the interval (A) corresponding to the variations in light intensity along the strip (A) and so on.

It will be obvious that the narrower the width of the scanning strips the greater will be the picture detail, for, assuming a square hole in the disc, the smaller will be the average illumination at any given instant. In other words, the greater will be the number of elements, or, in terms of half-tone illustrations, the finer will be the screen. In the present B.B.C. transmissions by the Baird process 30 lines are used and 12½ pictures are transmitted a second. There are thus 375 lines transmitted a second.

It will be readily apparent that the breaking of the picture into such a small number of lines must lead to a poor quality image at the receiver, but before considering the number of lines which is necessary for a good picture, it will be as well to examine the other details of the transmitter and receiver, and these will be dealt with in the next article.

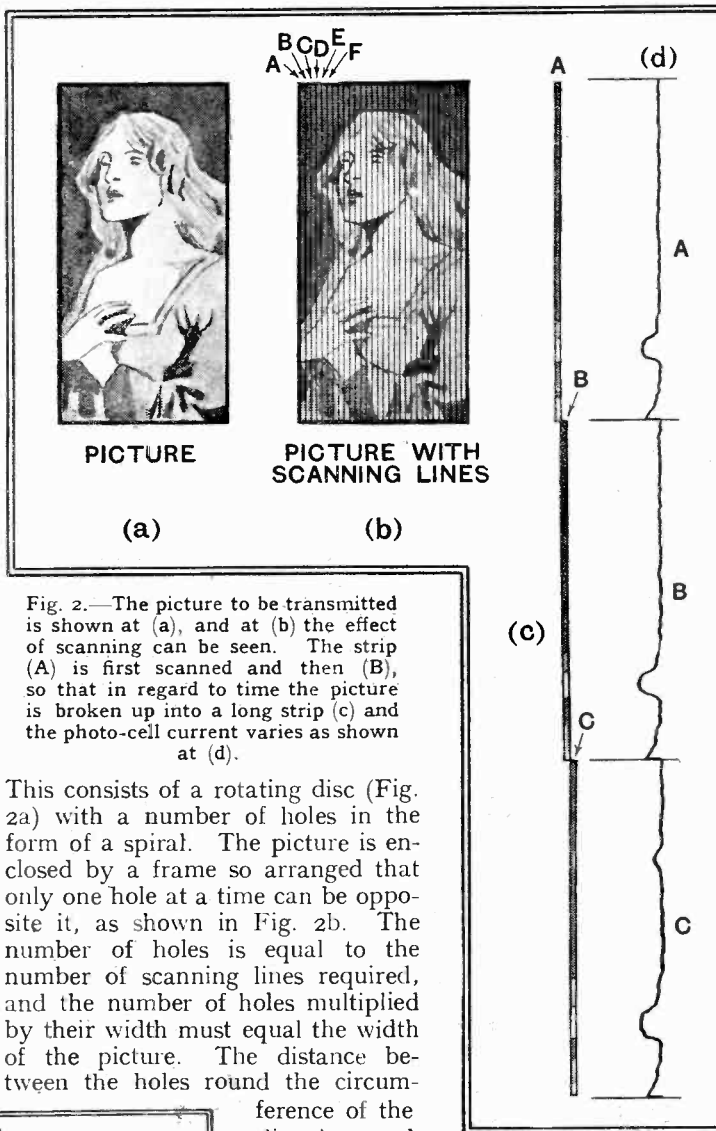

Fig. 2.—The picture to be transmitted is shown at (a), and at (b) the effect of scanning can be seen. The strip (A) is first scanned and then (B), so that in regard to time the picture is broken up into a long strip (c) and the photo-cell current varies as shown at (d).

This consists of a rotating disc (Fig. 2a) with a number of holes in the form of a spiral. The picture is enclosed by a frame so arranged that only one hole at a time can be opposite it, as shown in Fig. 2b. The number of holes is equal to the number of scanning lines required, and the number of holes multiplied by their width must equal the width of the picture. The distance between the holes round the circumference of the disc is equal to the height of the picture.

It will be seen, therefore, from Fig. 2b, that at the instant that hole (B) finishes its traverse of the picture, assuming the disc to be rotating in a clockwise direction, the hole (A) is just coming on to the picture, and will traverse a path immediately adjacent to it.

A set-up which could be used for transmitting a cinema film is shown in Fig. 2c, where the light from a lamp is directed through the film, and after being scanned by the disc falls

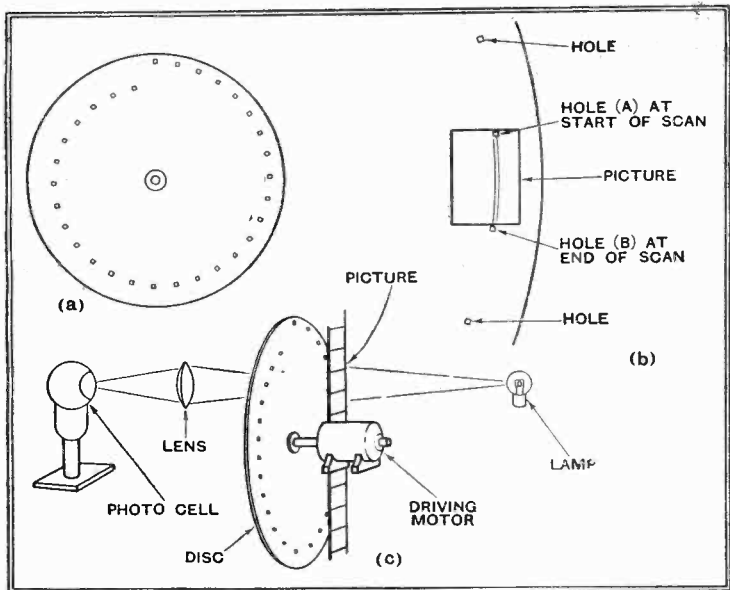

Fig. 1.—The scanning mechanism employed in simple television apparatus is shown diagrammatically. At (a) the arrangement of holes in the Nipkow disc can be seen, and (b) shows how the picture is traced by the successive holes. The complete arrangement for transmitting a picture from a cinema film is illustrated at (c).

NEXT WEEK'S ISSUE:

Valve Data Booklet

A Special Supplement giving full practical data on all types of valves. Invaluable to every serious reader.

The issue will also contain special articles on valves and their applications.

Practical HINTS and TIPS

AMONG those engaged in the heavier branches of electrical engineering, we wireless people have the reputation of being almost criminally negligent in the matter of providing safety fuses for our apparatus. Many of the criticisms which

Fuses for Mains Filters

have been directed against us are not altogether deserved, but in one respect at least we should take care to put our house in order. This is with regard to the fusing of by-pass condensers used in connection with anti-interference mains filters.

As most readers are aware, the purpose of these filters is to deflect H.F. currents superimposed on the mains supply from the household wiring, whence this energy is likely to be radiated (as from an aerial) and to interfere with broadcast reception. The subject has been dealt with exhaustively from time to time in these pages, and the difficulty of using choke-capacity filters has been explained. It might be added to what has already been said that, according to the Post Office engineers, most types of interference are mitigated by plain by-pass condensers, which, provided they can withstand the applied voltage, may be fitted without introducing complications.

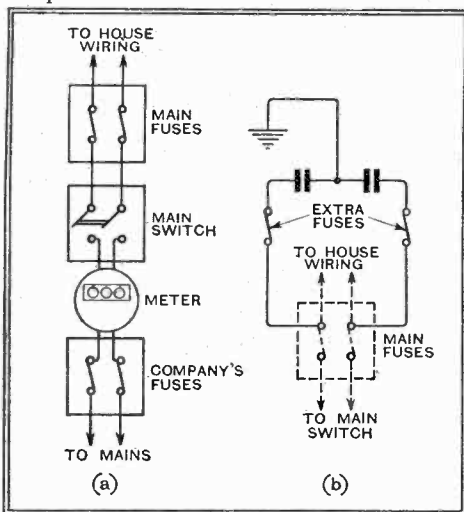

Fig. 1.—Usual method of installing a mains supply, and the safest position for an anti-interference filter.

In order that any type of mains filter may be thoroughly effective, it is essential that it should be connected as near as possible to the point of entry of the mains into the house. Those who are proposing to fit, or to instruct their electricians to fit, a filter will find it worth while to study the skeleton diagram given in Fig. 1. (a), which represents the ordinary sequence of connecting the various accessories employed in a domestic electrical installation. The mains are led directly to the company's fuse box, which is sealed and inaccessible; next comes the meter, and then

AIDS TO BETTER RECEPTION

the mains switch. For obvious reasons, no connection should be made to these points; anything that is added should be joined on the output side of the main fuses, which are connected to the on-off switch.

A little consideration will show that the result of a breakdown in a by-pass condenser connected either across the mains or between the "live" main and earth will be a direct short-circuit, which will blow the main fuses and put the whole house in darkness. Extra fuses of a much lighter gauge (capable of carrying, say, 1 amp.) should therefore be connected in series with the condensers, as in Fig. 1 (b), which represents the normal method of installing a plain capacity filter, and shows what is normally the correct point of attachment to the household wiring. Safety fuses are already fitted in this way in the Belling-Lee interference suppressor, which also comprises the necessary condensers, ready mounted, with terminals, in a moulded case.

IN designing an A.V.C. superheterodyne, it is quite usual to control the first detector as well as the signal-frequency H.F. stage and the I.F. amplifier. Anode-bend detection is almost universally employed for the first detector, and so it is practicable to decrease the sensitivity of the valve by applying an excess negative bias to its grid in just the same way as when dealing with an amplifying valve.

It should be made quite clear that, with ordinary valves, this form of control is applicable only when a two-valve frequency changer is employed. With a combined detector-oscillator the application of a high negative controlling voltage to the grid will prevent the generation of oscillations unless a Heptode is used.

The Pentagrid Oscillator

MOST people have found by experiment that, when a valve fails to oscillate freely as a result of tightening reaction coupling, self-oscillation can generally be brought about by increasing the applied anode voltage. The Pentagrid or Heptode valve now coming into use as a combined detector-oscillator in superheterodynes, is no exception to this rule, in spite of the fact that it is a multiple-electrode valve, in which one of the grids acts, so far as its oscillator function is concerned, as an anode.

At first sight it might appear easy enough to apply a higher anode voltage, but in a mains-operated set it is seldom possible to do this directly. Similarly, it is not generally realised that the fairly obvious alternative of increasing the working anode voltage by reducing the value of feed resistance is likely to prove abortive.

The reason for this is shown diagrammatically in Fig. 2, which represents in

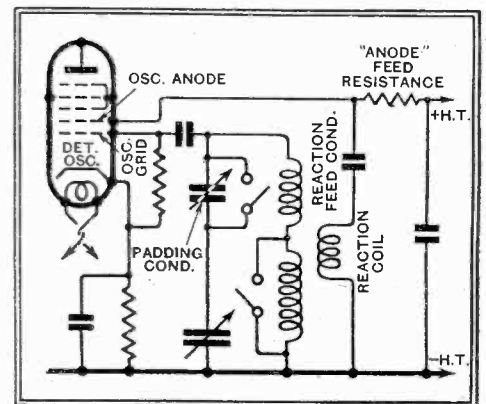

Fig. 2.—Showing that the feed resistance for the oscillator section of a Pentagrid valve is, in effect, in shunt with the reaction coil.

skeleton form the oscillator circuit of a superheterodyne using one of the new valves. The feed resistance through which voltage is applied to the oscillator "anode" is virtually in shunt with the reaction coil; any great reduction in the value of this resistance will impose a partial short-circuit across the reaction coil, and so, although the anode will be operating at a higher potential, it will generally be found no easier to obtain self-oscillation.

THEORETICALLY, the undistorted output obtainable from a pair of output valves connected in parallel should be just double that of a single valve of the same type. But in practice so great an increase is not always realised. Take the case of a D.C. receiver, where, due to a limited H.T. supply, the practice of fitting parallel valves is fairly

Parallel Output Valves

common. The addition of a second valve may reduce the working anode voltage to a serious extent, due to the greater loss of voltage in the smoothing equipment and output transformer primary.

This is where the "D.C. Superhet" scores. In this receiver (recently described in *The Wireless World*) the total anode current consumption is unusually low for such an ambitious set, and moreover, the circuit arrangement is such that a very limited amount of smoothing is required. Consequently there is very little loss of H.T. voltage, and so exceptionally great volume is obtainable from a single output valve.

Design for a Scratch Filter

Constructional Details and Hints on Adjustment

IMPROVEMENTS in the manufacture of gramophone records in recent years have gone far to minimise the irritation of surface noise, and where trouble is experienced on this score it is safe to assume that a fairly considerable high-note resonance is present in the electrical pick-up.

Surface noise covers a wide band of frequencies and is thus able to stimulate the natural resonance of the pick-up at whatever frequency it may occur. It is, in fact, quite easy with a little experience to estimate the approximate frequency of the needle armature resonance from the character of the surface noise. It is for this reason that in modern pick-up designs every effort is made to reduce as far as possible the rise in output due to armature resonance, and in the majority of cases this rarely exceeds 5 db. A year or two ago it was by no means uncommon to find units with otherwise excellent characteristics producing armature resonance amounting to 10 or 15 db., and where one of these units is still in use the introduction of a scratch filter will result in a very marked reduction of background noise without appreciably affecting quality in the upper register.

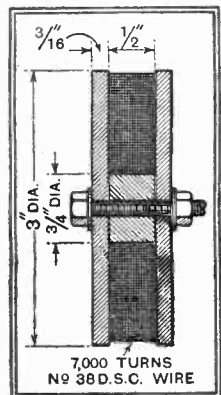

Fig. 2.—Essential dimensions of filter choke giving 1.8 henrys for a D.C. resistance of 1,000 ohms.

The characteristic of such a circuit is shown in Fig. 1, from which it will be seen that the impedance of the circuit reaches its lowest value at resonance. At this point the impedance is actually

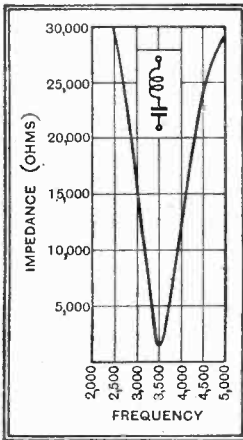

Fig. 1.—Impedance of acceptor circuit near resonance. Inductance 1.8 H., capacity 0.00117 mfd., D.C. resistance 1,050 ohms.

very little higher than the D.C. resistance of the coil, but at other points in the frequency range its impedance may easily rise to a hundred or more times this value.

In the majority of pick-ups the armature resonance lies between 2,500 and 5,000, and a suitable choke for this range is shown in cross-section in Fig. 2. The former consists of two 3in. discs cut from three-ply wood and spaced 1/2 in. apart by a 3/4 in. diameter centre boss. With 7,000 turns of No. 38 D.S.C. an inductance of 1.8 henrys is obtained for a D.C. resistance of 1,000 ohms. The tuning capacity consists of an 0.0005 mfd. variable in conjunction with two fixed mica condensers of 0.0005 and 0.001

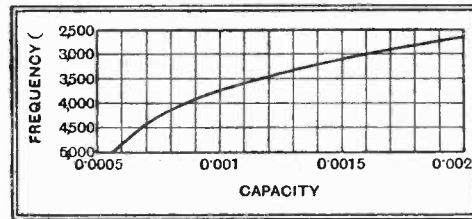

Fig. 3.—Tuning curve of acceptor circuit with an inductance of 1.8 H.

mfd. respectively. With this combination a continuously variable capacity from below 0.0005 to 0.002 is obtained, and in conjunction with the inductance already described gives the frequency range shown in Fig. 3.

The next step concerns the method of utilising the fall in impedance of the acceptor circuit to cancel the resonance peak in the output from the pick-up. Probably the best arrangement is that in which the acceptor forms the lower half of a potential divider connected across the pick-up terminals. In the circuit in Fig. 4 one half of the potential divider

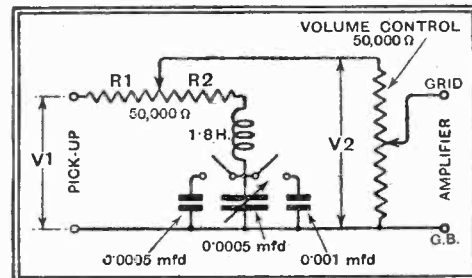
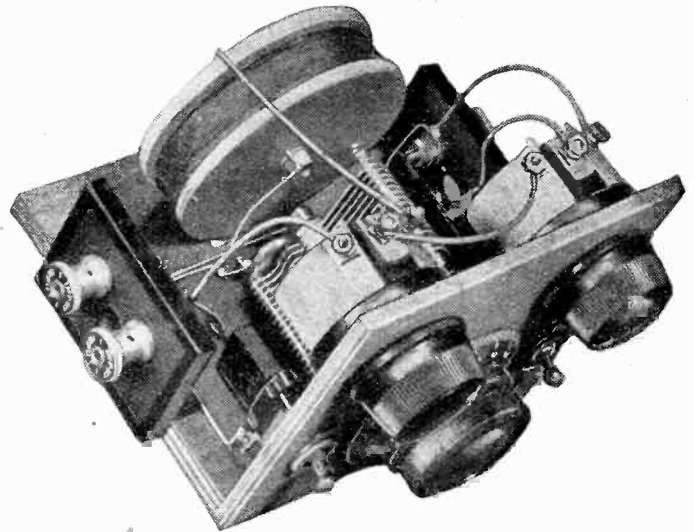

Fig. 4.—Complete circuit diagram of filter unit.



An experimental filter unit constructed on the lines advocated in this article

consists of R1, and the other of R2 in series with the tuned circuit. In order to obtain the required degree of correction at resonance it is necessary to adjust the slider so that the ratio of the impedance of the acceptor circuit in conjunction with R2, to the resistance of R1 (and, to a certain extent, the impedance of the pick-up itself) gives the required reduction in the ratio of V2 to V1. At frequencies other than resonance the volts passed on to the amplifier will be determined by the resistance of the volume control in relation to R1 and the pick-up impedance, since the impedance of the acceptor circuit will rise considerably above 50,000 ohms. In order to increase the correction the slider is moved to increase R1 and decrease R2, but this will also have the effect of reducing the general level of the output. This is unavoidable, but fortunately the reduction of the resonance peak progresses at a greater rate than the reduction in general level, and a satisfactory correction can be made in most cases without serious loss of volume. This point is brought out in the curves of Fig 5, which are actual measurements of the output of a commercial pick-up in the region above 1,000 cycles. The ratios of R1 to R2 were as follows: In Curve I, 1 to 3; Curve II, 1 to 1; Curve III, 3 to 1. It will be seen that the latter ratio gives a slight over-correction of the peak, so that

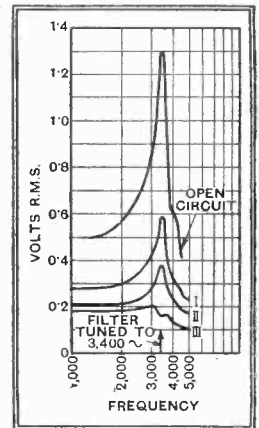

Fig. 5.—Pick-up characteristic in region of armature resonance, with and without filter. Curve III shows the effect of over-correction.

of Fig 5, which are actual measurements of the output of a commercial pick-up in the region above 1,000 cycles. The ratios of R1 to R2 were as follows: In Curve I, 1 to 3; Curve II, 1 to 1; Curve III, 3 to 1. It will be seen that the latter ratio gives a slight over-correction of the peak, so that

Design for a Scratch Filter—

the correct adjustment would have been given by a slightly higher value of R2.

The preliminary adjustments of the filter should be made with R1 at maximum and R2 at zero. This gives the highest possible degree of correction and enables sharper definition to be obtained when tuning out the scratch. Having found the pick-up resonance, the next step is to increase R2 and reduce R1 as far as possible

without reintroducing the surface noise. This will avoid an unnecessary reduction in high frequency response.

In conclusion, it should be realised that the scratch filter of necessity causes a reduction of the average output, and that in some cases an extra stage of amplification may be called for. In general, the less the degree of correction required by the pick-up, the smaller will be the reduction in general volume.

DISTANT RECEPTION NOTES

Spanish Mystery : Stations that Lose Power

A NEW Spanish station was opened recently at Tarragona. This is EAJ33, which is working on a wavelength of 202 metres. I have not so far picked up its transmissions, but since on certain nights stations near the bottom of the medium waveband are wont to come through with almost uncanny strength I have no doubt that it will be received before long. Several of the Spanish stations used at one time to be amongst the best received of Continentals in this country. Old hands will remember Radio Iberica, which seven or eight years ago operated with an output power of not more than two kilowatts, but was heard night after night at enormous volume on the small "straight" sets that most of us used in those far-off days.

Then Madrid Union Radio had its day. It used to be received quite as powerfully as is Toulouse nowadays. The next Spanish station to come into prominence was Barcelona EAJ13, which was so easy to find that the veriest beginner could tune it in without difficulty, despite the many control knobs that receiving sets sported at that time.

Now, even with a super-heterodyne, it is difficult to receive any of the Spanish stations at all well. I have often wondered why it is that so many stations are magnificently received when they first come into operation, and for perhaps a year or more afterwards. Then a decline sets in, and the time comes eventually when the volume obtainable from them dwindles to a mere fraction of what it originally was.

Shrinking Volume

Motala is a case in point. When it began operations this station was as strong by day or by night as 5XX, though the latter is only forty-five miles distant. Now, though generally receivable at loud speaker strength, it is a mere shadow of its former self.

The old Vienna Rosenhügel station had a similar history; Lwow has behaved in much the same way, and other instances are to be found in Paris Ecole Supérieure, Berlin Witzleben, Lille PTT, Copenhagen, Hörby, and the old 8-kilowatt Kalundborg transmitter.

Though it was announced recently that the 60-kilowatt Munich station was closing down to enable work to go forward on the new aerial mast for the 100-kilowatt transmitter which will come into operation on January 15th, I can record quite good reception of this German station up to the evening before these notes were written. If it was the old 1.5 kilowatt plant that was responsible for the transmissions in question it is giving a very good account of itself. Munich should be a magnificent transmis-

sion after January 15th, though the new wavelength of 405.4 metres will not then be quite so favourable for long-range reception.

Reception on the long waves has not been too good of late. The reason is not that the field strength of stations is not adequate; it is that interference has been so rampant. Huizen still suffers from the attentions of Brasov, and, apparently, of a Russian station as well; Luxembourg has been badly heterodyned—apparently by Reykjavik—and Kalundborg is once more spoilt by Monte Ceneri. The long-wave stations most worthy of attention are Radio-Paris, Zeesen, and Motala.

There is also a great deal of interference

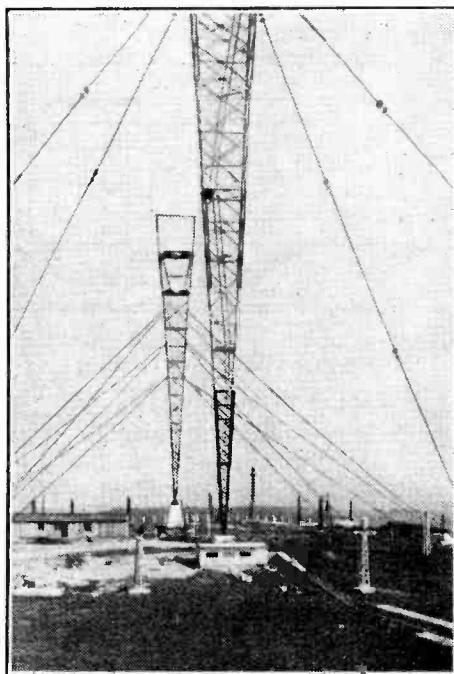

"NOT GOOD ENOUGH" has been the verdict of listeners to the new Vienna station at Bisamberg. A second mast is now being erected, as shown in this "snap," taken last week by a *Wireless World* correspondent.

on the medium waveband. Hilversum has occasionally been interfered with by a heterodyne which appears to be due to a harmonic of Luxembourg. Beromünster and Bari have also been sufferers from heterodynes.

Nevertheless, there are plenty of stations to be found quite clear of interference. The best at the present time are Budapest, Prague, Langenberg, Rome, Stockholm, Toulouse, Midi, Leipzig, Strasbourg, Brussels No. 2, Poste Parisien, Breslau, Göteborg, Heilsberg, Frankfurt, Trieste, and Nürnberg.

D. EXER.

CLUB NEWS

New Session

From all quarters we learn of the resumption of club meetings, and indications are that the 1933-34 session will be as busy and profitable as any in the history of the amateur radio movement.

One reason for this promising state of affairs is the ease with which the average wireless club can be organised and run to-day. Although it is not true to say that a club will run itself, every club secretary can now profit by the experience of other clubs throughout the last ten years, as reflected in the club reports published in *The Wireless World*.

Newcastle

The Newcastle-upon-Tyne Radio Society has arranged an attractive programme of lectures, demonstrations and visits to works during the coming session. All communications should be addressed to the Hon. Secretary, Mr. William W. Pope, 9, Kimberley Gardens, Jesmond, Newcastle.

Birmingham

Members of the Slade Radio (Birmingham) Society enjoyed a lecture on the "Cathode Ray Oscillograph and its Application to Radio Circuits," given by Mr. G. Parr, of the Edison Swan Electric Co., Ltd., recently. Various wave forms were demonstrated and could be seen quite clearly.

Hon. Secretary, 110, Hillaries Road, Gravelly Hill, Birmingham.

London, W.

The Radio, Physical and Television Society, thanks to the facilities accorded by Dr. C. G. Lemon, now has the use of 42- and 5-metre transmitters, together with various types of electrical apparatus, X-rays, etc. Television demonstrations are to be given by the President, Major Oates. The headquarters are at 72a, North End Road, West Kensington, London, W.14, and full particulars regarding the Society can be obtained from the Hon. Secretary, Mr. F. J. Bubear, 67, Nassau Road, Barnes, S.W.13.

Exeter

West of England amateurs are well catered for by the programme of the Exeter and District Wireless Society during the coming months, which will include lectures on short-wave work, modern radio practice, choosing a loud speaker, besides visits to places of interest.

Full particulars are obtainable from the Programme Secretary, Mr. E. H. Ware, "The Beeches," Woodbury, Exeter.

Croydon

The Croydon Radio Society can now accommodate fifty people at its meetings at the new headquarters, St. Peter's Hall, Ledbury Road, South Croydon. Full particulars regarding the new session can be obtained from the Hon. Secretary, Mr. E. L. Cumbers, 14, Campden Road, South Croydon.

Kettering

The Kettering Radio and Physical Society recently held a successful radio exhibition at which nearly 10,000 people paid for admission, the contingents coming from as far afield as Wellingborough and Bedford.

Full particulars of the coming session can be obtained from the Hon. Secretary, Mr. R. J. Pankhurst (G5YF), 9, Shakespeare Road, Kettering.

North Middlesex

The new Hon. Secretary of the North Middlesex Radio Society is Mr. J. G. Turner, 3, The Ridgeway, Old Southgate, N.14., to whom all enquiries should be addressed.

Cambridge University

The new Hon. Secretary of the Cambridge University Wireless Society is Mr. J. Forster Cooper (Gonville and Caius College, Cambridge).

By Air to the Antipodes

Radio Survey that Broke Records

By W. J. E. BROWN,
Marconi Operator

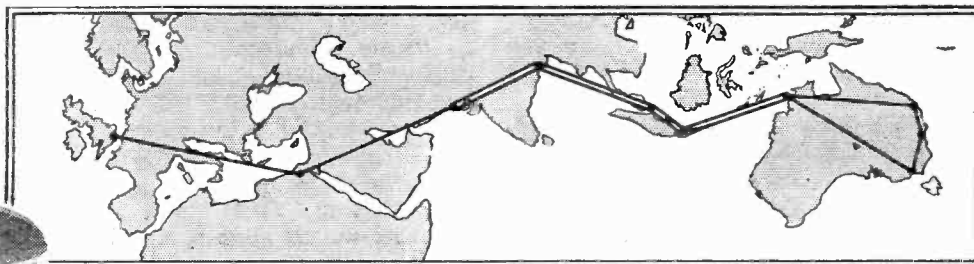

The flight covered half the world. On the left is an "Atalanta" class 'plane of the type used on the survey.

FOR the survey of the proposed England-Australia air route recently completed by Major H. G. Brackley, D.S.O., D.S.C., Air Superintendent of Imperial Airways, Limited, the choice of one of the "Atalanta" class aeroplanes—"Astraea" (G-ABTL)—was particularly appropriate from the wireless standpoint, because all the new fleet of eight "Atalantas" operated by Imperial Airways, Limited, are equipped with the latest type of Marconi aircraft equipment.

"Astraea" flew from the Air Port of London, Croydon, to Melbourne, Australia, and back to India, a distance of more than 23,000 miles, and, in Major Brackley's own words, "everything went like clockwork."

In addition to enabling us to defeat the heavy atmospherics encountered in the monsoon areas our combined medium and short-wave equipment achieved some interesting long-range ground-and-air communications (two-way), although our object was not to concentrate on distant communication, but rather to keep in constant touch with the ground through a series of stations in each territory covered by the flight.

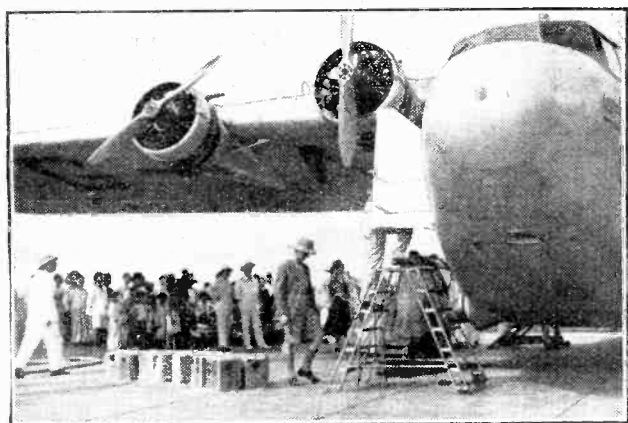

The "Astraea" photographed while refuelling at Batavia on the homeward journey.

The wireless transmitter and receiver installed in "Astraea," as in all the "Atalanta" class aircraft, for Imperial Airways, Limited, is known as the Marconi Type A.D.37A/38A equipment.

The waveranges adopted as a result of extensive practical tests carried out over the African air route are 40-80 metres and 500-1,000 metres.

The transmitter is provided with the independent drive method of frequency control, the valves used comprising two magnifier valves connected in parallel, one independent drive and one modulator.

The receiver employs one screen grid high-frequency amplifier, one detector with adjustable reaction coupling, and one low-frequency magnifier.

Power for the anode and filament circuits of both transmitter and receiver valves, and also for aircraft lighting purposes, is derived from a generator fitted with a constant speed windmill and developing 200 milli-amperes at 1,200 volts, and 15 amperes at 16 volts, for the high- and low-tension supplies respectively.

The Marconi-equipped "Atalanta" aircraft are also fitted with a wireless navigational aid in the form of the Marconi-Robinson directional receiving equipment.

The Marconi-Robinson system of direction finding provides what is essentially a "homing" device to enable the pilot to set his course on a known ground station. While the aircraft is on its correct course no signal will be heard from the direction finder when it is brought into operation with a special three-way switch in its central position. The alteration of the course will cause signals to be received, and by turning the switch

first to one side and then to the other and listening to the relative strengths of the signal an indication is immediately obtained as to whether the aircraft is to starboard or port of its true course. The

correction in course can then be made until the strength of signals is unchanged, whether the switch be to the left or right, and the accuracy of the course so determined can be checked by putting the switch to the central position when, if the course is correct, no signal will be heard.

The first section of the flight, from Croydon to Karachi, followed the normal air route. The usual good service was obtained from Croydon, Le Bourget, Dijon, and Lyons, on 900 metres, the international aircraft waveband, and, on leaving Lyons, information regarding the weather and upper winds off Genoa and Pisa were obtained direct from Genoa.

After passing Antibes good two-way communication, both speech and telegraphy, was established with Croydon on 45.5 metres, and it seemed but a little later that, between Brindisi and Athens, Cairo was worked on the same wavelength.

Regular communication with the ground was maintained throughout the Cairo-Karachi section of the flight, working on both medium and short waves with the stations at Cairo, Gaza, Rutbah Wells, Baghdad, Sharjah and Gwadir.

New Use for "Homing" Device

After leaving Karachi we had departed from the regular Imperial Airways routes, and between that station and Calcutta a good deal of direction-finding work and weather information was required. Calcutta also has a Marconi-Adcock direction-finding station, and several very good bearings were obtained from this station and checked with our own "homing" equipment.

There was an incident of exceptional interest between Akyab and Rangoon, when communication was established with a homeward-bound Dutch machine belonging to the K.L.M. organisation. The Dutchman's course was checked with our "homing" device and was found to

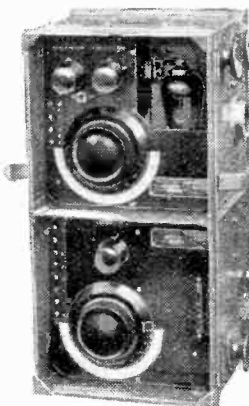

The amplifier and three-way switch of the Marconi "homing" equipment.

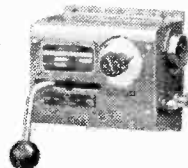

By Air to the Antipodes—

be approximately the same as our own. I therefore asked at what height he was flying, and we altered our own height accordingly. It seems that this might be a very useful application of the "homing" device when flying in bad visibility and in the vicinity of other aircraft.

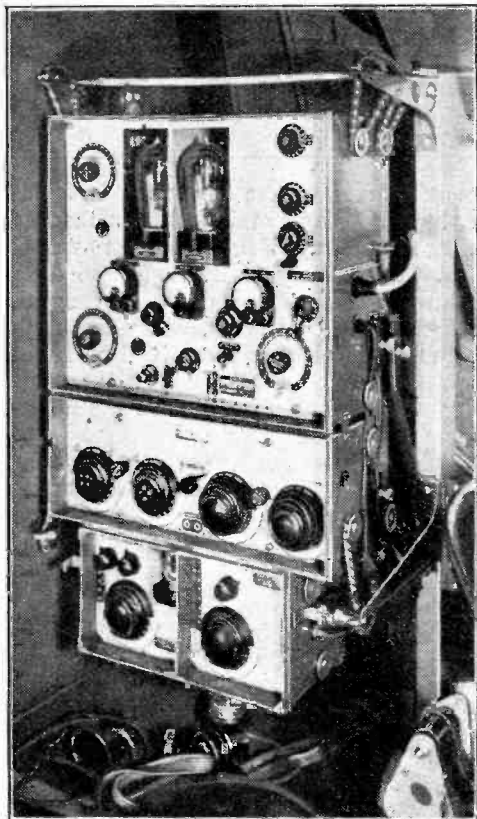

The "Astraea's" Type A.D.37a/38a Marconi equipment. On top is the transmitter and below it the receiver. The smaller instrument box contains the "homing" device.

The first communication with Darwin (North Australia) was made just after leaving Sourabaya (Java), G-ABTL transmitting on 45.5 metres and Darwin answering on 40 metres.

Crossing the Timor Sea (between Java and Australia) short-wave schedules had to be abandoned, as I was kept busy on 600-metre working with ships; we also had good service from Darwin on this waveband, from whom particulars of the landing-ground on Bathurst Island were received. After landing on Bathurst Island an hourly watch was kept with Darwin on 600 metres, there being no regular channel of communication between the island and the mainland, and a large number of messages was sent and received.

On the Return Flight

The final "hop" between Sydney and Melbourne covers an area well known for poor reception, due to the mineral properties and screening of the Blue Mountains. No undue difficulty was, however, experienced by "Astraea," and although the maximum range with Sydney on 600 metres was only about 200 miles, Adelaide came in very well on the same wavelength. The flight back across Australia was un-

eventful, Darwin and Sydney being held practically all the way until arriving at Darwin. For the Timor Sea crossing we "homed" on Koepang (600 metres). Leaving Koepang, Batavia "PMH" was heard sending high-speed traffic on about 44 metres. Suddenly, "PMH" began calling "G-ABTL," and we had excellent communication.

Singapore "GEO" was worked on short waves soon after leaving Sourabaya.

On the flight from Singapore we kept in touch with "GEO" and also Penang on short waves, atmospherics being very bad on long waves.

Atmospherics were extremely bad from Calcutta to Karachi, and the value of short-wave working in these circumstances was exemplified by good reception of a number of short-wave stations, including Berlin and Moscow.

Within a short time we were again at Karachi, and back on the regular air route, feeling that we were indeed Empire pioneers.

BOOKS RECEIVED

The Yorkshire Radio Book, by Leslie W. A. Baily, including the history of Broadcasting in the North from 1923 to 1933. Interesting notes concerning Northern stations, studios, and programmes of the personnel connected with them, a list of Yorkshire amateur transmitters and sundry useful data. Pp. 84, with numerous illustrations. Published by the Yorkshire Conservative Newspaper Co., Ltd., Change Court, Albion Street, Leeds. Price 6d.

Hints and Kinks for the Radio Amateur.—Compiled by the American Radio Relay League, Inc., West Hartford, Conn., and comprising many useful hints for use in the

FOREIGN BROADCAST GUIDE

BRESLAU

(Germany).

Geographical position: 51° 5' N.; 17° E.
 Approximate air line from London: 745 miles.
Wavelength: 325 m. Frequency: 923 kc/s.
Power: 60 kW.
 Standard time: Central European (one hour ahead of G.M.T.).

Standard Daily Transmissions

05.00 G.M.T., physical exercises from Berlin (except Sundays); 08.00 approx. (Sun.), sacred concert; 10.30, weather and news; 11.00, concert; 15.00-16.30, light concert (talk in interval); 19.00, news, followed by main evening programme; 21.15, time signal, weather and news; 21.30-23.00 (except Mondays), dance music.

Announcer: Man.
 Call: *Achtung! Hier Schlesischer Rundfunk Breslau und Gleiwitz.*
 Interval signal: Metronome (200 beats per minute) and/or opening bars of Hofeifriedberger March, as under:



Closes down with good-night greetings, followed by *Deutschland Ueber Alles* and/or the *Nazi Horst Wessel* marching song.

Relay: Gleiwitz, 253 metres (1,184 kc/s.) 5 kW.

workshop, constructing receivers and transmitters, microphones, remote control, interference elimination, power supply, aerials, earths, etc. Pp. 80, with numerous illustrations and diagrams. Copies can be obtained in Great Britain from Mr. F. T. Carter, Flat A, Gleneagle Mansions, Streatham, for 2s. 9d., post free.

Les Récepteurs Radiophoniques Modernes à la portée de tous, by Franck Duroquier, giving constructional details of various receivers ranging from a simple crystal set to a six-valve superhet and a five-valve all-range set, with chapters on the upkeep, adjustment, and testing of these receivers. Pp. 191 + viii, with 138 diagrams and illustrations. Published by Masson et Cie, Paris. Price 24 francs.

Electrical Interference

Questionnaire Now Available at Post Offices

If you suffer from electrical interference you will now be able to obtain an interference form from your local Post Office. "The Wireless World" recommended this simplification of the former procedure of having to apply, in writing, to the Engineering Department of the Post Office or through the intermediary of the B.B.C.

The wording of the form is as follows:—

If interference is experienced when stations of the British Broadcasting Corporation are being received and it has been ascertained that the receiving set is in no way faulty, this form should be completed and forwarded by post.

The interference will be investigated and particulars of the necessary suppression apparatus will be furnished without charge. The costs subsequently involved in the permanent installation of suppression apparatus cannot be borne by the Post Office.

1. Are you using a valve set or a crystal set? If valve, state number of H.F. and L.F.
2. Does your receiver draw any part of its H.T. or L.T. supply from the electric light mains?
3. Has your set or aerial, etc., been altered in any way prior to the commencement of the interference? (Please give particulars.)
4. (a) Are your neighbours simultaneously suffering the same interference as yourself?
 (b) Is the proportion of interference to music the same in neighbours' receivers as in your own?
 (c) To which British Broadcasting Station do you listen most frequently?
 (d) Is this Station affected by the interference?
 (e) Is the Daventry Long Wave Station (5XX) affected?
5. Do you know, and can you give the address of, any local listener who hears the interference at a greater strength (in proportion to the broadcast transmission) than yourself?
6. (a) Does the interference cease when you disconnect (1) your aerial, (2) your earth, or (3) both? (Please ensure that your set is not oscillating when the aerial or earth is removed.)
 (b) Have you examined your aerial and earth wires and connections for frayed strands or bad joints?
7. State periods when interference is most pronounced.
8. If you are not a new listener, has the interference suddenly commenced?
9. Can you give date when interference first noticed?

Post Office Research

A Tour Round the New Experimental Station

TO provide facilities for the investigation of technical problems, which yearly increase in number, considerable extensions have recently been made to the Post Office Research Station at Dollis Hill, London, N.W. The new buildings, which were officially opened last Monday by the Prime Minister, are not, of course, devoted exclusively to radio, but a great deal of extra space has been allotted to that important section.

There are no secrets at Dollis Hill. As members of a Department of State devoted to public service, the engineers in charge—as keen and well-informed a body of men as any in the country—were willing to discuss freely all the aspects of their work, and to describe everything that was going forward during our visit.

One envies the Post Office its new screened room for testing high-gain receivers and for other work where the introduction of disturbing potentials from extraneous sources is likely to lead to inaccuracies. This laboratory is completely lined with steel plates $\frac{1}{4}$ in. thick, all joints being welded together; air is admitted through “baffled” ducts, and even these can be closed up. The steel door has a double seal, and in order that the room may be isolated from the

fier for modulation, while it is interesting to note that the corresponding receiver operates on the super-regenerative principle, with a separate generator for the quenching frequency.

Another interesting short-wave receiver of the “double superheterodyne” type, with triple detection, is being built for the Portishead station, which communicates with shipping. Directional reception is carried out, and as soon as the bearing



“To strive, to seek, to find.”

of the communicating ship has been ascertained, a corresponding adjustment of the transmitting beam is made from the receiver panel.

In the acoustic laboratory, apparatus is installed for taking the frequency characteristics of loud speakers and microphones. There is also an “artificial ear” employed mainly for rapid testing of telephone receivers, which imposes the same acoustic load on the diaphragm as does the human ear.

All aspects of low-frequency amplification which affect the Post Office can be investigated. A particularly interesting constant-volume L.F. amplifier has lately been developed; this piece of

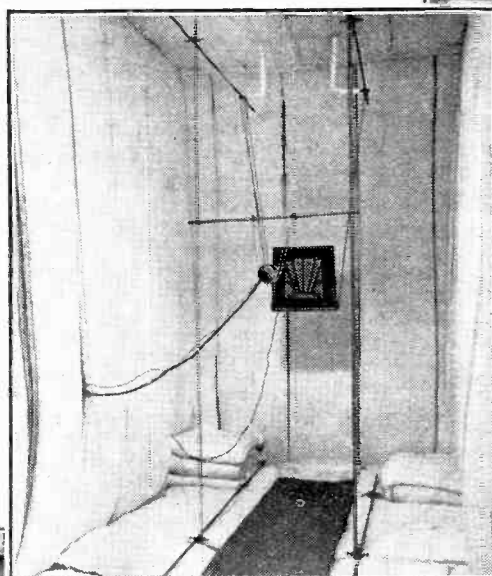

(Above). The non-reverberant chamber for loud speaker tests is padded to a thickness of 18 ins.

(Left). A super-regenerative receiver for ultra-short waves.

(Right). The “artificial ear” used in making graphical records of telephone characteristics.

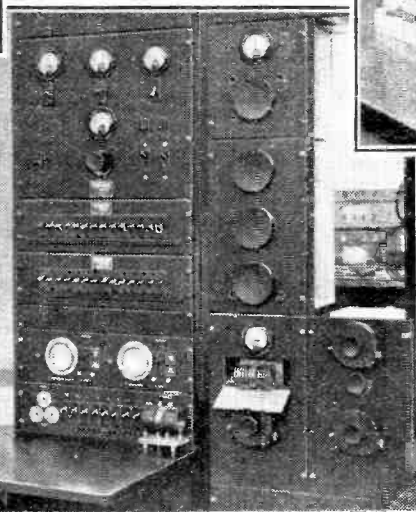
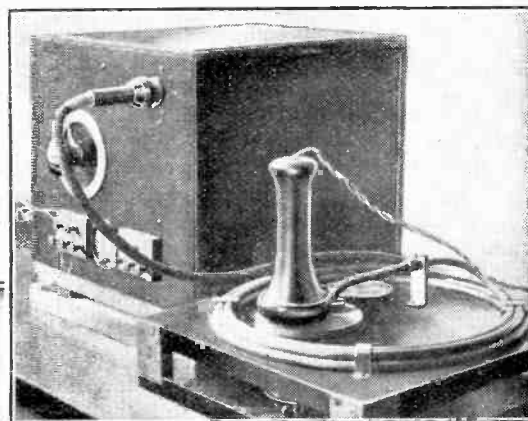
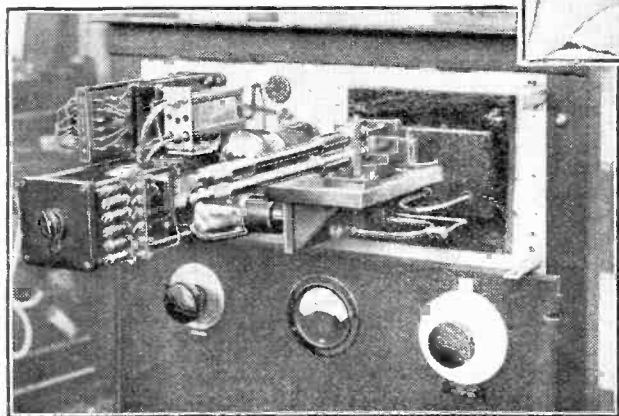

The latest “double-beat” short-wave superheterodyne for communication with ships.

mains a local lighting battery is installed.

Frequency measurements and standardisation, both at H.F. and L.F., are naturally of considerable importance. The main laboratory where this work is carried out derives its primary standard frequency from a valve-maintained 1,000-cycle tuning fork running at a constant temperature in a subterranean chamber; the accuracy is of the order of three parts in ten millions.

Short and ultra-short waves are occupying much of the attention of the staff. For the use of a radio link as a supplement to the land lines, new transmitters and receivers operating at between 4 and 6 metres are in course of development. The transmitter employs a Class “B” ampli-

apparatus embodies what may be described as A.V.C., as the output remains sensibly constant in spite of input variations up to 40 decibels.

The laboratory which works on the elimination of electrical interference with broadcast reception is well equipped with the appliances which cause this interference—motors, flashing signs, vacuum cleaners, etc.—in order that experiments can be conducted on strictly practical lines. The design of “stopper” coils for tramways is being studied intensively.

NEWS of the WEEK

Current Events in Brief Review



[Photo: "Q.S.T."]

MORSE QUEEN. Jean Hudson, the nine-year-old who has won the world's championship, Class "E," at Chicago, by transmitting code at 20 words per minute.

Radio Conscious

"**BROADCASTING DAY**" is to be celebrated in Germany towards the end of November.

A Radio Curfew

TENANCY agreements for new workmen's flats at Seedley Road, Salford, stipulate that wireless sets must be switched off at 11 p.m.

Budapest's Interval Signal

UNTIL the new Budapest transmitter is ready, the Hungarian Radio Company will not alter the present interval signal, which consists of a nine-note melody produced by a musical box.

Crystal Users in Austria

NEARLY 17 per cent. of Austrian listeners still use crystal sets. The total number of registered licence holders is about 48,000. The Austrian Government has declined to increase the amount of the licence fee by 25 per cent. at the request of the broadcasting organisation, "Ravag."

A Spanish Duel

A BITTER duel is in progress between Barcelona Radio, EAJ1, and Radio Association of Catalonia, EAJ15, over the question of recognition as the official transmitting station for the new Catalan Regional Government. According to a correspondent, the situation is complicated by the fact that the Lucerne Plan assigns to Barcelona, capital of the region, only one exclusive wavelength, namely, 274 metres. The only other available wavelength will be the common wave of 207 metres, already used by some fifteen small stations in Spain. The indications are that Radio Barcelona EAJ1 will win the battle for this exclusive wavelength and the honour of representing the Government.

Rumours Denied

SINCE the Amsterdam Conference there have been persistent rumours of the forthcoming dissolution of the Union Internationale de Radiodiffusion. We have been asked to state that such rumours are entirely without foundation.

Running Commentaries on Films

AN interesting novelty is featuring in the programmes at Radio-Toulouse in the shape of the broadcasting of sound films. The films are run through the projector in the ordinary manner so that listeners hear the speech and music as at the cinema; simultaneously an observer gives a running commentary on what he sees on the screen.

Broadcasting Insect Notes

HIGH notes which confound the best of loud speakers are the medium of conversation in the insect world—a thought which has prompted Professor Larsen, of Oslo, to devise a special microphone which will make insect noises audible to human ears. A correspondent suggests that the Professor might invent a direction finder to locate and destroy a certain exceedingly elusive species.

U.S. Broadcasting Dilemma

A DILEMMA faces the American Federal Radio Commission. The Government has now granted ten new channels between 1,500 and 1,600 kc./s to the Commission, and it is assumed that these are available for broadcasting purposes. Consequently the Commission has been bombarded with requests for these wavelengths from various stations in the U.S. The Commission feels, however, that the best policy, in order to avoid interference from stations

I.E.E. Wireless Section

AT a meeting of the Wireless Section of the Institution of Electrical Engineers at 6 p.m. on Wednesday next, November 1st, Mr. G. Shearing, O.B.E., B.Sc., will give an inaugural address as Chairman of the section.

"Music from the Air"

ON Thursday next, November 2nd, Mr. Martin Taubmann will demonstrate the "Electronde" at a meeting of the Golders Green and Hendon Radio and Scientific Society at the Hampstead Public Library. The meeting will open at 8.15 p.m., when Mr. H. J. Barton Chapple, Wh.Sch., B.Sc., will give an introductory address. Readers of *The Wireless World* will be welcomed.

German Post Office and Television

INTERESTING plans for television are discussed in an official statement of the German Post Office. At a conference held on October 16th, between the German Ministry of Posts and the Broadcasting and Television Authorities, it was stated that research is now to be concentrated on 180-line images with the retention of the present number of frames per second, namely, twenty-five. The existing high-power ultra short wave transmitter at Berlin is to be adapted to the new system and the work should be completed within two or three months. In the meantime the television industry will produce a number of suitable new television receivers.

The second ultra short-wave transmitter is to be used for the transmission of sound as well as vision, and this will be completed by April next, when the transmission of sound films will be tried.

The German Post Office ex-

Bouquet from U.S.A.

AN indirect compliment is sometimes more satisfying than the most outspoken praise. We have reserved a special place in our scrap-book for the following graceful tribute from a correspondent of our contemporary, *Radio News*, New York: "I wish to express my appreciation of *Radio News*, which I have now taken for six months. While I consider *The Wireless World* is the best weekly from the point of view of an English book, there is no monthly magazine on the market that in any way approaches *Radio News* for value."

New Musical Instruments

A MICROPHONE class has been opened at the Paris Ecole Superieure de Musique under the direction of M. Eric Sarnette.

An interesting by-product of recent tests at the School has been the invention of several new musical instruments which are stated to be specially suitable for the microphone.

It is surprising that inventors have not given more attention to the development of instruments favourable to modern electrical transmission. It has yet to be proved that the musical instruments now generally in use are the last word so far as broadcasting is concerned.

Wireless League Handbook

WHAT the Wireless League is and what it does is brightly set forth in the newly published handbook of the Wireless League, issued from the headquarters, 12, Grosvenor Crescent, London, S.W.1, price 6d. In addition to articles by the Hon. Sir Arthur Stanley and Captain Ian Fraser, M.P., the booklet includes some useful "don'ts" for the wireless user, hints on fault finding, and information on wireless law.

Interference to Order

SPECIALLY manufactured static is now applied to radio chassis on test at the Marconiphone factory at Hayes, Middlesex. For obvious reasons, the electric power mains at Hayes are steady and accurate, but it has been realised that a chassis which has been up to standard on works test might be very noisy on bad mains. So a certain section of the mains circuit, which has been isolated, is fed with interference of a particularly obnoxious kind from a 700-cycle oscillator with a heavy second harmonic. The engineers consider that this oscillator gives conditions equal to the worst kind of mains ever likely to be encountered.

"The Wireless World"

A.V.C. Three

IN the table of Voltages and Currents for this receiver which appeared in *The Wireless World* for October 20th, 1933, the output valve was given as type Pen 4VA instead of AC/Pen; the figures, of course, are correct for the latter valve.



MIDNIGHT OIL was burned to secure for H. L. O'Heffernan (G5BY) this medallion issued in the recent International Relay Competition to entrants who were first in their respective countries. G5BY obtained 10,860 points and topped the British list for the fifth consecutive time.



in Mexico and Canada, will be to make a free gift of this frequency band to one or other of these countries.

If this course should be followed, American stations may allege unfair treatment, and the Commission is faced with an unpleasant dilemma. If in this case charity begins at home, interference may make itself felt from abroad.

plains that it is anxious to develop television so that it may become an integral part of the broadcasting programmes as soon as possible. Germany, it is explained, must retain the "advantage which it has at present gained in television technique over developments in other countries."

BROADCAST BREVITIES

By Our Special Correspondent

"House of Mystery" Broadcast To-morrow

IF the first vaudeville programme from the St. George's Hall studio to-morrow night (Saturday) sounds thin and sepulchral, do not put this down to the natural "spookiness" of the place; the hollow sound will be due partly to the fact that on this occasion there will be no audience.

The engineers are now experimenting with the acoustics of the hall, and already the stage has been somewhat extended to bring the performers outside the proscenium arch.

Studio Audiences of 600

In the fullness of time select audiences will be admitted to St. George's Hall just as they now attend vaudeville performances at Broadcasting House and "No. 10," but there will, of course, be no question of payment as the B.B.C. is not taking out a licence as in the case of the Concert Hall at headquarters.

St. George's Hall will comfortably contain at least 600 persons, so at this rate the B.B.C. should soon cut down the length of that waiting list.

Now is the time to apply for admission.

A Secret

Meantime, it is said that the B.B.C. chiefs are gazing longingly at the Queen's Hall itself! But perhaps on this point I had better say no more at the moment.

Filming Broadcasting House

MR. JOHN GRIERSON, the film producer, has wisely (I think) decided to omit the love element in his film of Broadcasting House, the scenario of which is now nearly ready. So certain writers who have tried to liken the new film to "Grand Hotel" are, in some respects, off the track.

"Grand Hotel"

The only real point of resemblance will be in the scenes of that impressive entrance hall with its ceaseless flow of visitors. But there again, if I remember rightly, nearly all the callers at Grand Hotel secured admission, but as anyone who has waited in the vestibule at Broadcasting House knows, not a few visitors there are turned empty away. Which, from the listener's point of view, is a good thing.

In this connection I sometimes think that those who condemn the B.B.C. programmes might soften their tone if they knew how many turns are not broadcast.

The Power of Droitwich

AS exclusively stated in these columns in the issue of September 28th last, the new Droitwich transmitter, it is now officially announced, will employ a power far in excess of the nominal 100 kW. Actually 150 kW will be employed in the aerial, although, as I have already said, it will be possible to secure an output of 200 kW.

Scrapping the Nationals

It is common knowledge, of course, that the opening of Droitwich will see the end of the London, West and North National stations. Because West and London National are already sharing a wavelength, this will mean that the closure of the three

Nationals releases two wavelengths, one of which will be allotted to the new North Eastern station at Newcastle and the other to the North Scottish at Culloden.

The scheme may look all right on paper, but I may, like a writer in *The Daily Telegraph*, "be permitted to entertain a doubt."

Doubtful Advantages

All along the South Coast listeners are even now complaining of poor reception of the National transmissions. Complaints are strongest in Kent, where people rely on the London National transmitter. Is it to be expected that they will secure happier results when restricted for their National programmes to the Droitwich transmitter?

Maybe, or maybe not.

High Power at the New Northern Stations

I hear that work on the new transmitters will be begun before the autumn of next year, when Droitwich enters into regular service, so that Scotland and the North generally may expect the new era of powerful reception by midsummer, 1935. Both North Eastern and North Scottish will have an aerial power of not less than 75 kW.

Their's But to Do or Die

THE spirit of the Inquisition is afoot in Broadcasting House. From personal friends among the staff, I learn that the utmost surprise has been occasioned by the circulation of a form requiring them to give a more or less complete record of their careers since leaving school.

What is the motive behind this?

And Across the Channel

Contact with wireless seems to stimulate this inquisitorial habit. A Paris friend tells me of the dissatisfaction among French listeners at the number of questions which have to be answered before a listener can secure the now necessary wireless licence.

Desperate Case

The other day a prospective French licensee, goaded to desperation, sent his local postmaster an application for a licence together with the following information: "I was born on the 31st July, 1899, at ——. I married my wife, who is a blonde, on the 30th September, 1920. Of my six children, the three first have had measles. My grandparents are dead, likewise my father, but my mother survives. My father-in-law was a Brussels sprouts merchant. I trust these particulars will be helpful in the collection of the radio tax."

Off to Canada

WITHIN a fortnight's time Mr. Malcolm Frost will start off for Canada to blaze the trail of Empire broadcasting over there. He will take with him copies of the eleven records which he has already successfully disposed of in South Africa, Australia, and other parts of the Empire.

More Canned Programmes

On his return from Canada, Mr. Frost will, I understand, superintend the production of more records. These "canned" programmes, representative of the best types of B.B.C. transmission and ranging from radio drama to vaudeville, have infused new blood into the Empire and Colonial programmes, and have actually helped to raise the standard of local production.

More "America Calling"

AS in the case of his previous effort, Eddie Pola's projected programme for November 16th and 17th, "America Calling Again," is a burlesque on American broadcasting. Dave Burns will impersonate Jack Pearl as "Baron Munchausen," America's foremost Dutch dialect comedian who created the expression, "Vass you dare, Sharlie?"

Other artistes who will be impersonated are Al Jolson, The Mills Brothers, and Bing Crosby. The Mills Brothers will be impersonated by the Moderniques and Bing Crosby by Al Bowley. Eddie Pola will again appear as the announcer.

Anyway, It Got There

A READER writes: "When Mr. Martin Hussingtree wrote 'The Wrong 'Bus,' the little thriller which the B.B.C. broadcast the other evening, did he intend that the omnibus should be gearless? Either the 'Effects' 'bus had no gears, or it made a marvellous getaway on top."

How do I know what was in Mr. Hussingtree's mind?



DISTINGUISHED VISITORS. "Radio City," New York, was recently visited by Marchese Marconi. This photograph, taken on the roof of the Rockefeller Building, shows (left to right): Mr. M. H. Aylesworth, President of the N.B.C., Mr. Hugh S. Robertson, Marchesa and Marchese Marconi, Mr. David Sarnoff, President of the R.C.A., and Col. Arthur Woods, President of the Rockefeller Centre.

UNBIASED

BY FREE GRID

Droll Remark

IN a recent case in America in which the finances of a small wireless firm were being investigated, it was stated by counsel that the company in question had been able to keep afloat in spite of a devastating fire which had occurred at the works.

We are accustomed to judicial humour, but, at the same time, I thought that it was in rather bad taste for the judge to suggest that learned counsel had been guilty of a slip of the tongue by using the words "in spite of" instead of "owing to."

Epoch-Making

SUCH remarkable progress has been made in radio-technique during the past few years that I hesitate to draw attention to any particular discovery and to apply the hackneyed but exceedingly expressive term "epoch-making" to it. However, common justice to an inventor demands that I must.

The discovery, which is truly breathtaking in its very audacity, is reported in one of the more progressive of our great newspapers, and is to the effect that a citizen of the no mean city in which this particular journal circulates made the remarkable discovery that a loud speaker could be "worked with a signal current passed through a human body." In other



Tears rolling down my bib.

words, by disconnecting one terminal of the loud speaker and grasping it with one hand and the wire with the other, signals could still be heard; and, just to show that there was no deception, this miracle was demonstrated to a reporter of the paper concerned.

Now, I have to confess that when I first read this account I nearly did a grave injustice to the inventor, for I erroneously thought that I had read something like it years before; indeed, I had a distinct recollection of the tears rolling down my bib when I first saw the stunt performed by my mother. But I was wrong, and humbly apologise for it.

My mother, ardent experimenter that she was, merely did it by clutching at one wire, but she has been left far behind, for, although it is admitted that it has been done previously with one wire, the epoch-making discovery has been made that it can still be done even if a number of wires are grasped in the hand.

My Distinguished Reader

JUDGES are notoriously conservative in their outlook, and are apt to look upon all the great discoveries of science with the codfish eye of suspicion, as witness their repeated and plaintive demands: "What is a double-diode-triode?"

It is quite evident, however, from recent evidence which has come to light that this attitude of mind is fast waning, and that judges are beginning to "take cognisance" of things outside their immediate ken, even to the extent of reading the few humble words which I pen every week in *The Wireless World*. The case in question was one in which a gentleman was accused of the police of breaking into a place of entertainment and rifling the safe, the sole evidence for this outrageous charge being that the police happened to discover a finger print which corresponded with that of the gentleman. The police alleged that the chances were four billion to one against anybody else possessing a similar finger print, and, since there were not four billion people in the world, they regarded the case as proved.

His Lordship, however, mindful of the great finger-print controversy which raged in my columns twelve months ago, thought otherwise, and said so in no uncertain terms in his summing-up, with the result that the gentleman was found guiltless and discharged.

It is truly astonishing and, indeed, somewhat terrifying to think that, had not the judge read the irrefutable evidence which appeared in *The Wireless World* last year to the effect that finger prints can be forged, a fellow-man would even at this moment have been enduring all the discomforts of sleeping without a mattress, which I can assure you from personal experience is no light matter.

Stock Replies

THERE are many queer ways in which ardent collectors indulge in their passion, and I suppose that the postage stamp malady is really the most common of them all.

But the most curious of all the collecting hobbies is that indulged in by a sturdy Lancastrian who was my stable companion when journeying down from Manchester to London the other day. Our conversation had passed naturally and easily from horse-racing to radio, and this led directly

to my friend telling me of his particular collecting mania, which was to acquire a complete set of the innumerable stock letters which the B.B.C. send out to all their correspondents. The Corporation has, so he alleged, a stock reply to suit every conceivable question under the sun, and it is his one ambition in life to frame a letter in such a manner that none of the stock replies will do, and a special letter will become necessary. So far, however, he has been baffled in all his efforts, with the result that he now has several trunk-loads of stock letters which, according to a direction in his will, shall pass to the nation on his demise. But he still has hopes of fulfilling his ambition to drag a special letter out of Portland Place before he passes finally into the hands of the mortician.



So far he has been baffled.

He has so fired my imagination that I am even tempted to have a go at the game myself. It must be far more exciting than collecting bookmakers' demand notes or publishers' "rejection slips," in which so many people wantonly indulge nowadays.

At present the gem of my companion's collection is a stock letter sent from Savoy Hill many years ago, and signed by my old friend Captain Eckersley at a time when he and I were in America together.

When Ignorance is . . .

I SEE that a well-known scribe is urging his readers to take up the B.B.C.'s new German course on the grounds that the knowledge so obtained would be "particularly valuable in touring the Continent."

Speaking from a fairly wide experience of touring the Continent, I must say that, more often than not, a lack of linguistic knowledge has often been even more valuable to me. In particular, I have found, when travelling in a German Schnellzug without the necessary supplement, that a wooden expression and a bland "ignorance" on my part of any other language than Sanskrit has often reduced the ticket inspector to a nervous wreck and enabled me to get away with it, while others similarly situated but foolish enough to trot out a few halting phrases learned from the B.B.C. have been badly stung.

Further Notes on the New Monodial Super

The Alterations Needed for the British Heptode

WHEN the New Monodial Super was described in *The Wireless World* the only Pentagrid valve available was of American origin, and it was employed owing to the undoubted advantages of this type of valve over the only alternative—the conventional two-valve circuit. A British equivalent, the Ferranti VHT4 Heptode, however, is now made, and many requests have been received from constructors for an indication as to its suitability. Tests have been carried out with many different specimens, therefore, and it may be said at once that it has been found to be an entirely satisfactory alternative to the 2A7.

Fortunately, the valve is designed to operate with the same applied voltages, except on the heater, which follows the standard British rating of one ampere at 4 volts, so that changes in the anode and screen supplies are unnecessary. The only alterations from the original specification which are required in order to use the new valve, therefore, are the omission of the 2-ohms heater resistance (R3 on the original circuit diagram) and the replacement of the American valveholder by a 7-pin British type. If the Clix chassis mounting type be used, no change is needed in the size of the hole in the chassis.

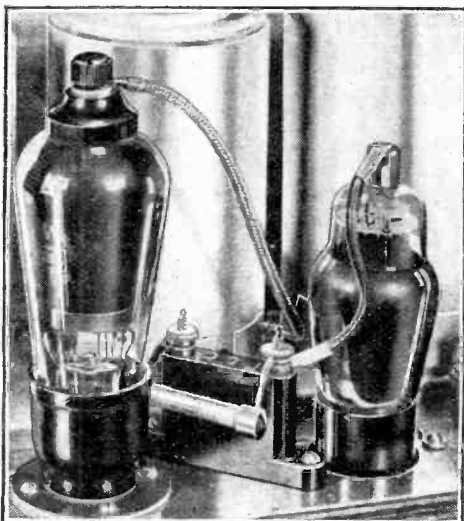

The 2A7 valve originally used in the New Monodial Super is shown here. The employment of the Heptode involves little alteration.

The control grid of the tetrode portion of the valve is connected to the terminal on the top of the bulb, as in the American type, but the connections to the valveholder are arranged differently. In order to avoid any chance of error, therefore, a practical wiring diagram of the

By
W. T. COCKING

THE use of a British frequency-changer valve in the New Monodial Super is dealt with in this article, together with questions arising through the use of a different output stage. Indications as to testing procedure are also given.

appropriate portion of the receiver is included with this article. The performance of the receiver with the British valve is in no way different from that with the 2A7, and the instructions for ganging and operating the set which were given in the constructional articles still hold good, and without any amendment. It is felt, however, that some further general notes may prove helpful.

Alternative Output Stage

Many builders are desirous of using the new receiver chassis in conjunction with the $2\frac{1}{2}$ watts or 5 watts power chassis of the original Monodial. So far as voltages and currents are concerned this is permissible, and no alteration is necessary either to the receiver or the power chassis. In order to maintain the correct loading on the low-pass filter, however, a 10,000 ohms 1 watt resistance should be connected across the L.F. transformer primary. As the output stage with one of these older power units is not of the push-pull type, the possibilities of L.F. feed-back are increased, and there is some risk of motor-boating. It is a wise plan, therefore, to increase the capacity of the second detector anode circuit decoupling condenser C21 to 8uF; if an electrolytic condenser be used, ample space for mounting it on the chassis is available.

Should motor-boating occur when using the push-pull output stage it will be evident that it is a sign of an unusual amount of L.F. feed-back. It is, therefore, indicative that one of the output valves has become defective, and that the output stage is no longer correctly balanced. Some care in diagnosing the cause of the trouble should be taken, however, since an audible effect very similar to motor-boating, and thus likely to be mistaken for it, can occur through a very different cause.

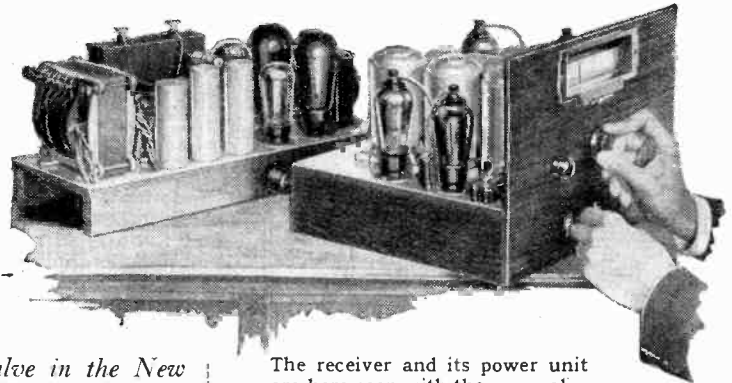

The receiver and its power unit are here seen with the new valve in situation

Should H.F. or I.F. instability be present in any receiver fitted with A.V.C. the audible effect is almost indistinguishable from motor-boating. This is readily understandable when it is remembered that self-oscillation leads to a large detector input, and this in turn means a large bias on the controlled valves. As a result, these stages stop oscillating, the detector input drops, and the bias returns to its normal value, when instability once more sets in and the whole cycle is repeated.

Instability in a receiver such as the New Monodial, of course, is an unlikely event, but it may be useful to indicate the danger points which may be found not only in this set, but in any superheterodyne. The first is the gang condenser, for it is essential

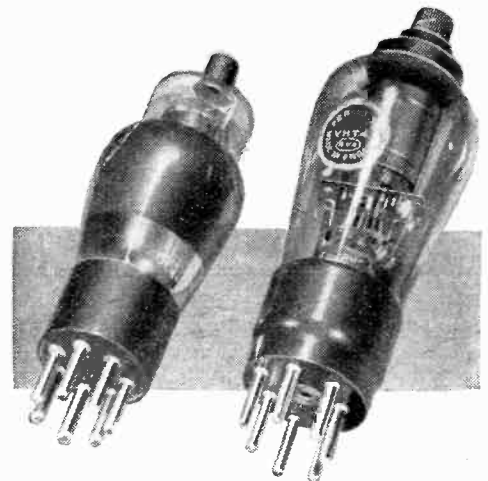

The 2A7 valve is shown on the left and the VHT4 on the right; the different arrangement of the pins can clearly be seen.

that the frame of this component be earthed at each end. If it is not, the single earth connection will act as a common coupling to the signal frequency circuits, and instability, poor ganging, and a low degree of preselection will be found. The second danger point is the anode circuit of the frequency changer, for this lead must not be allowed to pass close to the H.F. valve or any of its grid circuit components. A spacing of at least two inches

Further Notes on the New Monodial Super— between the anode lead and the H.F. valve circuits must be allowed.

Testing and the A.V.C. System

Apart from such obvious errors as poor connections, no troubles are likely other than through the unfortunate event of one of the components proving defective. Should this occur its tracing may be hampered by the A.V.C. system, so that it is

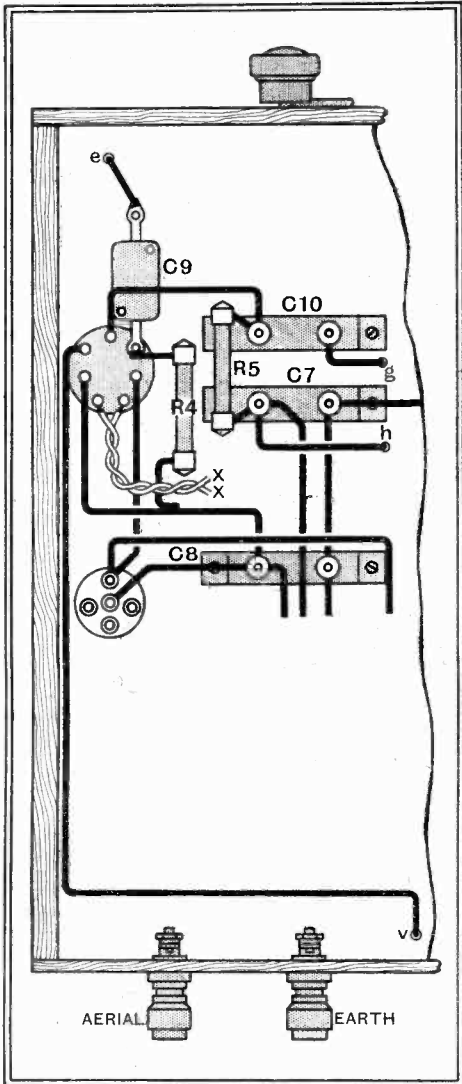

The practical wiring diagram of the frequency changer portion of the set embodying the British valve.

a great help to be able to cut this out of circuit. This may readily be done by short-circuiting C15, and by placing the local-distance switch at local the noise suppressor resistance R9 may be used as a manual sensitivity control. The receiver then functions without A.V.C., and its performance may more easily be judged by those unaccustomed to handling a set fitted with automatic volume control.

A specimen receiver, with the necessary alterations from the original model for the inclusion of the Ferranti VHT4 Heptode, is available for inspection at 116, Fleet Street, London, E.C.4.

Interference

Progress of I.E.E. Committee's Investigation

The Committee on Electrical Interference with Broadcasting set up by the Institution of Electrical Engineers held its second meeting on Thursday, October 5th. This Committee, it will be remembered, was set up as a direct result of the recommendation put forward by "The Wireless World" in November last, that the I.E.E. was the proper body to undertake the task, as being truly representative of the electrical industry of this country.

SINCE the last meeting of the Main Committee, four sub-committees, we are informed, have been engaged on the consideration of means which might be adopted and the cost of such means to render future plant and appliances non-interfering. Consideration has also been given to possible methods for dealing with interference apart from suppression at the source.

The report of the sub-committees was considered in detail and accepted. The investigations have included such items as lifts, trolley omnibuses, domestic appliances, and other apparatus.

The work of the sub-committees indicates that devices for the suppression of interference from many items of electrical plant, particularly domestic appliances, could be incorporated in future designs at a reasonable cost. Further investigation is necessary on some of the larger items of plant, and tests of a quantitative nature are being carried out by the British Electrical and Allied Industries Research Association on such items.

The Committee reviewed various possibilities of bringing suppression devices into general use without having recourse to legislation.

It was emphasised that for the suppression of much of the electrical interference which exists at present, goodwill and co-operation will be necessary among a large number of interests.

Pending the result of the further investigations which are now being carried out, it was agreed that co-operation should be sought with the manufacturers and other interests affected on the basis of the interim report of the sub-committees, and efforts are being centred in this direction. Consideration was also given to the possibility of international action on the question of electrical equipment embodying suppression devices, and arrangements were made for a British National Committee to be set up to consider this question.

The Radio Industry

A USEFUL little accessory for use with Henley's Solon soldering-iron has just been introduced. Known as the Solon Solder Pot, it is intended for clamping on the body of the iron, where it will maintain a sufficient quantity of solder in a molten state for tinning the ends of wires, etc. It costs one shilling.

Mr. R. J. Durand, late of the B.B.C., who was in charge of the reproducing equipment at the Olympia, Manchester, and Glasgow exhibitions, has now joined the City Accumulator Company. He is to take charge of the C.A.C. showrooms at 4, Surrey Street, Strand, London, W.C.2.

Philips are now marketing a loud speaker and a pick-up; the former is of the permanent magnet type and is supplied with suitable transformers for pentode, triode, Class "B" and Q.P.P. output valves.

A newly formed company, the Marine Electrical Equipment Co., Ltd., Gambrell Works, Merton Road, Southfields, London, S.W.18, is producing a series of radio-telegraphic and telephone transmitters for commercial service. The apparatus, which is fully described in a booklet just received, includes complete ship

sets, and also low-powered radio-telephone installations for fishing craft and yachts, as well as direction finders and lifeboat equipment.

It is significant that the firm of E. K. Cole, Ltd., which has always concentrated on mains-operated-receivers, are now producing a battery-operated version of their well-known seven-stage superheterodyne. Recent technical improvements in battery-fed output stages are responsible for this change of policy.

Ferranti's announce the introduction of a new superheterodyne—the Lancastria Magna at 15 guineas. The smaller original model is now known as the Lancastria Parva, and costs 13½ guineas.

Change of Address
Mavox Radio, Ltd., from 17, Maddox Street, London, W.1, to 21, Store Street, Tottenham Court Road, London, W.1. (Museum 9228.)

Catalogues Received
British Insulated Cables, Ltd., Prescot, Lancs.—B.1 wireless condensers.
S. Smith and Sons (M.A.), Ltd., Cricklewood, London, N.W.2.—"Anodex" dry batteries.
Siemens Electric Lamps and Supplies, Ltd., 38-39, Upper Thames Street, London, E.C.4.—"Full-o-Power" radio batteries.

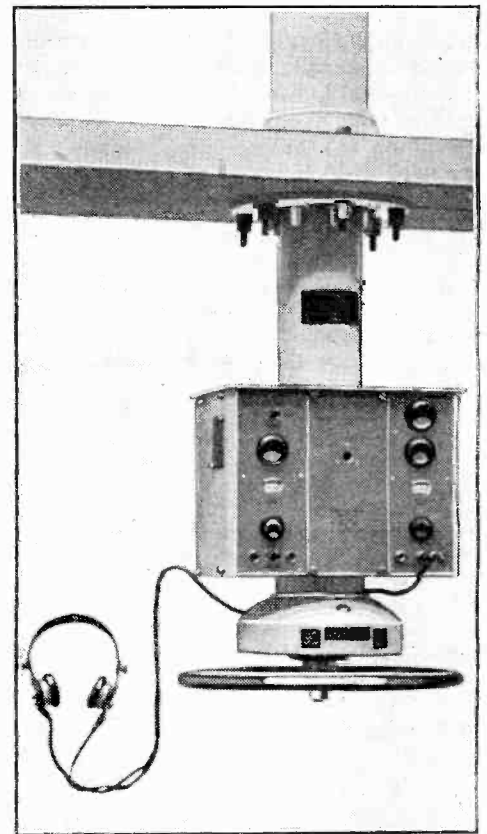

The Marine Electrical Equipment Company's direction finder, with receiver unit mounted on the column supporting the rotating loop.

Wilkins and Wright, Ltd., Holyhead Road, Birmingham.—"Utility" condensers and other wireless components.

British Ebonite Co., Ltd., Hanwell, London, W.7.—Price list of ebonite panels, rods, tubes, etc.; also "Handbook of Tuning Coils," with illustrations and winding data.

Amplion (1932), Ltd., 82-84, Rosoman Street, Rosebery Avenue, London, E.C.1.—Amplion loud speakers and components.

Trevor Pepper, 48, Wake Green Road, Moseley, Birmingham.—"Seradex" eliminators, battery chargers and rectifiers.

Chas. A. Osborn, 21, Essex Road, Islington, London, N.1.—Radio cabinets.

Webb Condenser Co., Ltd., 42, Hatton Garden, London, E.C.1.—Variable condensers and components.

Telsen "464" Receiver

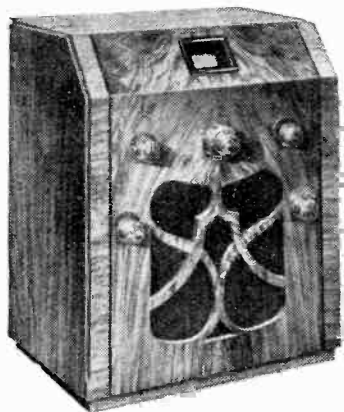

FEATURES. *Type.*—Table model A.C. mains receiver for use on outdoor or mains aerial. *Circuit.*—H.F. pentode stage with iron-cored tuning coils—grid detector with reaction—power pentode. Full-wave valve rectifier. *Controls.*—(1) Main tuning (with trimmer). (2) Wave-range. (3) Reaction. (4) Selectivity control. (5) Tone control. *Price.*—9 guineas. *Makers.*—Telsen Electric Co., Ltd., Aston, Birmingham.

A Well-finished Receiver at a Low Price

ONE of the first things to attract attention in view of the very reasonable price of this receiver is the exceptionally good finish and clean workmanship. From this point of view it will bear the closest examination not only in the cabinet work, but in every detail of the chassis.

The bright-finished steel framework of the chassis is proportioned to give a neat and compact layout, and is unusually rigid, the edges of the metal having been turned up for strength in the bending process. The chassis is held in position in the cabinet by rubber-bushed screws in the base, and is pulled up to the front panel by additional bushed screws passing through extensions of the side members. A rubber ring makes an effective seal between the periphery of the moving-coil loud speaker and the cabinet.

The loud speaker is of slightly larger dimensions than usual, and the sound output, both from the point of view of volume and quality, would do credit to a set of far higher price. A tone control is fitted, and with this set towards the "high" position the reproduction is clear and crisp. There is very little background noise or mains hum, and this undoubtedly adds to the effect of realism.

A "straight" three-valve circuit has been adopted, and the H.F. stage includes iron-cored coils and one of the latest H.F. pentode valves. An all-metal "Catkin" valve is used in the detector stage, and is followed

by a power pentode output valve. The rectifier is a full-wave standard valve of the "Micro-mesh" type.

There are two tuned circuits, and the ganged tuning condenser is provided with an auxiliary trimmer controlled by a spindle passing through the main control knob. Both tuned circuits are arranged as loose-coupled transformers, and reaction is applied to the intervalve circuit from the detector. To assist selectivity, a series variable condenser is connected in the aerial lead. This is automatically short-circuited in the maximum position in order that the full sensitivity of the set may be available under conditions which do not call for a higher degree of selectivity.

We were particularly impressed by the

sensitivity, and for a set of its type the range is definitely above the average. Many of the medium-wave stations, such as Brussels, Langenberg, and Fécamp, came through in daylight with as much volume as many three-valve sets give under night conditions.

As regards selectivity, care must be taken to see that the tuned circuits are accurately aligned, otherwise the performance in this respect might be easily misjudged. However, with due care in tuning and by close

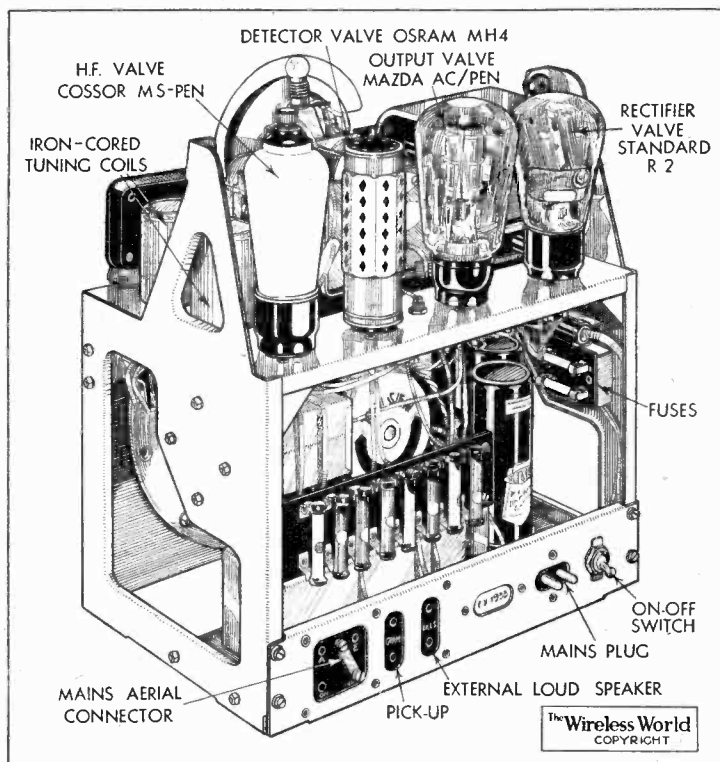

The pressed-steel chassis forms a compact and rigid unit.

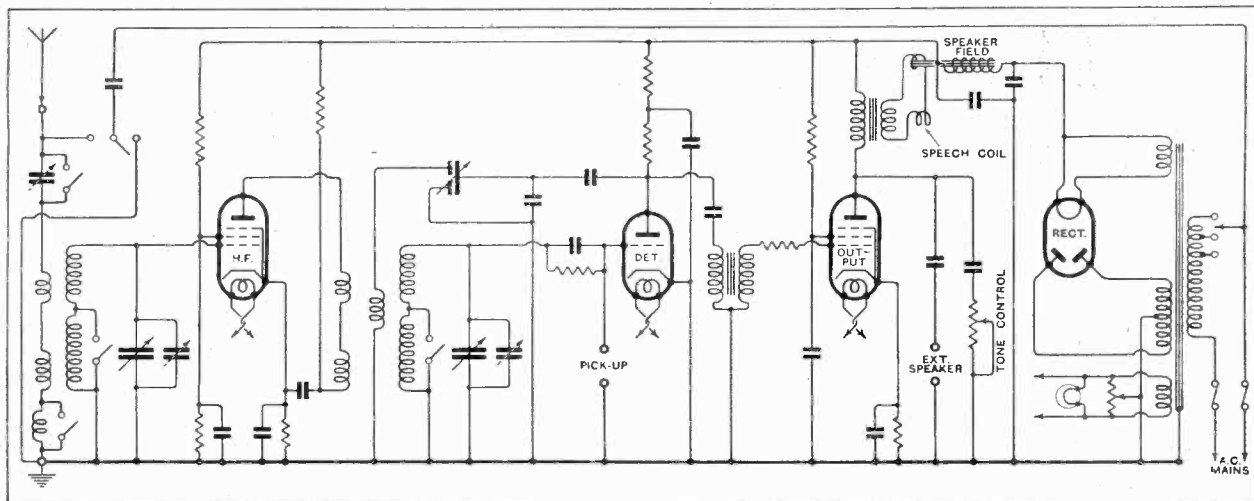

Complete circuit diagram. The coil at the bottom of the aerial coupling circuit is inserted to prevent break-through of medium-wave stations on long waves.

attention to the adjustment of the "Separator" and reaction controls, the London National and Regional transmitters could be confined in central London to band widths of 230-280 and 300-390 metres respectively.

On long waves Daventry and Radio-Paris can be tuned-in clear of each other.

There can be little doubt that this set will more than satisfy the requirements of the man of limited means, and from the point of view of quality of workmanship and material it is fit to be ranked with sets of much higher price.

NEXT WEEK'S SET REVIEW:
SUNBEAM MIDGET

Letters to the Editor:—

Valves or Stages ?

Electrostatic Speakers : Ohms per Volt : Output

The Editor does not hold himself responsible for the opinions of his correspondents

Valves or Stages ?

THE recent correspondence between Mr. Baggs and Mr. Barry Kay cannot be other than inconclusive if conducted on its present terms. Mr. Baggs maintains that, since nomenclature by both valves and stages must be misleading in respect of many details of design, it would be better to leave even the main framework of receivers altogether unspecified. Mr. Kay, on the other hand, apparently intoxicated with the ingenuity of the new designation, does not seem to envisage the fuller description of sets, but rests content with a considerable degree of vagueness.

A parallel may be drawn from the case of motoring. Those who held that cars should only be advertised on the basis of the number of their cylinders could never be made to agree with those who held the same view in respect of their horse-power. In either case it is clear that what is wanted is not alternative erroneous systems, but a fuller system which can give rise to no misapprehensions. The number of valves is necessary to give an estimate of costs of replacement; the number of stages, an estimate of performance.

But it is also clear that radio sets have now become such complex pieces of machinery that even the conjunction of valves and stages cannot adequately describe their abilities. If nothing were known about a certain car save that it had eight cylinders, it could not be positively affirmed that it was better than another car with two, for the relative efficiencies with which these cylinders were used might differ widely. Similarly, a four-stage set might be very inferior to a three-stage set if the first contained a detector and three low-frequency stages, and the second was a normal I-V-I. The motoring public has set itself to master the intricacies of differing design, and is now well acquainted with fluid flywheels, automatic clutches, self-changing gear boxes, and so forth. There is no reason why the ignorance of the radio public, if such ignorance exists, should be pampered and encouraged. If it does not exist, there is still less reason.

There is no danger of misunderstanding in providing figures for the sensitivity, selectivity, and degree of automatic volume control, of all receivers. In America, the input-output ratio for the first figure has been related to a standard base; selectivity can be defined in terms of the detuning in kilocycles required to reduce a signal by a given proportion; while the effect of A.V.C. may be displayed by a simple graph. All these factors are within the understanding of the public, if they were carefully explained. Nothing but harm can arise from hazy and ill-defined statement. This type of error is well exemplified in the mention, criticised by "Free Grid," and made by Mr. Taylor, and no less an authority than Messrs. Ferranti, of "anode-to-cathode-streams." The reversal of these streams would, I feel sure, require the exercise of as great Authority as once reversed the waters of the Red Sea.

R. J. SPOTTISWOODE.

Oxford.

Electrostatic Speakers

MANY thanks to WIRELESS WORLD and Mr. Scroggie for the excellent articles on the electrostatic speaker; a device which until now, in my opinion, has not received the attention it deserves. Experience has shown me that there is one practical point which it is very easy to overlook when designing a dual speaker combining electrostatic and moving-coil speakers. It is that on no account should the distance between the two units be less than 2 1/4 in. from edge to edge.

It will be readily appreciated that when the electrostatic unit is in close proximity to the moving coil, its diaphragm will be, in effect, part of the baffle board, and, in consequence, considerable differences of air pressure generated by the moving coil will be developed on either side of it, with the result that the distance between diaphragm and fixed plate will vary at low frequencies. At first sight it would appear that this movement will only result in loss of radiation by the moving-coil speaker and possible rattle; but further consideration shows that, since the capacity of the electrostatic unit will be varied at low frequency, any notes reproduced by it will have their intensity modulated by the bass—a distinctly unpleasant effect which is all too common in the reproduction given by cheap moving-coil speakers with speech coils of very short winding length concentrated in the magnet gap to extract the last decibel of noise with an inadequate field density. L. H. MOORE.

Liverpool.

Ohms per Volt

THE question of terminology is frequently raised in your columns, and, as far as I can see, the definitions and terms used by *The Wireless World* are those generally accepted by the Trade and the Technical Press.

Nevertheless, there is one expression used by yourselves and manufacturers to which a practical engineer may take exception; that is, the *ohms per volt* specification applied to voltmeters.

Taken literally, the description of a meter as 500 ohms per volt implies that a resistance of 5,000 ohms is in circuit at a reading of 10 volts, and of 50,000 ohms at 100 volts. Unfortunately, not all those connected with either the amateur or professional sides of wireless know how far this is from the truth, and that, provided the same meter or scale be in use, the resistance in circuit is the same in each case.

The vast majority of "voltmeters" are basically "current reading instruments," the internal resistance in series within the meter is determined by the maximum current reading and the maximum voltage to be measured. From this aspect the resistance as a specification would only be useful when coupled with the full-scale voltage reading. With it, a 100,000 ohms/500 meter would be equivalent to a "200 ohms per volt" meter. Though it would specify the

meter more definitely it would be clumsy, and would not immediately convey the information the engineer requires.

As both these terms depend entirely on the current taken by the meter at full-scale deflection the "goodness" of a voltmeter could be expressed much better by that current, and, so that there could be no misinterpretation, the fact that it is the *maximum* current could be added. What I suggest is that the above meter be specified as a "5 mA. max." meter.

The current taken at any voltage can be expressed by the formula:—

$$\text{Current} = \frac{\text{voltage reading}}{\text{full-scale reading}} \times \text{max. current.}$$

Thus, a reading of 50 volts on a "5 mA. max." meter with a full scale of 250 volts means that a current of 1 mA. is flowing.

The service engineer and the set constructor are often faced with the problem of the change in circuit conditions brought about by the insertion of a voltmeter into the circuit. As the estimation of the change is more easily calculated in terms of current flowing through the circuit resistances, the use of the above terminology would simplify matters considerably. The formula would be equally simple:—

$$\text{Voltage change} = \frac{\text{voltage reading}}{\text{full-scale reading}} \times \text{max. current} \times \text{resistance.}$$

This, of course, is neglecting any change brought about by the alteration of the D.C. resistance of the valve or valves in parallel with the meter.

I venture to suggest that the majority of engineers and constructors would welcome this simplification of our terminology, particularly when it also makes it more explicit.

London, S.W.5. W. MACLANACHAN.

Output

THE following apparent fallacy may be of some interest to readers. Assume a power valve capable of a maximum undistorted output of 4 watts, with grid bias = 50 volts. If two such valves are connected in parallel, the maximum undistorted output will be 8 watts, so that if an A.C. voltage of 25 volts (peak) at frequency f_1 be applied to the grids, the output will be 2 watts, since output is proportional to the square of the volts applied to the grid. Now apply another 25 volts (peak) at frequency f_2 at the same time as the first. There will be then 2 watts of f_1 and 2 watts of f_2 in the output, making 4 watts in all, and in addition the valve grids will be fully loaded with 50 volts peak. On the other hand, if the valves are operated separately with 50 volts of f_1 on one grid, and 50 volts of f_2 on the other, each valve will give its full 4 watts output, and if these are combined there will be a total of 8 watts.

Under both conditions the valves are fully loaded, yet by separating the frequency components double the output is obtainable. The fallacy is obvious, but the example given is a strong argument for the use of a double output stage when separate high or low note speakers are used, unless, of course, the transmission is heavily modulated with one frequency only.

Persia.

LEAD-IN.

Correspondence should be addressed to the Editor, "The Wireless World," Dorset House, Stamford Street, S.E.1, and must be accompanied by the writer's name and address

New Apparatus Reviewed

Latest Products of the Manufacturer

BRITISH GENERAL ALL-WAVE TUNER

THE British General Manufacturing Co., Ltd., Brockley Works, Brockley, London, S.E. 4, who for long past have included an aerial unit giving continuous tuning from 200 to 2,000 metres in their range of components, have now further extended the idea and introduced an all-wave model covering the short, the medium and the long wavebands. The new tuner consists of a moulded former 6½ in. long with the various windings spaced sufficiently far apart to ensure that the idle sections have very little effect on the portions in use.

Two switches are included; the upper one is the wave selector and has four positions, two being for the short waves and one each for the medium and the long waves. Below this is a selectivity switch which changes over the aerial to different tapings on the coil; it also has four positions.

The ranges covered by a 0.0005 mfd. tuning condenser are from just below 15 metres to 29 metres with the switch on S1; 26 metres to 76 metres on S2; 195 metres to 550 metres on M, and 835 to 2,220 in the L position. Reaction was satisfactory throughout, but a 0.0005 mfd. reaction condenser is necessary.

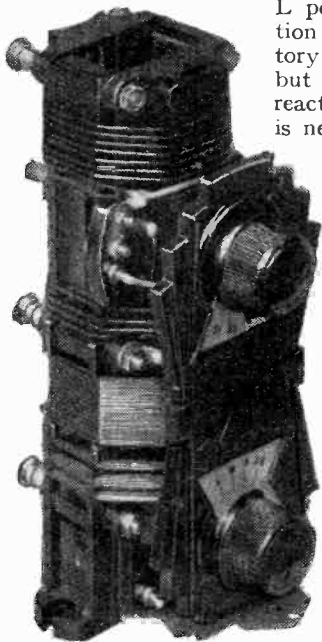

British General all-wave tuner covering short, medium and long waves.

An H.L. two-volt type valve gives good results as a detector and enables smooth regeneration to be obtained. Only at the higher condenser settings on the short waves was reaction uncertain. There is, however, an adequate overlap. The price is 9s. 6d.

A NEW BAKER UNIT

BAKER SELHURST RADIO have added to their range of moving-coil units a new model which will be known under the name of "Justone." It is constructed on the lines of the well-known "Permag" unit, and is fitted with a multilayer speech coil, which enables comparatively lower transformer ratios to be employed. This results in less leakage inductance, and a consequent improvement in high-frequency response.

The most important feature of the new unit is, however, the multi-ratio output transformer, which gives twenty ratios for

single-output valves and four for push-pull combinations, including Class "B" and

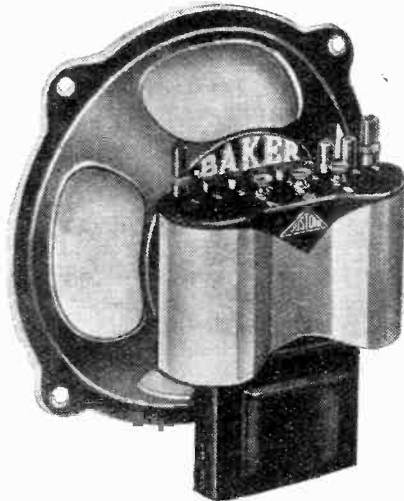

The new Baker Selhurst "Justone" loudspeaker with 24-ratio output transformer.

Q.P.P. Alteration of the ratio gives a wide variety of frequency responses, and the user can readily modify the quality.

The price of the unit in chassis form is 45s., and cabinet models are also available.

The makers are Baker's "Selhurst" Radio, 75-77, Sussex Road, Croydon.

R. I. MICRION COIL

THIS new coil recently introduced by Radio Instruments, Ltd., Purley Way, Croydon, embodies a core of a specially prepared iron-dust alloy described as "Micrion." It is a screened dual-range coil intended to serve for aerial or H.F. coupling, and is provided with a tapping on the medium wave section for the aerial lead and a separate reaction winding. Waveband switching is not included.

The special feature of the coil is that the inductance of each section can be varied within certain limits by altering the position of the cores within their respective bobbins. This adjustment, effected by two small screws protruding through the side of the screen, gave an inductance variation of 160 to 180 microhenrys approximately for the medium wave coil and from 1,570 to 1,930 microhenrys for the long wave section in the case of the specimen tested.

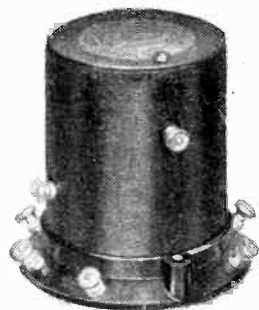

R.I. Micrion coil embodying permeability adjustment of inductance.

coils to be used in the same circuit and their inductances matched for single dial tuning.

Our tests show the coil to be a particularly efficient one, and definitely better than a first-grade air coil of the familiar screened pattern. Compared on a basis of dynamic

resistance values, the Micrion coil is about 40 per cent. better on the medium waveband and of the order of 30 per cent. on the long waves.

It should prove very convenient as a replacement coil where an air type one with external switching is now used, for the change-over can be effected with little trouble, and a worth-while improvement in selectivity and sensitivity will follow. The price is 12s. 6d.

CORREX MICROPHONE

A MICROPHONE that is particularly well suited for use with public address amplifiers is the model HB, introduced by the Correx Amplifiers, 21, Marmora Road, East Dulwich, London, S.E. 22. It is of the carbon pattern mounted in a strong rectangular metal case measuring 3½ in. x 3 in. x 1½ in. and being of a sensitive type requires to be mounted in a vibration free holder. The makers have adopted a suspension consisting of four coil springs in a metal frame carried on a telescopic stand of which two kinds are available; one is for table use and the other a floor model. These are strongly made and finished in grey and chromium.

The microphone operates satisfactorily with four volts D.C. and passes about 20 mA., thus a small dry battery will suffice to supply the polarising voltage. An input transformer with a ratio of 1 to 30 is required. On test the frequency response was

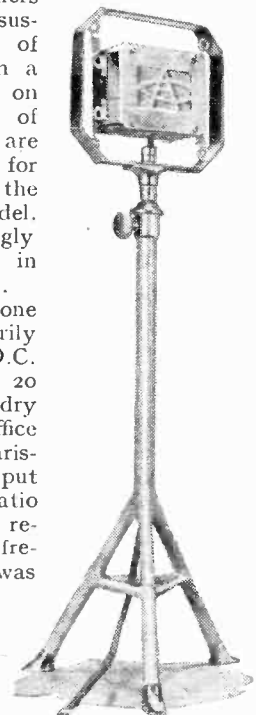

Correx carbon microphone and adjustable table-type stand.

found to be very good indeed, speech is clear and crisp and voices are easily recognisable. Although the microphone is quite sensitive it does not give a large output, the mean level being somewhat lower than that of an average pick-up. We found one additional stage of amplification desirable.

It is a particularly good example of the high standard now attained by the carbon microphone, and in view of its efficiency is not expensive at £6 10s. The stands cost £3 15s. in table form and £4 10s. for the floor model, while the input transformer costs 18s. 6d.

RONNIE SCIENTIFIC EARTH TUBE

IT would seem hardly necessary to point out that the mineral compound used in this tube, reviewed in these columns last week, is not injurious to metal, as the acid content of the copper sulphate preparation has been neutralised by a chemical process.

READERS' PROBLEMS

An Eleven-stage Set

THERE is a tendency to classify receivers by "stages" rather than by the number of valves: a querist asks how the New Monodial should be described under this rating.

In this receiver there are a total of six amplifying stages, but if the expression "stage" be interpreted as an electron stream in a valve in the accepted way, there are eleven stages.

Another recent question with regard to the New Monodial relates to the fixed condensers. All these of a capacity of 0.02 mfd. or less are of the mica-dielectric type.

Tuning Indicators

ALTHOUGH a milliammeter is perhaps too scientific a device to appeal to the general public, it is probable that it makes the best possible tuning indicator for the more knowledgeable enthusiast. At any rate, a number of readers have lately written to us on the use of a meter in this way; of course, the general adoption of A.V.C. has led to increased interest in visual tuning devices.

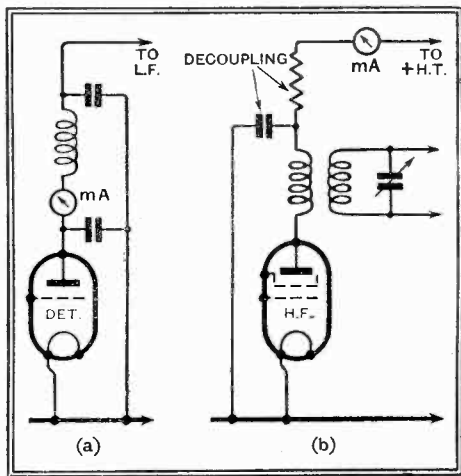

Fig. 1—Although often convenient, it is risky to join a milliammeter directly to the anode of a detector, H.F., or I.F. valve, as in diagram (a). The correct position is indicated in diagram (b).

One or two correspondents seem to have met with difficulties when adding a milliammeter to an existing receiver, but in every case their troubles may be ascribed to incorrect connections. The meter in question may be inserted in the anode circuit of the detector valve, or, more generally nowadays, in the anode circuit of one or more of the controlled valves. It should be emphasised that as a general rule it is dangerous to join the meter directly to the anode of the valve, as this course will very probably be productive of instability, or else it may upset ganging.

Connected as in Fig. 1 (a), in the anode circuit of a detector, the meter and its wiring will be at a high oscillating potential, and may cause excessive interaction with earlier stages. Again, it is often tempting to join the instrument directly to the anode cap of an S.G. valve acting as an H.F. or I.F. amplifier; here the risk of causing instability will be even more pronounced, and the capacity of the meter and its extra leads to earth will be additive to that already existing across the circuit.

THESE columns are reserved for the publication of matter of general interest arising out of problems submitted by our readers. Readers requiring an individual reply to their technical questions by post are referred to "The Wireless World" Information Bureau, of which brief particulars, with the fee charged, are to be found at the foot of this page.

The right position for the indicating meter is always at the low-potential end of the anode circuit (that nearest to the source of H.T. supply), as indicated in Fig. 1 (b).

Proportional Amplification

IT is asked whether the lower audible frequencies may be over-accentuated in a resistance-coupled gramophone amplifier by employing a larger coupling condenser than usual between the stages.

We are afraid that nothing can be done in a pure resistance-coupled amplifier to strengthen the relative amplification of low notes. Even if a coupling condenser of infinite capacity were employed, the bass register would not be amplified to a greater extent than the high notes.

But, although nothing we can do will strengthen the low notes, a similar result can be achieved by weakening the upper frequencies by fitting by-pass condensers in either the grid or anode circuits.

25-cycle Hum

EVERYONE expects to find it easier to smooth rectified current derived from a standard 50-cycle A.C. supply than that obtained from 25-cycle mains. This is due mainly to the fact that the ordinary smoothing choke is much more effective at the higher frequency.

But in actual practice things do not always work out entirely according to plan. For instance, we hear from a reader whose supply has just been changed from 25 to 50 cycles that hum is now very much worse than before, in spite of the fact that his mains transformer has been tested, and is found to deliver the correct voltages under the new operating conditions.

His difficulty is most probably caused by a loud speaker resonance at 100 cycles (which will be the principal hum frequency at the new periodicity), but there is a possibility that the noisier background is merely due to the fact that all loud speakers have a much better response at 100 than at 50 cycles.

The Wireless World INFORMATION BUREAU

THE service is intended primarily for readers meeting with difficulties in the construction, adjustment, operation, or maintenance of wireless receivers described in *The Wireless World*, or those of commercial design which from time to time are reviewed in the pages of *The Wireless World*. Every endeavour will be made to deal with queries on all wireless matters, provided that they are of such a nature that they can be dealt with satisfactorily in a letter.

Communications should be addressed to *The Wireless World* Information Bureau, Dorset House, Stamford Street, London, S.E.1, and must be accompanied by a remittance of 5s. to cover the cost of the service. The enquirer's name and address should be written in block letters at the top of all communications.

Repeating a Warning

THE difficulties described by a constructor of a superheterodyne receiver, in which an unconventional layout is employed, may almost certainly be ascribed to the use of unsuitable screened wire, with too much self-capacity, in the anode circuit of the first detector valve. The symptoms point to the existence of an excessive stray capacity in the first I.F. transformer.

According to our experience, difficulties in ganging and trimming are often due to the fact that high-potential H.F. or I.F. leads are run in ordinary commercial metal-braided cable of the type sold for motor-car wiring, etc. It is wise to make it a rule never to use this wire in any H.F. or I.F. circuit; the safest type of screened conductor to use consists of metal-braided sleeving of large diameter, the internal wire being as thin as possible consistent with mechanical strength.

The Loading Resistance

ONE or two readers are puzzled by the fact that, in the Ferrocart III receiver, a resistance which apparently serves no useful purpose is shunted across the smoothed output of the H.T. supply system; the resistance in question is marked R₁₅ in the original diagrams.

This is a loading resistance pure and simple. It happens that the anode circuits of the valves in this receiver require rather less than the full rated output of the eliminator, and the shunt resistance is therefore added in order to bring up the total load to that figure. It also serves another purpose; without it the energising current flowing through the speaker field which may be used as a smoothing choke would be less than is desirable for best results. As shown in Fig. 2, the resistance is so connected that current flowing through it, as well as the anode current for the valves, will also flow through the speaker field.

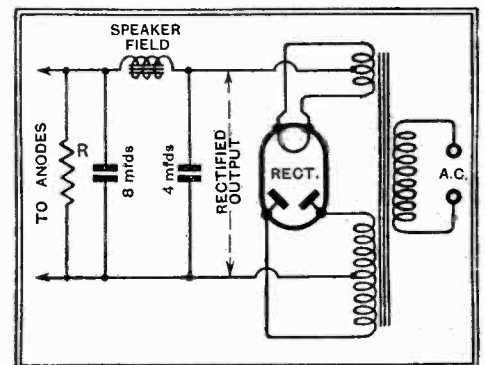

Fig. 2.—The artificial load resistance R prevents an undue rise in voltage and also ensures a sufficient flow of current through the speaker field.

It is often convenient to connect a load resistance in this way in order to prevent a rise in voltage. The necessary ohmic value is easily ascertained by dividing the desired output voltage of the rectifying equipment by "surplus current" (expressed as a fraction of an ampere). Surplus current is the difference between the estimated anode consumption of the valves, and the current at which the desired H.T. voltage will be maintained. The latter may be obtained from the valve maker's data.